

DX³ isolators

ISs for AC applications upto 125A



4065 00

4065 10

4065 20

Technical characteristics p. 45

Isolators for AC applications upto 125 A
 ISI marked as per IEC 60947-3
 Integrated label holder
 Ergonomic red color dolly
 Sliding bottom clamp
 Double break mechanism
 Improved air channels
 Color coded On/Off indication on dolly
 Biconnect lower terminals
 IP 20 protected terminals
 Sliding shutters

Pack	Cat.Nos	Isolators	Number of modules
		2 pole 415 V\sim	
		Nominal rating In (A)	
1/5/60	4065 00	32	2
1/5/60	4065 01	40	2
1/5/60	4065 02	63	2
1/5/60	4065 04	100	2
1/5/60	4065 05	125	2
		3 pole 415 V\sim	
1/40	4065 09	32	3
1/40	4065 10	40	3
1/40	4065 11	63	3
1/40	4065 13	100	3
1/40	4065 14	125	3
		4 pole 415 V\sim	
1/32	4065 18	32	4
1/32	4065 19	40	4
1/32	4065 20	63	4
1/32	4065 22	100	4
1/32	4065 23	125	4

DX³ RCCBs

RCCBs for AC applications upto 63 A



4118 51

4118 77

4118 93

Technical characteristics p. 46-51

ISI marked as per IS 12640-1
 Integrated label holder
 Ergonomic Grey color dolly
 Sliding bottom clamp
 Color coded On/Off indication on dolly
 Biconnect lower terminals
 IP 20 protected terminals
 35 sq mm terminals
 Sliding shutters

Pack	Cat.Nos	DX ³ RCCBs	Number of modules
		2 pole 240 V\sim	
		30 mA	
		Nominal rating In (A)	
1/5/60	4118 51	25	2
1/5/60	4118 52	40	2
1/5/60	4118 53	63	2
		100 mA	
1/5/60	4118 56	25	2
1/5/60	4118 57	40	2
1/5/60	4118 58	63	2
		300 mA	
1/5/60	4118 61	25	2
1/5/60	4118 62	40	2
1/5/60	4118 63	63	2
		4 pole 415 V\sim	
		30 mA	
1/32	4118 76	25	4
1/32	4118 77	40	4
1/32	4118 78	63	4
		100 mA	
1/32	4118 81	25	4
1/32	4118 82	40	4
1/32	4118 83	63	4
		300 mA	
1/32	4118 86	25	4
1/32	4118 87	40	4
1/32	4118 88	63	4
		4 pole 415 V\sim, A-S	
		300 mA	
1/5/60	4118 91	25	4
1/5/60	4118 92	40	4
1/5/60	4118 93	63	4
		2 pole 240 V\sim, HPI	
		30 mA	
1/5/60	4118 71	25	2
1/5/60	4118 72	40	2
1/5/60	4118 73	63	2
		4 pole 415 V\sim, HPI	
		30 mA	
1/32	4118 96	25	4
1/32	4118 97	40	4
1/32	4118 98	63	4

Technical data

Specifications	IS/IEC 60898-1 2002	
Number of poles	SP, SPN, DR, TR, TPN, FP	
Characteristics	C & D Curve	
Breaking capacity	10 kA 0.5 A to 63 A as per IS/IEC 60898-1 2002 16 kA for 0.5 A to 25 A as per IEC 60947-2	
Rated voltage	230 V/400 V	
Current limitation class	Class 3	
Frequency	50 Hz/60 Hz	
Minimum operating voltage	12 V AC/DC	
Enclosures	Polyester self extinguishing, heat and fire resistant according to IEC 60898-1, glow-wire test at 960 °C for external parts made of insulating material necessary to retain in position current-carrying parts and parts of protective circuit (650 °C for all other external parts made of insulating material)	
Mounting position	Vertical / Horizontal / Upside down / On the side	
Fixing	On symmetric rail EN/IEC 60715 or DIN 35	
Maximum cable size	Top/Bottom	1 x 1.5 mm ² to 35 mm ²
	Rigid cable	2 x 1.5 mm ² to 16 mm ²
	Top/Bottom	1 x 1.5 mm ² to 25 mm ²
	Flexible cable	2 x 1.5 mm ² to 10 mm ²
Applied connection torque	Recommended : 2.5 Nm Minimum : 2 Nm Maximum: 3 Nm	
Mechanical endurance	20000 operations without load	
Electrical endurance	10000 operations with load (under $I_n \cdot \cos \phi = 0.9$) 2000 operations under I_n , DC current	
Permissible ambient temperature	0.5 to 63A - Maximum + 70 °C Minimum -25 °C	

Specifications	IEC 60947-2	
Number of poles	SP, DP, TR, FP	
Breaking capacity	10 kA 80 A to 125 A as per IEC 60898 16 kA for 80 A to 125 A as per IEC 60947-2	
Rated voltage	230 V/400 V	
Current limitation class	Class 3	
Frequency	50 Hz/60 Hz	
Minimum operating voltage	12 V AC/DC	
Enclosures	Polyester self extinguishing, heat and fire resistant according to IEC 60898-1, glow-wire test at 960 °C for external parts made of insulating material necessary to retain in position current-carrying parts and parts of protective circuit (650 °C for all other external parts made of insulating material)	
Mounting position	Vertical / Horizontal / Upside down / On the side	
Fixing	On symmetric rail EN/IEC 60715 or DIN 35	
Maximum cable size	Top/Bottom	1 x 1.5 mm ² to 50 mm ²
	Rigid cable	2 x 1.5 mm ² to 25 mm ²
	Top/Bottom	1 x 1.5 mm ² to 35 mm ²
	Flexible cable	2 x 1.5 mm ² to 20 mm ²
Applied connection torque	Recommended : 2.5 Nm Minimum : 2 Nm Maximum: 3 Nm	
Mechanical endurance	20000 operations without load	
Electrical endurance	10000 operations with load (under $I_n \cdot \cos \phi = 0.9$) 2000 operations under I_n , DC current	
Permissible ambient temperature	80 to 125 A - Maximum + 70 °C Minimum -25 °C	

Power dissipated in Watt per pole at I_n

Circuit breakers C and D curves

I_n (A)	0,5	1	1,6	2	3	4	5	6	7,5	10	16	20	25	32	40	50	63
1P ÷ 4P	1.7	2	2	2	2	2.1	1.1	1.4	1.8	2	2.2	2.7	3.2	4	4.5	5.5	

Permitted limit as per IEC 60898	3	3	3	3	3	3	3	3	3	3.5	4.5	4.5	6	7.5	9	13	
----------------------------------	---	---	---	---	---	---	---	---	---	-----	-----	-----	---	-----	---	----	--

 Impedance per pole (Ω) = $\frac{P \text{ dissipated}}{I_n^2}$

I_n (A)	Ambient Temperature / I_n									
	-25 °C	-10 °C	0 °C	10 °C	20 °C	30 °C	40 °C	50 °C	60 °C	70 °C
0,5	0.62	0.6	0.57	0.55	0.52	0.5	0.47	0.42	0.40	0.38
1	1.5	1.4	1.3	1.2	1.1	1	0.9	0.8	0.7	0.6
2	2.8	2.6	2.5	2.3	2.2	2	1.9	1.8	1.7	
3	3.8	3.6	3.5	3.3	3.2	3.0	2.9	2.8	2.7	2.6
4	4.5	4.2	4.0	3.9	3.7	3.5	3.4	3.3	3.2	3.1
5	6.4	6.0	5.8	5.5	5.3	5.0	4.8	4.7	4.5	4.6
6	7.5	7.0	6.6	6.4	6.2	6.0	5.8	5.6	5.4	5.3
10	12.5	11.5	11.1	10.7	10.3	10.0	9.7	9.3	9.0	8.7
16	20.0	18.7	18.0	17.3	16.6	16.0	15.4	14.7	14.1	13.5
20	25.0	23.2	22.4	21.6	20.8	20.0	19.2	18.4	17.6	16.8
25	31.5	29.5	28.3	27.2	26.0	25.0	24.0	22.7	21.7	20.7
32	41.0	37.8	36.5	34.9	33.3	32.0	30.7	29.1	27.8	26.5
40	51.0	48.0	46.0	44.0	42.0	40.0	38.0	36.0	34.0	32.0
50	64.0	60.0	57.5	55.0	52.5	50.0	47.5	45.0	42.5	40.0
63	80.6	75.6	72.5	69.9	66.1	63.0	59.8	56.1	52.9	49.7

Choice of DX³ MCBs for capacitor banks

This table shows the rated current of MCBs to be used when controlling capacitor banks so as to guarantee its function and shortcircuit protection.

Overload protection is not necessary since these installations cannot be overloaded.

This data refers to shortcircuit protection in absence of harmonics or heavy transitory currents.

Power of capacitor bank in kVAR	DX ³ MCB rating in amps			
	C characteristic		D characteristic	
	Single phase 240 V	Three phase 415 V	Single phase 240 V	Three phase 415 V
0,5	10	6	3	1
1	20	6	6	2
1,5	32	10	10	3
2,5	40	16	10	4
3	50	16	16	4
3,5	63	20	16	6
4	63	25	16	6
4,5	...	25	20	10
5	...	32	20	10
5,5	...	32	25	10
6	...	32	25	10
6,5	...	40	25	10
7	...	40	32	10
7,5	...	50	32	16
8	...	50	32	16
8,5	...	50	40	16
9	...	50	40	16
9,5	...	63	40	16
10	...	63	40	16
10,5	80	63	60	16
11	80	...	50	16
11,5	80	...	50	16
12	80	...	50	20
12,5	80	...	50	20
13	100	...	63	20
13,5	100	...	63	20
14	100	...	63	20
14,5	100	...	63	25
15	100	...	63	25
15,5	100	25
16	100	25
16,5	125	25
17	125	25
17,5	125	25
18	125	32
18,5	125	32
19	125	32
19,5	125	32
20	125	32
20,5	32
21	32
21,5	32
22	32
22,5	32
23	32
23,5	40
24	40
24,5	40
25	40
25,5	40
26	40
26,5	40
27	40
27,5	40
28	40
28,5	40
29	50
29,5	50
30	50
30,5	...	80	...	50
31	...	80	...	50
31,5	...	80	...	50
32	...	80	...	50
32,5	...	80	...	50
33	...	80	...	50
33,5	...	80	...	50
34	...	80	...	50
34,5	...	80	...	50
35	...	80	...	50
35,5	...	80	...	50
36	...	80	...	50
36,5	...	80	...	63
37	...	80	...	63
37,5	...	80	...	63
38	...	80	...	63
38,5	...	80	...	63
39	...	100	...	63
39,5	...	100	...	63
40	...	100	...	63
40,5	...	100	...	63
41	...	100	...	63
41,5	...	100	...	63
42	...	100	...	63
42,5	...	100	...	63
43	...	100	...	63
43,5	...	100	...	63
44	...	100	...	63
44,5	...	100	...	63
45	...	100	...	63
45,5 to 48	...	100
48,5 to 60	...	125

■ Technical data

Specification	SPEC/E-12/1/14
Number of poles	1
Characteristic	As applicable
Line terminal	Indicated by LN
Load terminal	Indicated by LD
Rated Voltage	130 V _~
Max. Operating Voltage	440 V _~
Min. Operating Voltage	12 V _~
Voltage resistance	> 2500 V _~
Enclosure	Moulded out of DMC (thermoset plastic) bone grey colour, flamability class V1-UL94, Tracking index - 600+volts
Dolly	Black, can be locked or lead sealed in ON or OFF position
Fire retardent grade of enclosure	V
Mounting position	Optional
Fixing	Snap fixing on standard DIN RAIL profile EN 50023 - 35 x 7.5
Terminals	With flat Cu terminal extension mounting as per skel 3700. Current Carring Capacity 100 Amp. Max. Continuous.
On-Off indication	MCB in on position when marking I-ON appears on dolly. MCB in OFF position when making O-Off appears on dolly.
Mech. Service Life	10000 operation
Electrical Endurance	6000 operation at rated load
Climate resistance :	25/95-40/93 (°C/RH)
Permissible Ambient :	T max. - 45 °C, T min - 25 °C temperature
Shock resistance	20 g minimum 20 impacts duration of shock 13 ms.
Vibration resistance	3 g

As per international STD, MCB in 'ON' condition when dolly is in upper position.

DX³

MCBs

Technical data

Correct polarity connections for DC MCBs

• Supply terminals

When supply is given at lower terminals

Single pole MCB

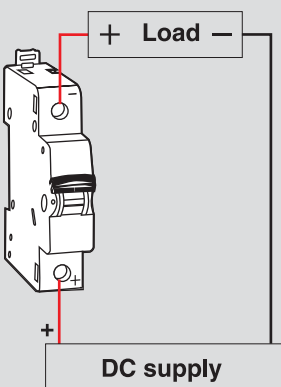

Double pole MCB

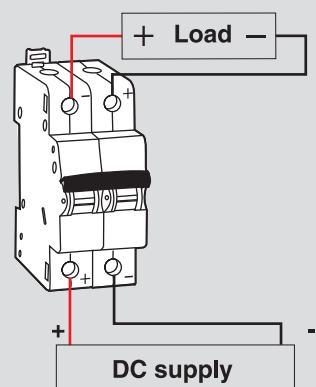

• Supply terminals

When supply is given at upper terminals

Single pole MCB

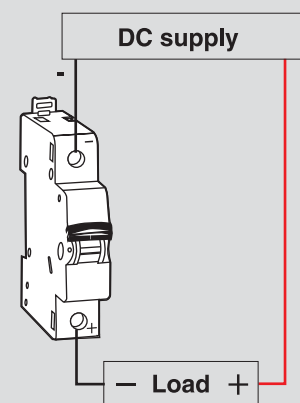

Double pole MCB

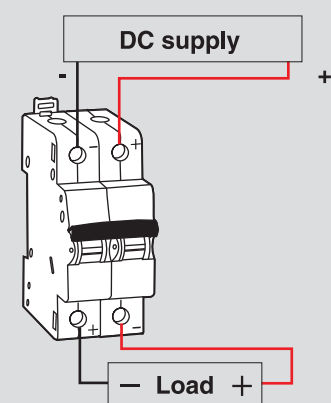

Derating of MCB for use with fluorescent lights

Ferromagnetic and electronic ballasts have a high inrush current for a short time. These currents can cause the tripping of circuit breakers. At the time of the installation, it should take into account the maximum number of ballasts per circuit breaker that the manufacturers of lamps and ballasts indicate in their catalogues.

Influence of the altitude

	≤2000 m	3000 m	4000 m	5000 m
Dielectric holding	3000 V	2500 V	2000 V	1500 V
Max operational voltage	400 V	400 V	400 V	400 V
Derating at 30 °C	none	none	none	none

Derating of MCBs function of the number of devices side by side:

When several MCBs are juxtaposed and operate simultaneously, the thermal evacuation of the poles is limited. This results in an increase in operating temperature of the circuit breakers which can cause unwanted tripping. It is recommended to apply the following coefficients to the rated currents.

Influence of the altitude

Number of circuit breakers side by side	Coefficient
2 - 3	0.9
4 - 5	0.8
6 - 9	0.7
≥10	0.6

These values are given by the recommendation of IEC 60439-1, NF C 63421 and EN 60439-1 standards.

Tripping characteristics

Standards has established different tripping characteristics depending on minimum and maximum values of magnetic trip.

DX ³ MCB	Type	Im1	Im2	Typical application
0.5 A to 63 A	D	10 In	20 In	Protection of cable and appliance which has very high starting currents.
6 A to 63 A	C	5 In	10 In	Protection of cable used for lighting load, power load and induction loads with high starting current.

Im1 - hold limit
Im2 - Trip limit

DX³ MCBs versus zero point extinguishing MCBs

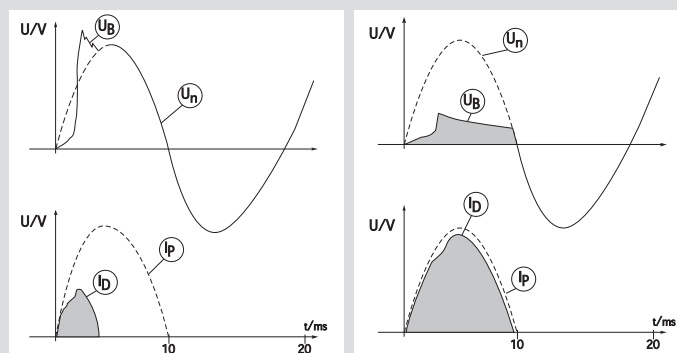

Current limiting DX³ MCB

Zero point extinguishing MCB

Un = Mains Voltage
UB = Arc Voltage
ID = Let-through short circuit current
IP = Prospective short circuit current

Technical data

Association of protection devices

Association is the technique by which the breaking capacity of a MCB is increased by coordinating it with another protection device, placed upstream. This coordination makes it possible to use a protection device with a breaking capacity which is lower than the maximum prospective short-circuit current at its installation point

The breaking capacity of a protection device must be at least equal to the maximum short-circuit which may occur at the point at which this device is installed.

In exceptional cases, the breaking capacity may be lower than the maximum prospective short-circuit, as long as:

- It is associated with a device upstream which has the necessary breaking capacity at its own installation point
- The downstream device and the trunking being protected can withstand the power limited by the association of the devices.

Association therefore leads to substantial savings.

The association values given in the tables on the following pages are based on laboratory tests carried out in accordance with IEC 60947-2.

Note: In the case of single phase circuits (protected by P+N or 2P MCBs) in a 415 V AC supply, supplied upstream by a 3-phase circuit, it is advisable to use the association tables for 230 V.

Example of association

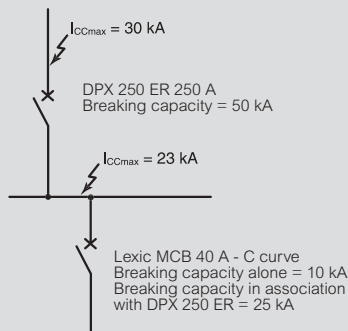

3-level association

An association may be created on three levels if one of the conditions below is met.

- The upstream device A must have an adequate breaking capacity at its installation point. Devices B and C are associated with device A. Simply check that the association values B+A and C+A have the necessary breaking capacity.

In this case, there is no need to check the association between devices B and C.

- The association is made between successive devices: Upstream device A, which has an adequate breaking capacity at its installation point, device C is associated with device B which is in turn associated with device A.

Simply check that the association values C+B and B+A have the necessary breaking capacity. In this case, there is no need to check the association between devices A and C.

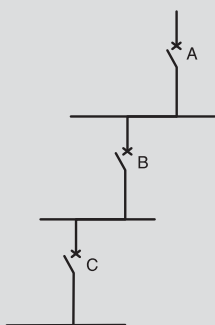

Association in IT connection systems

The values given in the tables should only be used for TN and TT systems.

Although this practice is not widely used, these values may also be used for installations with IT systems. It is therefore advisable to check that each protection device, on its own, can break, on a single pole, the maximum double fault current at the point in question.

Association between distribution boards

Association applies to devices installed in the same distribution board as well as in different boards. It is therefore generally possible to benefit from the advantages of the association between devices located, for example, in a main distribution board and in a secondary board.

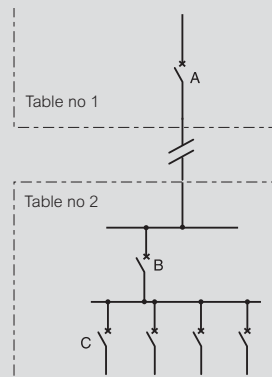

MCB - switch association

The switches must be systematically protected by an MCB placed upstream. There is considered to be protection against overloads if the rating of switch I is at least equal to that of the upstream MCB, D. If this is not the case, the thermal stresses (devices and conductors) must be checked. The tables on the following pages give the breaking capacity limits of the MCB - switch associations.

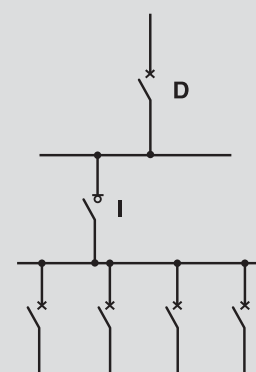

Discrimination of protection devices

Discrimination is a technique which consists of coordinating the protection in such a way that a fault on one circuit only trips the protection placed at the head of that circuit, thus avoiding rendering the remainder of the installation inoperative. Discrimination improves continuity of service and safety of the installation

Discrimination rules are set by the regulations concerning public buildings and for safety installations in general.

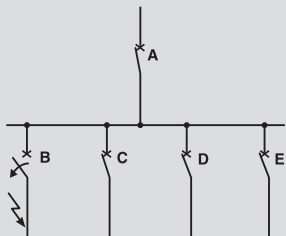

Discrimination between A and B is said to be "total" if it is provided up to the value of the maximum prospective short-circuit at the point at which B is installed.

By extension, in the tables on the following pages, total discrimination, indicated by T, means that there is discrimination up to the breaking capacity of device B.

Discrimination between A and B is said to be "partial" in the other cases.

The discrimination limit (given in the following tables) is therefore defined. This gives the short-circuit current value below which only MCB B will open and above which MCB A will also open.

There are a number of techniques for providing discrimination:

- Current discrimination, used for terminal circuits which have low short-circuits.
- Time discrimination, provided by a delay on tripping the upstream MCB
- Logical discrimination, a variant of time discrimination, used on electronic MCBs via a special link between the devices.

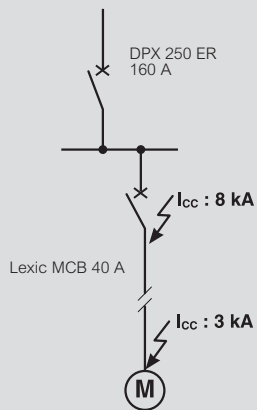

Since almost all faults occur during use, partial discrimination may be adequate if the discrimination limit is higher than the value of the maximum short-circuit which may occur at the point of use (or at the end of the trunking). This is referred to as "operating discrimination". This technique is very often adequate, more economical and less restricting in terms of implementation.

The discrimination limit for the association DPX 250 ER (160 A) with Lexic MCB 40 A (C curve) is 6 kA. Since the prospective ISC at the point of installation is 8 kA, the discrimination is not total. However, there is discrimination at the point of use at which the prospective short-circuit is only 3 kA.

Current discrimination

This technique is based on the offset of the intensity of the tripping curves of the upstream and downstream MCBs. It is checked by comparing these curves and checking that they do not overlap. It applies for the overload zone and the short-circuit zone, and the further apart the ratings of the devices, the better the discrimination.

- On overloads

To have discrimination in the overload zone, the ratio of the setting currents (I_r) must be at least 2.

- On short-circuits

To have discrimination in the short circuit zone, the ratio of the magnetic setting currents (I_m) must be at least 1.5.

The discrimination limit is then equal to the magnetic release current I_{mA} of the upstream MCB. The discrimination is then total as long as I_{SCB} is less than I_{mA} .

Current discrimination is therefore very suitable for terminal circuits where the short-circuits are relatively weak.

In other cases, time discrimination may be used together with current discrimination.

Current discrimination

The discrimination is total for I_{SCB}

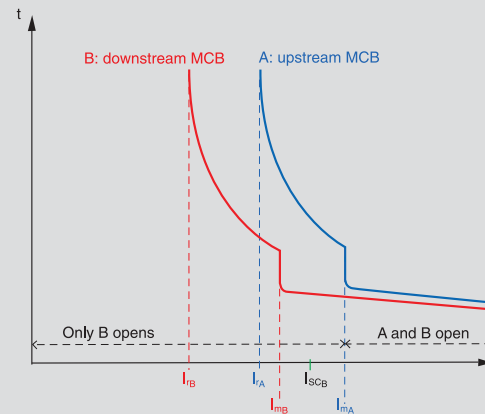

I_{SCB} : maximum short-circuit at the point at which MCB B is installed

When the downstream MCB B is a limiting device, the short-circuit current is limited in terms of time and amplitude. The discrimination is therefore total if the limited current I_{SCB} , which device B allows to pass, is lower than the tripping current of device A

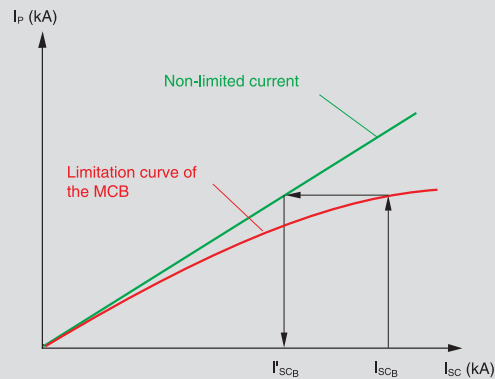

I_{SCB} : prospective short-circuit at the point at which the device is installed
 I'_{SCB} : short-circuit limited by device B

Time discrimination

This technique is based on the offset of the times of the tripping curves of the MCBs in series. It is checked by comparing the curves and is used for discrimination in the short-circuit zone. It is also used in addition to current discrimination in order to obtain discrimination beyond the magnetic setting current of the upstream MCB (I_{mA}).

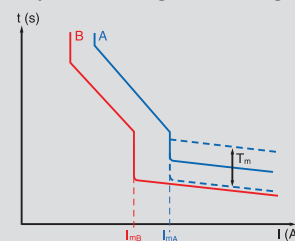

The following is necessary:

- It must be possible to set a time delay on the upstream MCB
- The upstream MCB must be able to withstand the short-circuit current and its effects for the whole period of the time delay
- The trunking through which this current passes must be able to withstand the thermal stresses (I^2t).

The non-tripping time of the upstream device must be longer than the breaking time (including any time delay) of the downstream device.

DPX MCBs have a number of time delay setting positions for creating discrimination with a number of stages.

DX³

MCBs

Selection chart*

DX³ MCBs (10 kA) and RCBOs 3 phase motor application

Motor H.P.	KW	MCB rating (A)	
		Star Delta	DOL
1	0.75	-	1.6 A
1.5	1.10	-	2 A
2	1.50	-	3 A
3	2.25	-	4 A
4	3.00	-	10 A
5	3.75	10 A	10 A
6	4.50	10 A	10 A
7.5	5.50	16 A	16 A
10	7.50	16 A	20 A
12.5	9.30	20 A	25 A
15	11.00	25 A	32 A
17.5	13.00	25 A	32 A
20	15.00	40 A	40 A
25	18.50	40 A	50 A
30	22.50	50 A	63 A
35	26.00	63 A	-

For MCB/RCBO ratings :

Single phase = $P = VI$

Three phase = $P = \sqrt{3} VI \cos \phi = 1.732 \times VI \times 0.8$

Note : One lighting circuit can have upto 800 W or upto 10 points.

One power circuit can have upto 3000 W or upto 2 power points.

* The data given above is only for guidance.

The exact rating must be selected only after considering the motor characteristics.

Technical data

Isolators

Specifications	IEC 60947-3	
Number of poles	DP, TP, FP	
Utilization category	AC22A	
Rated operational voltage and frequency	415 V, 50/60 Hz	
Insulation voltage Ui	500 V AC	
Impulse voltage Uimp	6 kV	
Short circuit making capacity Icm	1000 A	
Endurance	Electrical - 1500 operations with load AC22A Mechanical - 10000 operation	
Mounting position	Vertical / Horizontal / Upside down / On the side	
Fixing	On symmetric rail EN/IEC 60715 or DIN 35	
Maximum cable size	Top/Bottom	1 x 1.5 mm ² to 35 mm ²
	Rigid cable	2 x 1.5 mm ² to 16 mm ²
	Top/Bottom	1 x 1.5 mm ² to 25 mm ²
	Flexible cable	2 x 1.5 mm ² to 10 mm ²
Applied connection torque	Recommended : 3 Nm Minimum : 2 Nm Maximum: 3.5 Nm	
Permissible ambient temperature	Maximum + 70 °C Minimum -25 °C	

DX³ RCDS

Technical data for DX³ RCDs

	RCCB		
	Type AC	Type A-S	Type Hpi
Specification	IS 12640 (part 1) 2008 IEC 61008 - 1	IEC 61008 - 1 EN 61008 - 1	EN 61008 - 1 IEC 61008 - 1
No. of modules	- Double pole - Four pole	2 4	2 4
Electrical characteristics			
Nominal rating In (A)	- Double pole - Four pole	25, 40, 63, 80, 100 25, 40, 63, 80, 100	63, 80 25, 40, 63, 80
Rated sensitivity (mA)	- Double pole - Four pole	30, 100, 300 30, 100, 300	300 300
Rated frequency (Hz)		50 / 60	50 / 60
Rated operating voltage Ue (V AC)	- Double pole - Four pole	230 230 / 415	230 400
Minimum operating voltage (V AC)		12	12
Minimum operating voltage for test button (V AC)⁽¹⁾			
	- Double pole	170	170
	- Four pole	196	196
Rated insulation voltage Ui (V AC)	- Double pole - Four pole	250 500	250 500
Rated impulse withstand voltage Uimp (kV)		6	6
Breaking capacity	As per IS 12640 (part 1) 2008, IEC 61008 - 1		
Rated making & breaking capacity (Im)			
	- Up to 40 A	500 A	-
	- From 63 A and above	10 x In	630 A
Rated residual making & breaking capacity (IΔm)			
	- Up to 40 A	1000 A	-
	- From 63 A and above	1000 A	1000 A
Rated conditional short circuit current (Inc)		10000 A	10000 A
Rated conditional residual short circuit current (IΔc)		10000 A	10000 A
Rated service short circuit capacity (Ics)		-	-
Rated short circuit capacity (Icn)		-	-
Operating temperature (°C)		- 25 to 70	- 25 to 70
Endurance (0.C cycle)	- Mechanical - On load at in X cos φ 0.9 - Via test button - By fault current (sensitivity)	20,000 10,000 2,000 2,000	20,000 10,000 2,000 2,000
Testing	By pressing test button grey dolly will come to OFF position It is recommended to test RCCB once a month	By pressing test button grey dolly will come to OFF position It is recommended to test RCCB once a month	By pressing test button, grey dolly will come to OFF position It is recommended to test RCCB once a month
Fault indication	- Earth leakage	Grey dolly will come to OFF position	Grey dolly will come to OFF position
	- Overload and shortcut	-	-
Resetting		Switch on grey dolly	Switch on grey dolly
Terminals	- Rigid - Flexible	1 - 35 sq. mm 1 - 25 sq. mm	1 - 35 sq. mm 1 - 25 sq. mm
Type of protection			
Earth leakage		•	•
Overload		-	-
Short circuit		-	-
Add on electrical accessories*			
Auxiliary		•	•
Fault signaling		•	•
Shunt trip		•	•
Under voltage		•	•
Over voltage		•	•

* - Accessories are mounted on the left hand side of the product.
At a time a maximum of three accessories can be mounted.

⁽¹⁾ - Between phase and neutral

RCBO				
Type AC	Type AC - 2 & 4 modules	Type Hpi	Type A	
IS 12640 (part 2) 2008 IEC 61009 - 1	NFC 61 - 410 EN 61009 - 1 IEC 61009 - 1	EN 61009 - 1 IEC 61009 - 1	EN 61009 - 1 IEC 61009 - 1	
4	2	2	-	
7	4	-	4	
6, 10, 16, 25, 32, 40, 63	6, 10, 16, 20, 25, 32	25, 32, 40	25, 32, 40	
16, 25, 32, 40, 63	10, 16, 20, 25, 32	-	-	
30, 100, 300	30, 300	30	30, 300	
30, 100, 300	-	-	-	
50	50	50 / 60	50 / 60	
230	230	230	-	
415	415	-	415	
12	12	12	12	
170	170	170	-	
196	196	-	196	
500	250	250	-	
500	500	-	500	
4	6	6	6	
As per IS 12640 (part 2) 2008, IEC 61009 - 1				
10000 A	6000 A	6000 A	6000 A	
10000 A	-	-	-	
10000 A	3000 A	3000 A	3000 A	
10000 A	-	-	-	
-	-	-	-	
-	-	-	-	
7500 A	6000 A	6000 A	6000 A	
10000 A	6000 A	6000 A	6000 A	
- 25 to 70	- 25 to 70	- 25 to 70	- 25 to 70	
20,000	20,000	20,000	20,000	
10,000	10,000	10,000	10,000	
1,000	1,000	1,000	1,000	
1,000	1,000	1,000	1,000	
By pressing test button, black dolly will come to OFF position It is recommended to test RCBO once a month	By pressing test button, black dolly will come to OFF position It is recommended to test RCBO once a month	By pressing test button, black dolly will come to OFF position It is recommended to test RCBO once a month	By pressing test button, black dolly will come to OFF position It is recommended to test RCBO once a month	
Black & blue dolly will come to OFF position	Black dolly will come to OFF position & blue indicator will appear on front face window	Black dolly will come to OFF position & blue indicator will appear on front face window	Black dolly will come to OFF position & blue indicator will appear on front face window	
Black dolly will come to OFF position	Black dolly will come to OFF position	Black dolly will come to OFF position	Black dolly will come to OFF position	
Switch on black dolly	Switch on black dolly	Switch on black dolly	Switch on black dolly	
1 - 35 sq. mm	0.75 - 16 sq. mm	0.75 - 16 sq. mm	0.75 - 16 sq. mm	
1 - 25 sq. mm	0.75 - 10 sq. mm	0.75 - 10 sq. mm	0.75 - 10 sq. mm	
•	•	•	•	
•	•	•	•	
•	•	•	•	
•	•	•	•	
•	•	•	•	
•	•	•	•	
•	•	•	•	
•	•	•	•	



Technical data
Short-circuit withstanding capacity of RCCBs (in kA)



RCD downstream	DX ³ MCB upstream	
2P	16	10
	25	10
	40	10
	63	10
	80	10
	100	10
4P	25	10
	40	10
	63	10
	80	10
	80	10
	100	10

Marking example :

Type A 

Type AC 

Type A-S  

Type Hpi   

Technical data
Nature and consequences of electrical risks
Direct and indirect contact

All electrical risks for people are the result of direct or indirect contact. What are these contacts? And how can we protect ourselves against them?

All the answers appear in the following section.

Electrical risks do not just concern people : these risks - especially fire affect installations as well. A 500 mA current, for example, flowing through combustible material is sufficient to ignite such material after a certain time. Every electrical installation is subject to current leakages which can vary considerably depending on such factors as the installation's condition, age, environment, etc.

These current leaks may flow through the fabric of the building (trunking, metal girders or other metal components), generating heat which in turn may lead to fire.

Direct contacts

Direct contact is caused by humans and may be due to either carelessness or clumsiness.

What is a direct contact? How can we protect ourselves? Here are the answers...

This is when someone makes contact with a live electrical component of a device or installation.

For example :

- a person inadvertently touching a live cable.
- a child sticking a metal object into a power socket.
- using male/male extensions or unprotected test cables.

In this case only basic protection is effective

Other examples

Someone touching a live busbar in a distribution panel or cabinet, or someone touching flush-mounted electrical trunking with the end of a tool, etc. In this case basic protection plus additional protection is effective.

How can we protect ourselves?

There are two ways (independent of the neutral earthing system) of ensuring that personnel are protected against direct contact.

• Preventing access to live parts where possible.

Basic protection via physical or electrical isolation of live parts.

This protection must ensure that live parts cannot be touched, even inadvertently.

How?

By using barriers, enclosures, closed cabinets which physically or electrically isolate live parts presenting a danger to the user, shuttered sockets, or insulation.

• Additional protection

Must be provided by a 30-mA residual current device such as Lexic range of residual current devices. This protection is required in case the basic protection detailed above fails.

Technical data

Indirect contacts

Indirect contacts are independent of humans : it results from an internal hardware fault.

What is an indirect contact?

How can we protect ourselves? Here are the answers...

What is an indirect contact?

This is when a person makes contact with a metal earthed part which has accidentally been powered up following an insulation fault. This type of contact is very dangerous as, unlike direct contact, it is completely unexpected. For example, a person touching the metal frame of an electrical appliance which has defective insulation may be electrocuted through no fault of their own if the appliance is not protected.

How can we protect ourselves?

There are three possibilities :

- Preventing access to potentially dangerous metal components via class II protection.
- Good connection of all exposed conductive parts to an effective earth.
- A protective RCD according to the neutral earthing system.



A person is in danger of electrocution if the fault current raises the voltage of the accessible metal part above 50 V to earth.

Important note:

Under the Indian Electricity Rules [rules 61 (A), 71 (1) and 73 (1)], installation of an RCCB is mandatory in all installations of 5 KW and above, in all luminous tube signs and X-ray installations. The bureau of Indian standards recommends that RCCBs installed at construction sites, temporary installations, agriculture and horticulture premises, limit the residual current to 30 mA.

Residual current devices, selection and operation

The main function of a residual current device is to ensure that people are protected from any risk of electrocution. It can also ensure protection against risk of fire.

What is the nature of these risks ? What are the consequences ?

Here are the answers...

Risks of electrocution-

The dangerous effects of electricity depend on two factors-:

- the flowing time through the human body
- the current value

These two factors are independent and the importance of the risk varies in accordance with the level of each factor.

The dangerous current value through a human body depends on the touch voltage and touch resistance of the human body.

In practice, the current value is defined using a standard "safety" voltage of 50 V. This voltage takes into account the maximum current which can be withstood by a human being with a minimum internal electrical resistance in given conditions. It also takes into account the maximum permissible time for the current to pass through the body without dangerous physio-pathological effects.

50 V is considered as the safe limit of voltage for human body in dry condition.

How does an electrical current affect the human body?

When subject to a voltage, the human body reacts like any other receiver with a given internal resistance. An electrical current passes through the body with three serious risks :

- Locking of the muscles, or tetanisation : the muscles through which the current passes contract and remain contracted : if this includes the rib cage, breathing may be impeded.
- Action on the heart : the cardiac rhythm is completely disrupted (ventricular fibrillation).
- Thermal effects may cause varying levels of damage to body tissue, including severe burns in the case of very high currents.



Examples of electrocution by direct or indirect contact.

Technical data

Effect of current on human body

The standards define the following curves, which take into account the two parameters required to assess the risk :

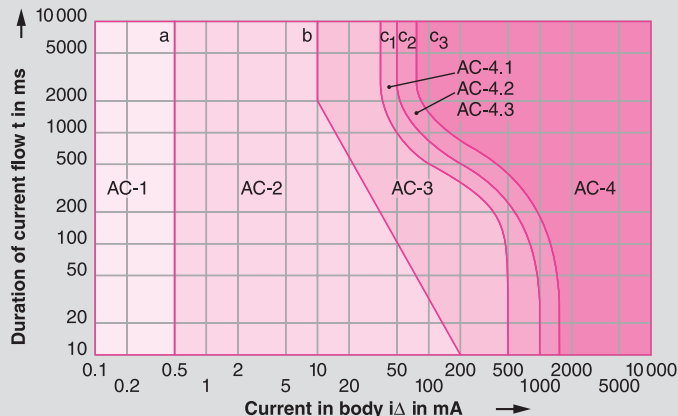

$i\Delta$: current flowing through body.
 t : time taken for current to pass through body.

These curves show the various zones of effect of an alternating current on people : they derive from IEC 60 479 and determine

4 main risk zones

Zone designation	Physiological effects
zone AC-1	Usually no reaction
zone AC-2	Usually no harmful physiological effects
zone AC-3	Usually no organic damage to be expected. Likelihood of cramp like muscular contractions and difficulty in breathing for durations of current-flow longer than 2 s. Reversible disturbances of formation and conduction of impulses in the heart, including atrial fibrillation and transient cardiac arrest without ventricular fibrillation increasing with current magnitude and time
zone AC-4	Increasing with magnitude and time, dangerous pathophysiological effects such as cardiac arrest, breathing arrest and serious burns may occur in addition to the effects of zone-3
zone AC-4.1	Probability of ventricular fibrillation increasing up to about 5% C1 - C2
zone AC-4.2	Probability of ventricular fibrillation up to about 50% C2 - C3
zone AC-4.3	Probability of ventricular fibrillation above 50%

* For durations of current flow below 10 ms, the limit for the body current at line b remains constant at a value of 200 mA.

A residual current device continuously measures the difference between the value of the input and the output currents. If the value is not equal to zero, this indicates a leak.

When this leak reaches the level at which the differential is set (its sensitivity), the device trips and breaks the circuit.

What are the operating principles of a residual current device?

What are the selection criteria for a residual current device? Here are the answers...

Operating principle of a residual current device

No fault present

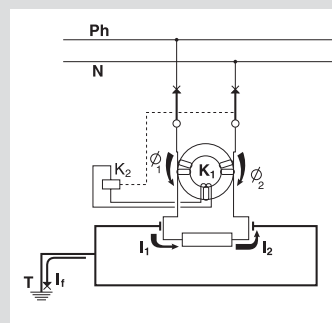

Therefore no current is induced in coil K₁, and coil K₂ is not excited. The contacts do not open. The equipment operates normally

$$I_1 = 0, \text{ thus}$$

$$I_1 = I_2$$

$$\Phi_1 = \Phi_2$$

$$\Phi_1 - \Phi_2 = 0$$

Insulation fault

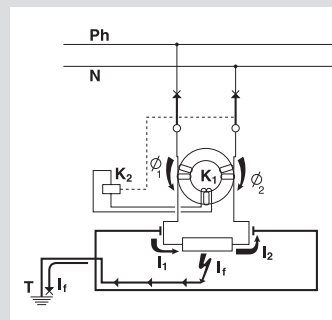

A current is thus induced in coil K₁...

$$I_1 \neq 0$$

$$I_1 > I_2, \text{ thus}$$

$$\Phi_1 > \Phi_2, \text{ thus}$$

$$\Phi_1 - \Phi_2 \neq 0$$

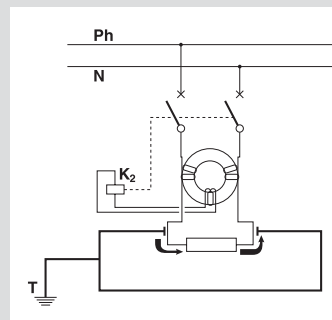

...coil K₂ is excited, the contacts open and the equipment is automatically switched OFF

Selecting a residual current device

First determine your requirement. This exists on two levels :

- 1 The need to protect against direct or indirect contacts.
- 2 The need to ensure protection against overloads and short-circuits.

If protection against indirect contact is required, use residual current devices with a sensitivity of :
 30 mA,
 100 mA,
 300 mA,

The rating (40, 63 A, etc.) is selected according to the load.

If protection against direct contact is required, use residual current device with a sensitivity of 30 mA.

The sensitivity of a residual current device $I\Delta n$ is the current level at which tripping is sure to occur. To do this, the standards concerning residual current devices stipulate that tripping must occur between $I\Delta n / 2$ and $I\Delta n$.

Technical data
Types of residual current device

There are 2 types of RCD : the AC type and the A type

Both types are produced in the "S" (discriminating) or normal versions. They conform to Indian and International standards IS 12640, IEC 61008 and IEC 61009 as well as European standards EN 61008 and EN 61009.

• Type A 

Sensitive to residual alternating currents and residual currents with a DC component.

Use : special applications

- if it is possible that the fault currents are not purely sinusoidal (rectifier bridge, etc.)

• Type AC 

Sensitive to residual alternating currents

Use : standard applications

• Type S 

Delayed trip for discrimination with other residual current devices.

Use : for discrimination with a downstream device.

• Type Hpi 

• Enhanced immunity to unwanted tripping in environments with disturbances. eg. diesels, computers, printers, etc.

• Detects faults with DC components eg. thyristors, trio etc.

Residual current circuit-breaker with or without overload protection? Which do I choose?

Choose a residual current circuit-breaker (RCCB) if you do not need to protect against overload and short circuits (caution! an RCCB must be connected to some form of line protection device : either a circuit-breaker or a fuse).

Choose a residual current circuit-breaker with overload and short circuit protection (RCBO) if this type of protection is not available.

Residual current circuit-breakers without overload and short circuit protection (RCCB)

These provide two functions : fault current detection, measurement and cut-off : and isolation of an installation.

RCCBs are governed by standards IS 12640 (part 1), IEC 61008-1.

Residual current circuit-breakers with overload and short circuit protection (RCBO)

These provide three functions : fault current detection, measurement and cut-off : protection against overloads and short-circuits : and isolation of an installation.

Residual current circuit-breakers are governed by standards IS 12640 (part 2), IEC 61009-1.

The "test" function

A residual current device is a safety device, and it is therefore vital that it is regularly tested. This function is therefore required by the standard governing residual current protective devices, and ensures correct operation. All Lexic RCDs are equipped with this function.

Note : We offer Type AC, Type A-S and Type Hpi RCDs

Compatibility MCBs/add-on modules

Breaking capacity	Number of poles	Add-on module for 1.5 module/pole MCBs
16 kA	2P, 4P	In ≥ 80 A
25 kA	4P	In ≥ 32 A
	2P	In ≥ 40 A
	4P	In ≥ 12,5 A
50 kA	2P	In ≥ 32 A
	2P, 4P	All range

Operating principle

Temporarily electrical disturbances and other external events can cause unwanted tripping of different devices protecting electrical installation

STOP&GO verifies automatically the state of the installation, before resetting and launches a visual and close a contact in case of permanent fault detection (short-circuit or residual current)

After verifying the state of the installation, STOP&GO automatic resets the associated protection device in order to immediatly re-establish power supply and avoid unwanted consequences

STOP&GO does not protect the installation against lightning strikes
For an efficient protection against lightning, use voltage surge protectors

The Autotest version is specially suitable for installations equipped with residual current protection devices (RCD's and RCBOs)
STOP&GO periodically does an automatic test of the functioning of residual current protection devices. The manual test is no longer needed



Installation without STOP&GO



Installation with STOP&GO

Mains fault due to temporarily electrical disturbances
Electrical devices are not powered anymore

STOP&GO automatic resets the associated protection device in order to immediatly re-establish power supply

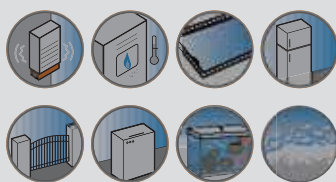

Technical characteristics of auxiliaries

Max. connection cross-section: 2.5 mm²
Operating temperature: - 25 °C to + 70 °C

Shunt trips

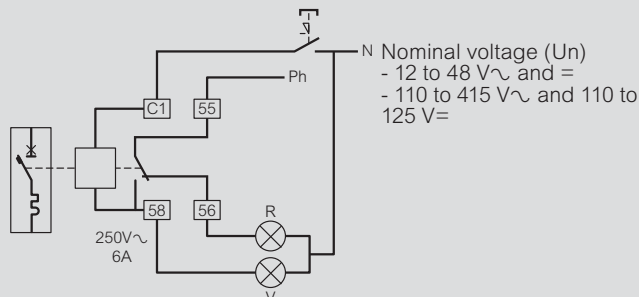

Equipped with a signalling contact which indicates tripping of the shunt trip and automatically breaks the coil.

Min. and max. voltage: 0.7 to 1.1 Un
Tripping time: less than 20 ms
Power consumption: at 1.1 x 48 V = 121 VA
at 1.1 x 415 V = 127 VA
Impedance: 12 to 48 V = 23 Ω
110 to 415 V = 1640 Ω

Consumption	Umin.	Umax.
12 to 48 V	522 mA	2610 mA
110 to 415 V	69 mA	259 mA

Undervoltage releases

Pull-in voltage $\geq 0.55 U_n$
Tripping time: 0 to 300 ms \pm 10% (adjustable)
Power consumption: 24 V \sim and = : 0.1 VA
48 V \sim and = : 0.2 VA
230 V \sim : 1 VA

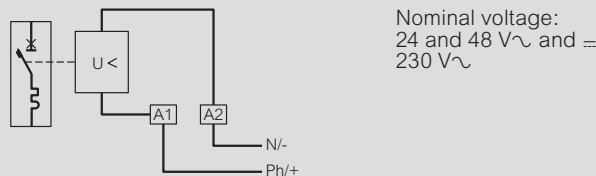

Stand-alone releases for N/C push-buttons

Min. and max. operating voltage: 196 to 250 V \sim
Power consumption: 1.4 VA

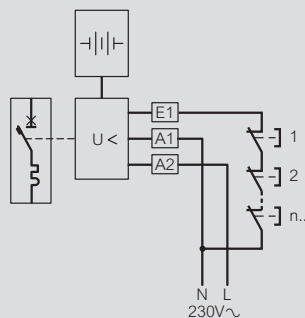

Signalling auxiliaries

Umin.: 24 V \sim / = and Imin.: 5 mA

Electric wiring diagram

Cat.No 4062 86

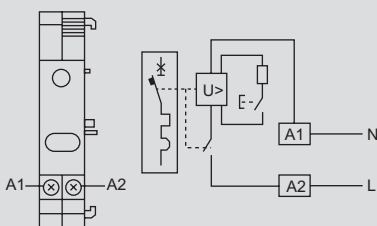

Tripping time:

Limit values of breaking time and non actuation time at a voltage

	255 V	275 V	300 V	350 V	400 V
Breaking time	No tripping	15 Sec	5 Sec	0.75 Sec	0.20 Sec
Non actuation time		3 Sec	1 Sec	0.25 Sec	0.07 Sec

Combinations with auxiliaries:

	CA / SD / ET / MT / DA	CM	
			4062 91/93/95
			4062 58/60/62/66
	4062 58/60/62/76/78/80/82/84/87	4062 58/60/62	4062 91
	4062 58/60/62/66/76/78/80/82/84/87	4062 66	
	4062 58/60/62	4062 58/60/62	4062 93/95
	4062 58/60/62/66	4062 66	

Protection of DC circuits

DX³ 6000 and DX³ 10000 MCBs (1P/2P/3P/4P - I_n ≤ 63 A) designed for use in 230/400 V~ supplies, can also be used in DC circuits. In this case, the following deratings and precautions must be taken into account:

1 - Protection against short-circuits

Max. magnetic tripping threshold: multiplied by 1.4

Example: For a C curve MCB for which the AC tripping threshold is between 5 and 10 I_n, the DC tripping threshold will be between 7 and 14 I_n

2 - Protection against overloads

The time/current thermal tripping curve is the same as for AC

3 - Operating voltage

Max. operating voltage: 80 V per pole (60 V for single-pole + N MCBs). For voltages higher than this value, several poles must be wired in series.

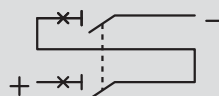

Example: for a 110 V voltage, use a 2-pole MCB and connect the 2 poles in series

4 - Breaking capacity

4000 A for a single pole MCB at max. voltage (80 V~ per pole)

For other voltages, the breaking capacities are as follows:

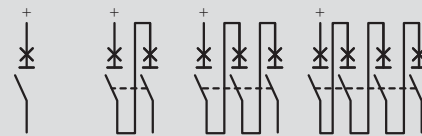

DX ³ 6000	voltage	single-pole	2P	3P	4P	
Acc. to IEC 60947.2	Icu	≤ 48 V	6 kA	6 kA		
		110 V		6 kA	6 kA	
		230 V				10 kA
	Ics ⁽¹⁾	≤ 48 V	100 %	100 %		
		110 V		100 %	100 %	
		230 V				100 %

DX ³ 10000	voltage	single-pole	2P	3P	4P	
Acc. to IEC 60947.2	Icu	≤ 48 V	10 kA	10 kA		
		110 V		10 kA	10 kA	
		230 V				15 kA
	Ics ⁽¹⁾	≤ 48 V	100 %	100 %		
		110 V		100 %	100 %	
		230 V				100 %

1: As a % of Icu

5 - Distribution of breaking poles

To choose the MCB and determine the pole distribution necessary for breaking on each of the polarities, it is necessary to know how the installation is earthed.

• Supply with one polarity earthed:

Place all the poles necessary for breaking on the other polarity. If isolation is required, an additional pole must be added on the earthed polarity.

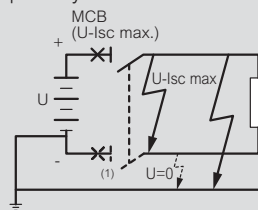

1: Only if isolation required

Protection of DC circuits

Protection of DC circuits

Example: circuit earthed via the negative polarity / $U = 110\text{ V}_{\text{DC}}$ / $I_{\text{sc}} = 10\text{ kA}$ / $I_n = 32\text{ A}$

Protect the positive polarity using an MCB capable of breaking 10 kA at 110 V (DX³ 10000 2P 32 A with 2 poles on the positive polarity)

For isolation, use a DX³ 10000 3P 32 A with 2 poles on the positive polarity and one pole on the negative polarity

DX ³ 10000	voltage	single-pole	2P	3P	4P
Acc. to	$\leq 48\text{ V}$	10 kA	10 kA		
IEC 60947.2 Icu	110 V		10 kA	10 kA	
	230 V				15 kA

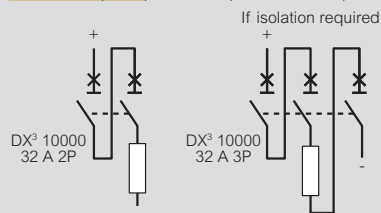

• Network earthed via a middle point:

Place on each polarity the number of poles necessary for max. I_{sc} breaking at half voltage

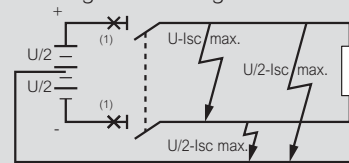

1: MCB ($U/2-I_{\text{sc}} \text{ max.}$)

Example: circuit earthed via a middle point / $U = 230\text{ V}_{\text{DC}}$ / $I_{\text{sc}} = 6\text{ kA}$ / $I_n = 10\text{ A}$

Protect each polarity using an MCB capable of breaking 6 kA at half voltage, i.e. 115 V

DX ³ 6000	voltage	single-pole	2P	3P	4P
Acc. to	$\leq 48\text{ V}$	6 kA	6 kA		
IEC 60947.2 Icu	110 V		6 kA	6 kA	
	230 V				10 kA

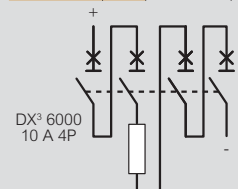

• Isolated earth supply:

Distribute the poles necessary for breaking over the 2 polarities to provide protection in the event of a double earth fault (particularly if there are a number of circuits in parallel)

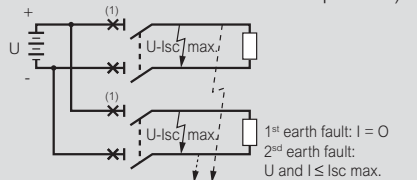

1: MCB ($U-I_{\text{sc}} \text{ max.}$)

Example: isolated earth circuit / $U = 48\text{ V}_{\text{DC}}$ / $I_{\text{sc}} = 4,5\text{ kA}$ / $I_n = 40\text{ A}$
Protect the installation with an MCB capable of breaking 4.5 kA at 48 V and protect each polarity

DX ³ 6000	voltage	single-pole	2P	3P	4P
Acc. to	$\leq 48\text{ V}$	6 kA	6 kA		
IEC 60947.2 Icu	110 V		6 kA	6 kA	
	230 V				10 kA

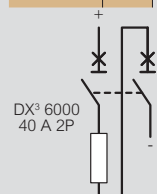

Programmable time switches

with analogue and digital dial

Diagrams

Cat.No 4126 31

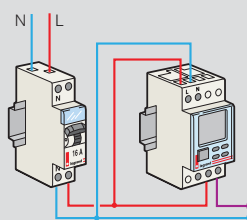

Cat.Nos 4126 54/34/29

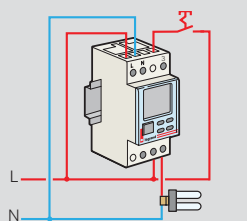

Cat.Nos 4126 57/41/30

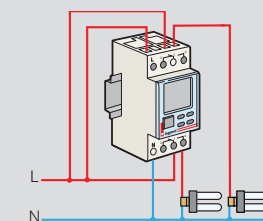

Cat.Nos 4127 90/94

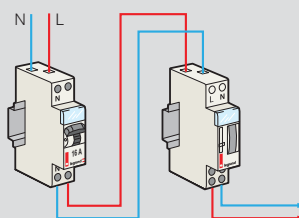

Cat.Nos 4128 12/13/14

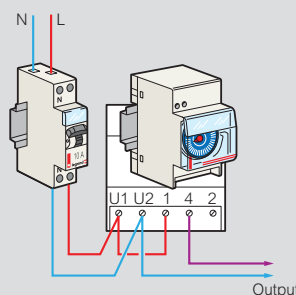

Output closing and breaking times are calculated based on the date, the actual time when the device was switched and on geographical coordinates of the actual location

AlphaRex³ digital time switches

Technical specifications

Type	AlphaRex ³ D21	AlphaRex ³ D22	AlphaRex ³ D21s	AlphaRex ³ D21 astro	AlphaRex ³ D22 astro	AlphaRex ³ DY21	AlphaRex ³ DY22
Nominal voltage 230 V 50/60 Hz	4126 31	4126 41	4126 34	4126 54	4126 57	4126 29	4126 30
Number of modules of 17.5 mm each	2	2	2	2	2	2	2
Number of channels	1	2	1	1	2	1	2
Switch output	1 changeover contact	2 changeover contacts	1 changeover contact	1 changeover contact	2 changeover contacts	1 changeover contact	2 changeover contacts
Zero-crossing switching	✓	✓	✓	✓	✓	✓	✓
Switching capacity							
• Ohmic 250 V \sim $\cos \phi = 1$	16 A \sim	16 A \sim	16 A \sim	16 A \sim	16 A \sim	16 A \sim	16 A \sim
• Inductive 230 V \sim $\cos \phi = 0.6$	10 A \sim	10 A \sim	10 A \sim	10 A \sim	10 A \sim	10 A \sim	10 A \sim
• Incandescent lamp load	2000 W	2000 W	2000 W	2000 W	2000 W	2000 W	2000 W
• Fluorescent lamp, series compensated	2000 VA	2000 VA	2000 VA	2000 VA	2000 VA	2000 VA	2000 VA
• Energy-saving lamp	1000 W	1000 W	1000 W	1000 W	1000 W	1000 W	1000 W
Programs ¹⁾	56	28 per channel	56	56	28 per channel	84	84 per channel
Control input with switch-off delay 0 s to 23 h 59 min 59 s			✓	✓		✓	
Cycle function (pulse time) min. 1 s, max. 1 h 59 min 59 s	✓	✓	✓	✓	✓	✓	✓
Clock precision (typical)					~ 0.1 s/day ²⁾		
Running reserve					5 years		
Shortest switching step					1 s		
Operating temperature					-20 to +55 °C		
Degree of protection					IP20		

¹⁾ A program consists of a switch-on time, a switch-off time as well as days or day blocks which are assigned as "switched-on" or "switched-off"

²⁾ Can be set to mains-synchronous operation

Connection diagram

AlphaRex³ D21

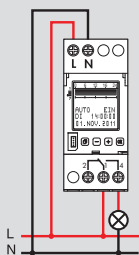

AlphaRex³ D22
AlphaRex³ D22 astro
AlphaRex³ DY22

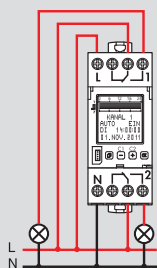

AlphaRex³ D21s
AlphaRex³ D21 astro
AlphaRex³ DY21

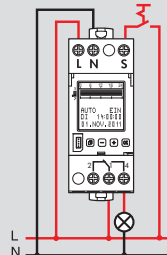

Functions

- Select menu, go back while in menu
Press > 1 sec. = operating display
- Confirm the selection or accept the parameter
- Select the menu item or set the parameter;
for 2-channel time switches, can be used
to select the channel (channel 1 – channel 2)
-

Brief description of programming functions

Text guidance

Guides the user through programming and setup with plain text prompts. Each step can be read on the screen, and the function that is currently active flashes. An integrated display and button light makes operation easy even in poorly lit environments.

Set language

The language selection function can be accessed using the "MENU" button. The language is set to English by default. The following languages can be selected: German, English, French, Italian, Spanish, Dutch, Portuguese*, Swedish*, Norwegian*, Finnish*, Danish*, Polish*, Czech*, Russian*, Turkish*.

* Excluding AstroRex DY64

Time, date, summer time (daylight saving time)

The time switch is preset at the factory to the current time and date. The time can be changed by selecting "MENU" + "SET".

Reset

Simultaneously pressing all buttons for more than 2 seconds deletes all data. Language, date/time, summer time (daylight saving time) and switch times must be set again.

Data key

If the supply voltage is switched on, the "KEY – READ – WRITE" menu item is automatically opened when a data key is inserted. "WRITE": Program data is written from the time switch to the key. Caution: Any data present on the key will be overwritten. "READ": Program data is written from the key to the time switch; any switching programs on the time switch are overwritten. Only one master switching program, which consists of multiple switching programs, can be saved on the time switch or on the key at a time. If the supply voltage is not connected, the "KEY – READ – WRITE" menu item is not automatically opened when a data key is inserted. The "KEY" function can still be selected from the menu even if the supply voltage is not connected.

PC programming

In addition to the easy, text-guided programming directly on the time switch, switching programs can also be created on a PC with the software program from Legrand and transferred to the time switch using a data key. A data transfer device (Cat.No : 4128 73) is required to transfer switching programs created on a PC to the data key. The device is connected to the PC using the USB plug. In addition to the data transfer device, we also offer a CD with the software and the necessary drivers. PC system requirements: USB port; Windows[®] XP, Windows[®] Vista, Windows[®] 7; approx. 40 MB of free memory.

Brief description of programming functions

Weekly programs

To create a weekly program, select "MENU", "PROGRAM", and then "CREATE" to easily enter programs which are repeated on a weekly basis. A weekly program consists of a switch-on/switch-off times and days which are assigned as "switched-on" or "switched-off". The following predefined blocks can be selected: "MONDAY – SUNDAY", "MONDAY – FRIDAY"¹⁾ or "SATURDAY – SUNDAY"¹⁾; the assigned days of the week are fixed. The switch-on/switch-off times must be entered. The user can also set custom day blocks. By selecting "CUSTOM", switch times can be freely assigned to any days of the week. This option also allows the user to set switch times at midnight.

¹⁾Excluding AlphaRex³ DY, AstroRex DY64

Yearly programs [AlphaRex³ DY21, AlphaRex³ DY22]

This menu item allows the user to enter (additional) yearly programs, which are only executed within a defined validity period. They can overlap with one another and with the weekly programs on the same channel based on an "OR" connective. The validity period is defined by entering the start date (at 00:00:00) and the end date (at 24:00:00). The start date must be entered before the end date. With the "EVERY YEAR" option, the additional switch times have the same validity period each year (Christmas, national holidays, birthdays, etc.) Select the "ONCE" option when additional switch times are needed within a validity period (e.g. during holidays), but the start/end dates of the holiday period change from year to year.

Special programs (priority program) [AlphaRex³ DY21, AlphaRex³ DY22]

Weekly and yearly programs on the same channel are not executed during the validity period of a special program. However, other special programs can be executed during the validity period. Different special programs can overlap with each other based on an "OR" connective. With the "EVERY YEAR" option, the additional switch times have the same validity period each year (Christmas, national holidays, birthdays, etc.). Select the "ONCE" option when additional switch times are needed within a validity period (e.g. during holidays), but the start/end dates of the holiday period change from year to year. Additional options include "MON TO SUN"/"CUSTOM": the respective channel only switches according to the special program; "PROG ON"/"PROG OFF": the respective channel is switched on/off during this time period.

Basic functions for "astro"

Location (astro) [AlphaRex³ D21 astro, AlphaRex³ D22 astro, AlphaRex³ DY21, AlphaRex³ DY22]

The sunrise/sunset times, which change daily, are calculated for the location programmed in the AlphaRex. The unit is delivered with the location set to "GERMANY – SOEST" by default. Enter the actual location for optimal operation. This can be done in two ways. Select "MENU", "SET" and "ASTRO" to access the two options "LOCATION" and "COORDINATES". "LOCATION": With this menu item, the user can select the country and city which is closest to the site of operation. "COORDINATES": Alternatively, the user can select this menu item to set the geographical coordinates of the location. The longitude and latitude values are entered in degrees or degrees and arcminutes²⁾ (precision can be set in expert mode). Information on coordinates and time zones can be found in the time zone map included with every time switch.

Offset

By selecting "MENU", "SET", "ASTRO" and "OFFSET", time differentials can be set for the calculated switch times. This can be done in two ways: time offset or angle offset.

In time offset, a time differential can be entered to shift the switch time by up to +/- 120 min relative to the sunrise/sunset times.

In angle offset²⁾, a value can be entered in degrees and arcminutes to shift the switch time by up to +/- 12° 00' relative to the sunrise/sunset times. The time differentials are set separately for sunrise and sunset using the menu items "SUNSET" (opens the screen for setting the sunset offset) and "SUNRISE" (opens the screen for setting the sunrise offset).

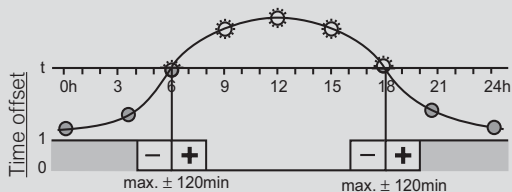

Example:

For a time differential of +30 min, the time switch switches 30 min. after sunrise and 30 min. after sunset.

For a time differential of -30 min, the time switch switches 30 min. before sunrise and 30 min. before sunset.

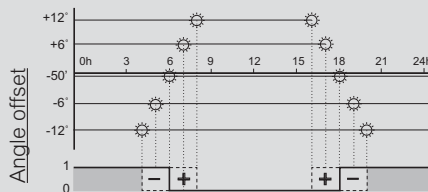

Note:

If the offset is set in degrees, the time switch always switches at points when the brightness is the same, despite the fact that the twilight duration changes over the course of the year. Sunrise and sunset correspond to -50' for the centre of the sun (the edge of the sun is visible on the horizon).

Offset correction function²⁾

Select "MENU", "SET", "ASTRO" and "CORRECTION" to set a time correction for the 6-month periods surrounding summer and winter. The time correction is set to 0 min. by default and can be set from 1 min. up to 30 min. The time correction for sunset is entered in the "SUNSET" menu item. The time correction for sunrise is set in the "SUNRISE" menu item. The correction function overlaps with the calculated astronomical switch times, including the offset settings.

Example:

Setting a time correction extends the daily switched-on time by up to 60 min. in the middle of the six winter months (switches off up to 30 min. later in the morning and switches on up to 30 min. earlier in the evening). In the middle of the six summer months, the time correction reduces the daily switched-on time by up to 60 min. (switches off up to 30 min. earlier in the morning and switches on up to 30 min. later in the evening). The time correction varies continuously between the two max. values during the rest of the year.

Basic settings using a PC and day key

All of the basic settings described above, with the exception of the current time and date, can be set up using the AlphaSoft software from Legrand and imported to the time switch using the data key.²⁾ Excluding AstroRex DY64

AlphaRex³ digital time switches

Additional functions

Relay function

The relay state can be changed by selecting "MENU" and "FUNCTIONS". The relay is preset to the "AUTO" function; the time switch switches at the programmed times. The following can also be selected: "ALWAYS ON", "ALWAYS OFF" and "EXTRA". If "EXTRA" is selected, the switching status specified by the program is inverted. The time switch resumes switching according to the programmed switch times after the next switch command.

Holiday program

In holiday program, the holiday period is set with a start and an end date. It can be activated with the "ACTIVE" program item and deactivated with "PASSIVE". If the holiday program is activated, the time switch does not carry out any programmed switch commands during this time period. Instead, it remains "ALWAYS OFF" or "ALWAYS ON" during the holiday period, as requested. When the holiday period has ended, the time switch resumes switching according to the programmed switch times.

1 h test

The "1 h TEST" function can be used for a switching simulation. If "1 h TEST" is activated, the switch outputs are switched for one hour. After the time has ended, the time switch resumes switching according to the programmed switch times.

PIN code

Input and programming can be locked using a four-digit "PIN CODE". The time switch can be unlocked using the "PIN CODE". The time switch can also be unlocked using the "RESET" function, which also deletes all settings and programs.

Operating hours counter

This function displays the time for which the relay has been switched on and the date of the last reset. Counting range: 65,535 h.

Contrast adjustment

This function allows the user to adjust the display contrast.

Expert mode*

Expert mode is activated by selecting "OPTIONS" and "EXPERT". After expert mode is activated, the following additional functions can be used: control input "extra"¹⁾, control input "out"¹⁾, cycle function, channel-switching function (2-channel time switches), mains-synchronous operation, offset correction function²⁾, geographical coordinates in degrees and arcminutes²⁾.

¹⁾ AlphaRex³ D21s, AlphaRex³ D21 astro, AlphaRex³ DY21 ²⁾ AlphaRex³ astro, AlphaRex³ DY

Control input with switch-off delay

Adjustable switch-off delay via control input. The control input enables an additional switching of the relay, parallel to the switching program. The switch-off delay can be set from 0 s to 23 h 59 min 59 s. The switch-off delay begins as soon as the voltage is removed from the control input.

Control input "extra"*

Override of switching state via control input. If the "EXTRA" function is activated, the switching state specified by the program is inverted. The time switch resumes switching according to the programmed switch times after the next switch command. The "EXTRA" function is ended prematurely if the button is pressed again or if a pulse is received at the control input.

Control input "off"*

Switch off via control input. Activating the "OFF" function causes the time switch to be switched off via the control input. The "OFF" function is ended if the button is pressed again or if a pulse is received at the control input. The time switch resumes switching on/off according to the programmed switch times.

Pulse function

Programmable with precision to the second.

Cycle function

Function for cyclical switching. With this function, the time switch is switched on once within a defined time period and for a defined duration. The cycle time can be set between 2 s and 2 h. The switch-on time can be set between 1 s and 1 h 59 min 59 s.

	Min.	Max.
Cycle	2 s	2 h
Switch-on time	1 s	1 h 59 min 59 s

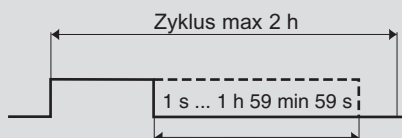

Random function

If the random function is activated, set switch times are randomly shifted within a range of +/- 15 minutes.

Channel-switching function*

With 2-channel time switches, this function can be activated so that the time switch regularly switches between the outputs assigned to the channels, in order to protect connected devices (for example lights/lamps) or so that two devices can be used simultaneously.

The channel-switching function is activated by selecting "MENU", "OPTIONS" and "CHANNEL 1<>2". The time switch switches between the outputs according to whether the menu item "DAILY" (once per day at 12:00 p.m.) or "WEEKLY" (once per week on Sunday at 12:00 p.m.) is selected.

Mains-synchronous operation

Mains-synchronised clock precision. By activating the "SYNC" function and then "ACTIVE", the quartz-controlled time switch becomes a synchronous time switch.

*) Excluding AstroRex DY64

Technical specifications

Type	MicroRex T31	MicroRex QT31	MicroRex W31	MicroRex QT11	MicroRex QW11
Number of modules of 17.5 mm each	3	1			
Number of channels	1	1	1	1	1
Drive type	synchronous	quartz	synchronous	quartz	quartz
Switching dial	24 h	24 h	7 days	24 h	7 days
Running reserve	none	100 h	none	100 h	100 h
Switching increment	15 min	15 min	2 h	15 min	2 h
Shortest switching step	30 min	30 min	4 h	15 min	2 h
Switching step	+/- 5 min	+/- 5 min	+/- 30 min	+/- 5 min	+/- 30 min
Clock precision	mains	2.5 s/day	mains	2.5 s/day	2.5 s/day
Switching capacity					
• Ohmic 230 V~ cos φ = 1	16 A~				
• Incandescent lamp 230 V~	4 A~				
• Inductive 230 V~ cos φ = 0.6	12 A~				
Switch output	1 changeover contact	1 changeover contact	1 changeover contact	1 normally open contact	1 normally open contact
Operating temperature	-10 to +55 °C				
Degree of protection	IP20				

Connection diagram

MicroRex – 3 modules

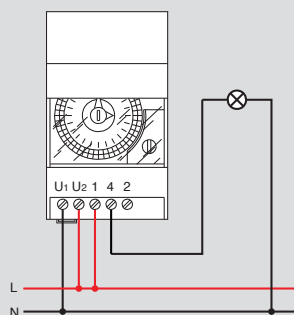

MicroRex – 1 module

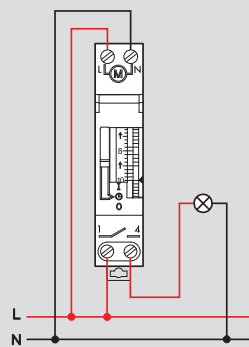

Wall bracket – 3 modules

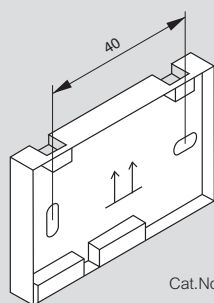

Cat.No 4128 59

3-module MicroRex units can be surface mounted using the wall bracket. A terminal cover is included with delivery.

Standard light sensitive switch (Cat.No 4126 23)

Switch "ON" and "OFF" defined by a light level threshold

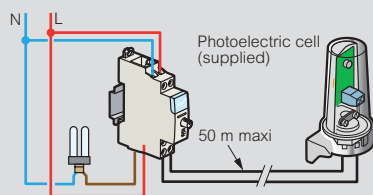

CX³ Changeover switches

Power dissipation per role : 1.5 w
 Overvoltage category : 4 kV~
 Dielectric withstand : 2 kV~
 Degree of pollution : 2

CX³ Push-buttons and control switches

Electrical endurance : 30.000 cycles AC12
 (cos φ = 0.9) IEC 60947-5-1
 Electrical endurance under fluorescent loads : 30 000 cycles according to IEC 60669-1

CX³ LED indicators

Equipped with non replaceable LED lamps
 LED life : 100 000 h.
 LED consumption :
 - 0.17 W under 230 V~
 - 0.11 W under 24 V~

Power contactors CX³

Technical characteristics

- Rated impulse withstand voltage (Uimp): 4 kV
- Mechanical endurance (no. of operating cycles): 10⁶ cycles
- Operating temperatures: - 25 °C to + 40 °C
- Storage temperatures: - 40 °C to + 70 °C

Contactor protection against short circuits according to standard EN 61095, conditional short-circuit current:

- I_q = 6 kA for 16 to 25 A contactors

- I_q = 3 kA for 40 to 63 A contactors

Circuit breaker or gG fuse rated:

- ≤ 16 A for 16 A rating • ≤ 40 A for 40 A rating
- ≤ 25 A for 25 A rating • ≤ 63 A for 63 A rating

Consumption of a contactor control coil

16 A and 25 A power contactors					
Coil voltage	24 V~		230 V~ low noise	230 V~	
Current	16 A and 25 A	25 A	25 A	16 A and 25 A	16 A and 25 A
Type of contact	NC + NO 2 NO	4 NO	2 NO	NC + NO 2 NO 2 NC	2 NC + 2 NO 4 NO 4 NC
Dimensions	1 mod.	2 mod.	1 mod.	1 mod.	2 mod.
Holding current	200 mA	300 mA	12 mA	20 mA	20 mA
Inrush current	970 mA	2500 mA	60 mA	90 mA	200 mA

40 A and 63 A power contactors				
Coil voltage	24 V~		230 V~	
Current	40 A and 63 A	40 A and 63 A	40 A and 63 A	40 A and 63 A
Type of contact	2 NO	4 NO	2 NO 2 NC	3 NO 4 NO 4 NC
Dimensions	2 mod.	3 mod.	2 mod.	3 mod.
Holding current	250 mA	270 mA	15 mA	30 mA
Inrush current	1750 mA	1500 mA	150 mA	200 mA

Recommendations

Insert a spacing module (Cat.No 4063 07 p. 40):

- every two contactors when the ambient temperature is below 40 °C

- every contactor when the ambient temperature is between 40 and 60 °C

Contactor rating	40 °C	50 °C	60 °C
le = 16 A	16 A	14 A	12 A
le = 25 A	25 A	22 A	20 A
le = 40 A	40 A	36 A	32 A
le = 63 A	63 A	57 A	50 A

Max. connection cross-section in mm²

Conductor type	Ratings ≤ 25 A	Ratings 40 & 63 A
Rigid	6 ² or 2 x 2.5 ²	25 ² or 2 x 10 ²
Flexible	6 ² or 2 x 2.5 ²	25 ² or 2 x 10 ²
Flexible with single end cap	6 ²	16 ²
Flexible with double end cap	2 x 4 ²	2 x 16 ²

Contactor selection charts

Incandescent lamps

Tungsten and halogen filaments 230 V~								
Nominal wattage	40 W	60 W	75 W	100 W	150 W	200 W	500 W	1000 W
16 A	45	30	24	19	13	10	4	2
25 A	60	48	38	30	20	15	6	3
40 A	96	77	61	48	32	24	10	5
63 A	154	123	97	77	51	38	15	8

ELV halogen bulbs with ferromagnetic ballast						ELV halogen bulbs with electronic ballast						
Nominal wattage	20 W	35 W	50 W	75 W	100 W	150 W	20 W	35 W	50 W	75 W	100 W	150 W
16 A	32	20	15	12	9	6	60	40	28	18	14	9
25 A	52	30	24	16	12	8	80	50	40	26	20	13
40 A	68	39	31	21	16	10	112	70	56	36	28	18
63 A	88	51	41	27	20	14	157	98	78	51	39	25

Contactor selection charts (continued)

Fluorescent tubes with ferromagnetic ballast

Nominal wattage	Single parallel compensated fluorescent					Double series compensated fluorescent				
	18 W	20 W	36 W	58 W	115 W	2 x 20 W	2 x 36 W	2 x 40 W	2 x 58 W	2 x 140 W
16 A	24	24	16	11	5	30	24	22	15	6
25 A	33	30	25	17	9	45	38	35	24	10
40 A	43	39	33	22	12	68	57	53	36	15
63 A	56	51	42	29	15	101	86	79	54	23

Nominal wattage	Quadruple series compensated fluorescent		Compact fluorescent with built-in starter			
	4 x 18 W		7 W	10 W	18 W	26 W
16 A	16		50	40	28	19
25 A	24		60	50	42	28
40 A	36		78	65	55	36
63 A	54		101	85	71	47

Fluorescent tubes with electronic ballast

Nominal wattage	Single fluorescent				Double fluorescent		
	18 W	30 W	36 W	58 W	2 x 18 W	2 x 36 W	2 x 58 W
16 A	72	42	36	22	36	20	12
25 A	110	68	58	36	56	30	19
40 A	165	102	87	54	84	45	29
63 A	248	153	131	81	126	68	43

Nominal wattage	Triple fluorescent (series compensated)		Quadruple fluorescent (series compensated)	
	3 x 14 W	3 x 18 W	4 x 14 W	4 x 18 W
16 A	34	26	26	20
25 A	46	38	37	28
40 A	62	51	52	39
63 A	84	69	73	55

Compact fluorescent with built-in electronic power supply					
Nominal wattage	7 W	11 W	15 W	20 W	23 W
16 A	120	80	64	50	43
25 A	200	125	90	70	60
40 A	280	175	126	98	84
63 A	392	245	176	137	118

Discharge lamps with compensation

Nominal wattage	Metal halogenide						Low pressure sodium vapour					
	35 W	70 W	100 W	150 W	250 W	400 W	18 W	35 W	55 W	90 W	135 W	180 W
16 A	10	6	5	3	2	1	12	6	5	3	2	2
25 A	15	9	7	5	3	2	20	10	7	5	3	3
40 A	23	14	11	8	5	3	30	15	11	8	5	5
63 A	34	20	16	11	7	5	45	23	16	11	7	7

Nominal wattage	High pressure sodium vapour					High pressure mercury vapour				
	70 W	150 W	250 W	400 W	1000 W	50 W	80 W	125 W	250 W	400 W
16 A	8	7	5	3	1	11	8	6	3	2
25 A	10	9	6	4	2	15	10	8	4	3
40 A	15	14	9	6	3	21	14	11	6	4
63 A	23	20	14	9	5	29	20	16	8	6

Nominal wattage	High pressure mixed			
	100 W	160 W	250 W	400 W
16 A	9	6	4	2
25 A	11	7	5	3
40 A	14	9	7	4
63 A	19	12	8	5

EMDX³ electrical energy meters

└ rail mounting

Technical characteristics

Single-phase meters Cat.Nos 0046 70/77

LCD display: 7 digits
 Resolution: 0.1 kWh
 Maximum indication: 99999.9 kWh
 Metrological LED: 1 Wh/pulse (Cat.No 0046 70 : 0.5 Wh/pulse)
 Accuracy (EN 62053-21): class 1
 Reference voltage Un: 230 V-240 V
 Reference frequency: 50-60 Hz
 Pulse output: 1 pulse/10 Wh
 (Cat.No 0046 70: 2 pulse/Wh)

Three-phase meters Cat.Nos 0046 80/84

LCD display: 8 digits
 Resolution: 0.01 kWh⁽¹⁾
 Maximum indication: 99999.99 kWh⁽¹⁾
 Metrological LED: 0.1 Wh/pulse or 1 Wh/pulse
 Active energy accuracy (EN 62053-21): class 1
 Reactive energy accuracy (EN 62053-23): class 2
 Reference voltage Un:
 - Single-phase: 230-240 V
 - Three-phase: 230(400)-240(415) V
 Operating limit range (EN 62053-21, EN 62053-23):
 - Single-phase: 110 to 254 V
 - Three-phase: 110(190) to 254(440) V
 Pulse output: 1 pulse/10 Wh

Cat.Nos		0046 70	0046 77	0046 80	0046 84
Number of modules		1	2	4	4
Connection	Direct	●	●	●	
	Via a current transformer				●
	Single-phase	●	●		●
	Three-phase			●	●
Max. current		32 A	63 A	63 A	5 A (CT)
Metering and measurement	Total active energy	●	●	●	●
	Total reactive energy			●	●
	Partial active energy (reset)		●	●	●
	Partial reactive energy (reset)			●	●
	Active power		●	●	●
	Reactive power			●	●
	Apparent power			●	●
	Current		●	●	●
	Voltage		●	●	●
	Frequency		●	●	●
	Power factor		●	●	●
	Time-of-use			●	
	Average active power				●
	Max. average active power value			●	●
Communication	Pulse output	●			●
	RS 485 interface		●	●	●
MID compliant					
Operating conditions	Reference temperature	23 °C ± 2 °C			
	Operating temperature	-20 to +55 °C	-10 to +45 °C	-5 to +55 °C	
	Storage temperature	-40 to +70 °C	-25 to +70 °C	-25 to +70 °C	
	Consumption	≤ 8 VA		≤ 4 VA per phase	≤ 1 VA per phase
	Heat dissipation	≤ 6.5 W		≤ 6 W	≤ 4 W

Interfacing with IP communication network

RS 485 electricity meters

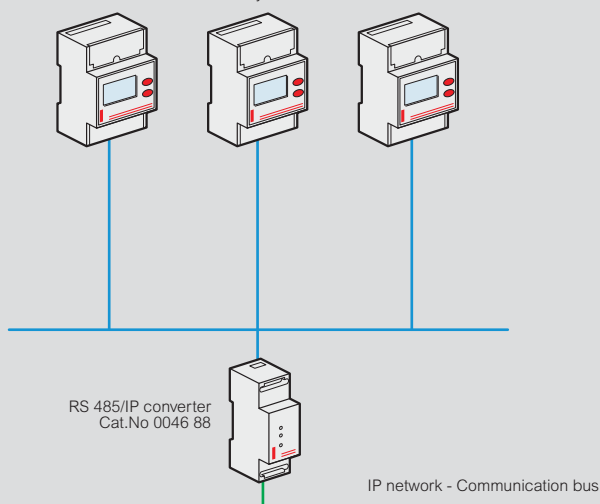

1: For direct connection meters
 If connected via transformers, the resolution and maximum indication depend on the transformation ratios of these transformers

EMDX³ multi-function measuring units

Technical characteristics

Cat.Nos		0046 76	
Connection	Current measurement terminals	4 mm ²	
	Other terminals	2.5 mm ²	
Protection index	Front cover	IP 51	
	Casing	IP 20	
Weight	205/215 g		
Display	Backlit LCD		
Measurements	3P+N, 3P, 2P, 1P+N		
Voltage measurement	Direct	Phase/phase	50 to 520 V \sim
		Phase/neutral	28 to 300 V \sim
		Primary	-
	From a PT	Secondary	-
		Permanent overload between phases	760 V \sim
	Update period	1 s	
Current measurement	From a CT	Primary	5 to 9999 A
		Secondary	5 A
	Minimum measurement	5 mA	
	Input consumption	< 0.6 VA	
	Display	0 to 9999 A	
	Permanent overload	6 A	
	Intermittent overload	60 A/1 s - 120 A/0.5 s	
	Update period	1 s	
Power measurement	Total	0 to 9999 kW/kvar/kVA	
	Update period	1 s	
Frequency measurement	Measurement range	45.0 to 65.0 Hz	
	Update period	1 s	
Auxiliary power supply	50/60 Hz	200 to 277 V \sim \pm 15%	
	DC	-	
Operating temperature	Consumption	< 5 VA	
	Storage temperature	-10 °C to +55 °C	
		-20 °C to +70 °C	

Connection solutions

Unbalanced three-phase network (3 or 4-wire)

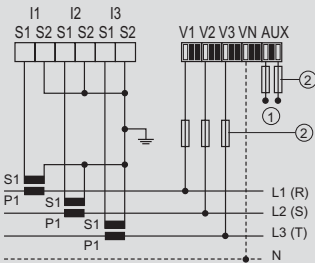

(3-wire)

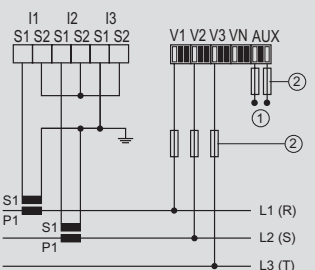
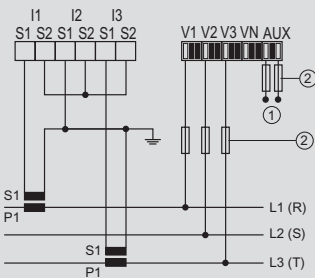

Balanced three-phase network (3 or 4-wire)

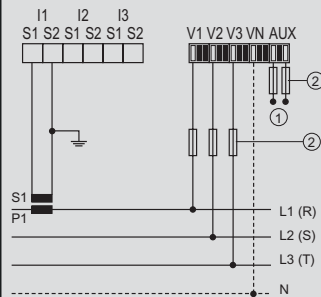

Single-phase network (2-wire)

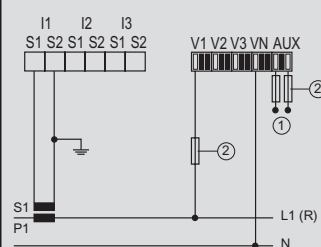

Two-phase network (2-wire)

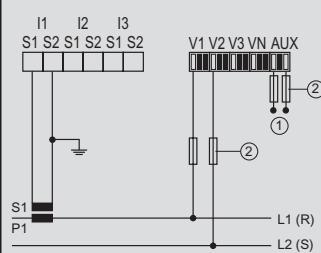

① Auxiliary power supply: 110 ... 400 VAC/120 ... 350 VDC
 ② Fuse: 0.5 A gG/BS 88 2 A gG/0.5 A class CC

Wiring example of communication network

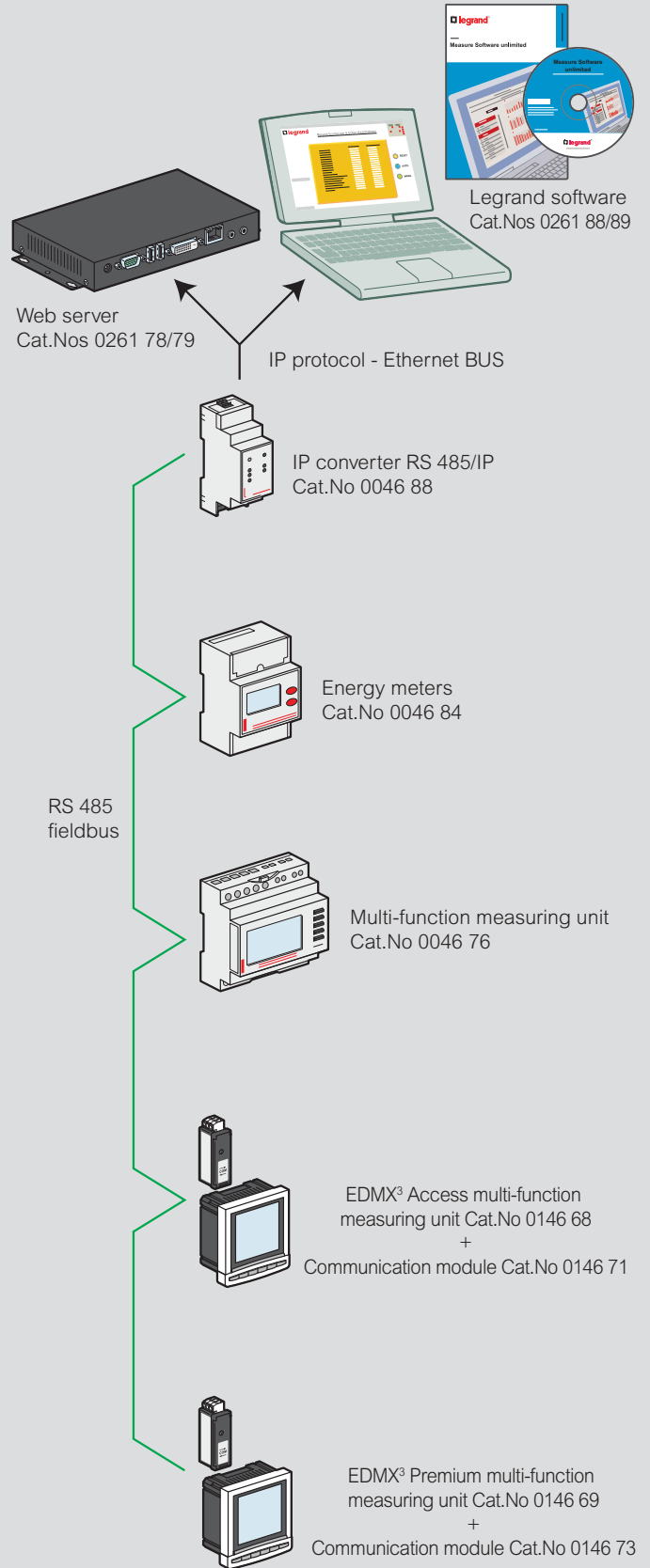

Surge Protective Devices (SPDs)

protection against transient overvoltages

Protection against lightning and overvoltages

Protection against the effects of lightning is essentially based on:

- Protecting buildings using a lightning protection system (LPS or lightning conductors) to catch lightning strikes and to drive the lightning current to earth.
- The use of surge protective devices (SPDs) to protect equipment.
- The design of the earthing system (passive protection of the installation).

Throughout the world, there are millions of lightning strikes each day in the summer (up to 1000 lightning strikes/second). Lightning is responsible for 25% to 40% of all damage to equipment. When added to industrial overvoltages (switching overvoltages due to the operation of internal equipment), they account for more than 60% of all electrical damages, which can be prevented by installing SPDs (according to the country and type of installation - source: insurance companies).

In some countries, and depending on the end use of the building, national regulations may always stipulate the installation of SPDs (for example, Germany, Austria, Norway, etc.). If there are no specific national regulations, SPDs are usually specified by national installation standards (based on HD/IEC 60364 international installation standards) and EN/IEC 62305 standards.

External lightning protection system (LPS) or lightning conductors: protection of buildings (EN/IEC 62305)

An external lightning protection system (LPS) protects buildings against direct lightning strikes. It is generally based on the use of lightning conductors (single rod, with sparkover device, meshed cage, etc.) and/or the metallic structure of the building.

If there is an LPS or if a lightning risk assessment has been carried out in accordance with EN/IEC 62305 standards, SPDs are generally required in the main distribution board (T1 SPDs) and distribution boards (T2 SPDs).

Determination of the SPDs in the main distribution board in accordance with EN/IEC 62305 and TS/IEC 61643-12 (if there is insufficient information available):

LPL: Lightning protection level	Total lightning current of the LPS	Min. value of Imp current of the SPD (T1)	Usage practices
I	200 kA	25 kA/pole (IT: 35 kA min.)	Power installations
II	150 kA	18.5 kA/pole	Rarely used
III/IV	100 kA	12.5 kA/pole	Small installations

1: LPL (Lightning Protection Level)

Surge protective device (SPD) (internal protection)

The SPD

- Protects sensitive devices against overvoltages caused by lightning and industrial overvoltages, by limiting the overvoltages to values that are tolerated by the equipment
- Limits the possible harmful consequences in terms of the safety of people (medical equipment installed in the home, security systems, environmental systems, etc.)
- Maximises the continuity of operation of equipment and limits production losses

SPDs and standards

Standards EN/IEC 61643-11

Type of SPD		Test waves
EN 61643-11	IEC 61643-11	
Type 1 (T1)	Class I (T1)	Iimp: 10/350 µs (discharge current) In: 8/20 µs (nominal current, 15 shocks)
Type 2 (T2)	Class II (T2)	I _{max} : 8/20 µs (discharge current) In: 8/20 µs (nominal current, 15 shocks)

T1+T2 SPDs: tested in accordance with both methods.

T1 or T1+T2 SPDs are being increasingly used at the supply origin of installations, even when there is no lightning conductor, as they enable higher energies to be discharged and increase the service life the SPD.

HD/IEC 60364 electrical installation standards

According to articles 443 and 534 of HD/IEC 60364 standards and the TS/IEC 61643-12 guides, the use of SPDs in new or renovated buildings is compulsory at the supply origin of the installation in the following cases:

- Buildings with lightning conductors (T1 SPDs, Iimp ≥ 12.5 kA)
- Buildings with totally or partially overhead power supplies in AQ2 geographical areas (article 443.3.2.1 - AQ2: Nk > 25, see map below) and based on a risk assessment taking into account the type of power supply to the building (article 443.3.2.2)

According to article 443.3.2.2, SPDs (Type 2) are also required in the following cases:

- Commercial/industrial buildings, public buildings and services, religious buildings, schools and large residential complexes, etc.
- Hospitals and buildings containing medical equipment and/or security systems for people and property (fire alarm, technical alarms, etc.)

Important: it is advisable to install an SPD when the safety of people may depend on the continuity of service of equipment (even if this is not required by national standards). Although not compulsory according to the installation standards, an SPD should always be installed to protect the communication equipment when there is an SPD on the low voltage power network.

These rules should change in 2015. Please consult Legrand.

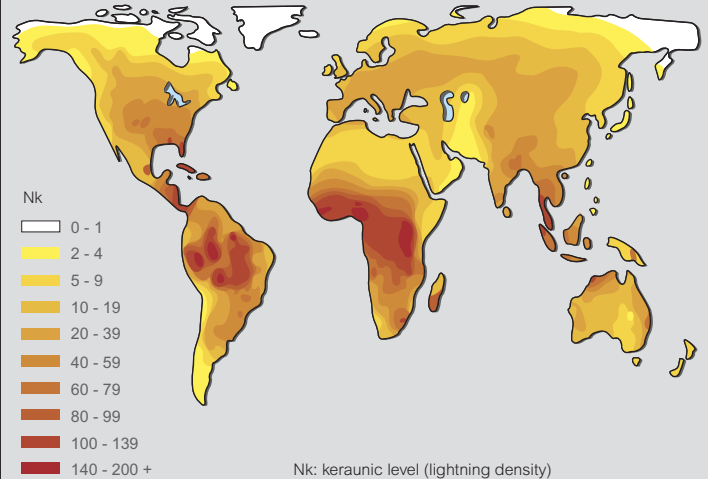

Protection of distribution boards and sensitive equipment (cascaded protection)

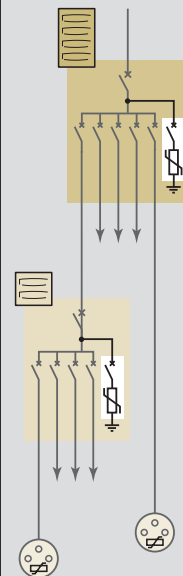

Effective protection against overvoltages cannot generally be assured with a single SPD if its protection level (Up) is greater than 1.2 kV (EN/IEC 62305 and TS/IEC 61643-12).

When there are overvoltages, an SPD protects equipment by limiting these overvoltages to values that can be tolerated by the equipment. Thus, depending on its discharge capacity (discharge current In, I_{max}, etc.) and its protection level (Up), an SPD will limit these overvoltages to varying values depending on the energy levels involved. The overvoltage values that may be transmitted downstream of the SPD may double over distances of more than 10 m due to resonances associated with the type of electrical installation and the type of equipment. Overvoltages greater than 2.5 kV may then occur and damage equipment if the residual energy is high enough (2.5 kV being the insulation level of most electrical and electronic equipment, or typically 1.5 kV for electrical domestic appliances).

SPDs should be installed in the distribution boards supplying equipment that is sensitive or critical for the activity being carried out (and/or near to equipment with proximity SPDs).

Surge Protective Devices (SPDs)

technical characteristics

Modular SPDs

230/400 V~ power network (50/60 Hz) - Degree of protection IP 20

Operating temperature: -10 to +40 °C/Storage temperature: -20 to +70 °C

1P+N (3P+N) SPDs: L-N and N-PE protection, also called 1+1 (3+1 resp.) or CT2 type protection depending on installation standards.

Cat.Nos	Type	Poles	Earthing system	Max. voltage (Uc)	Protection mode	Nominal current In/pole (8/20)	Max. discharge current			Protection level		Max. short-circuit current Isc (Isc cr)	Protective device to be used ¹	FS auxiliary (remote status monitoring)		
							I _{max} /pole (8/20)	I _{imp} /pole (10/350)	I _{total} (10/350)	Up (L-N/L-PE/N-PE)	Up at 5 kA					
0030 00 4122 80	T1/50 kA T1/35 kA	1P	TT, TNC, TNS, IT	440 V~	CT1	50 kA 35 kA		50 kA 35 kA	50 kA 35 kA	2.5 kV		50 kA	DPX ³ 160 80 A	no		
4122 81	T1/25 kA	1P+N	TT, TNS	350 V~	CT2	25/50 kA		25/50 kA	50 kA	1.5/2.5/1.5 kV				yes		
4122 82	T1/25 kA	3P	TNC	350 V~	CT1	25 kA		25 kA	75 kA	1.5 kV				yes		
4122 83	T1/25 kA	3P+N	TT, TNS	350 V~	CT2	25/100 kA		25/100 kA	100 kA	1.5/2.5/1.5 kV				yes		
4122 70	T1+T2/12.5 kA	1P	TT, TNC, TNS	320 V~	CT1	25 kA	60 kA	12.5 kA	12.5 kA	1.5 kV at 12.5 kA 1.9 kV at 25 kA	1 kV	50 kA	DX ³ 63 A C curve	no		
4122 71	T1+T2/12.5 kA	2P	TT, TNS	320 V~	CT1	25 kA	60 kA	12.5 kA	25 kA							no
4122 72	T1+T2/12.5 kA	3P	TNC	320 V~	CT1	25 kA	60 kA	12.5 kA	37.5 kA							yes
4122 73	T1+T2/12.5 kA	4P	TT, TNS	320 V~	CT1	25 kA	60 kA	12.5 kA	50 kA					no		
4122 76	T1+T2/12.5 kA	1P+N	TT, TNS	320 V~	CT2	25/25 kA	60 kA	12.5/25 kA	25 kA	1.5/1.6/1.5 kV at 12.5 kA 1.9/2.1/1.5 kV at 25 kA	1 kV		yes			
4122 77	T1+T2/12.5 kA	3P+N	TT, TNS	320 V~	CT2	25/50 kA	60 kA	12.5/50 kA	50 kA					yes		
4122 50	T1+T2/8 kA	1P	TT, TNC, TNS	320 V~	CT1	20 kA	50 kA	8 kA	8 kA	1.2 kV at 8 kA 1.7 kV at 20 kA	1 kV	50 kA	DX ³ 40 A C curve	no		
4122 51	T1+T2/8 kA	2P	TT, TNS	320 V~	CT1	20 kA	50 kA	8 kA	16 kA							no
4122 52	T1+T2/8 kA	3P	TNC	320 V~	CT1	20 kA	50 kA	8 kA	25 kA							no
4122 53	T1+T2/8 kA	4P	TT, TNS	320 V~	CT1	20 kA	50 kA	8 kA	32 kA					no		
4122 56	T1+T2/8 kA	1P+N	TT, TNS	320 V~	CT2	20 kA	50 kA	8 kA	16 kA	1.2/1.5/1.5 kV at 8 kA 1.7/2/1.5 kV at 20 kA	1 kV		no			
4122 57	T1+T2/8 kA	3P+N	TT, TNS	320 V~	CT2	20 kA	50 kA	8 kA	25 kA					no		
4122 40	T2/40 kA	1P	TT, TNC, TNS	320 V~	CT1	20 kA	40 kA			1.5 kV at 15 kA 1.7 kV at 20 kA	1 kV	50 kA	DX ³ 25 A C curve	no		
4122 41	T2/40 kA	2P	TT, TNS	320 V~	CT1	20 kA	40 kA									no
4122 42	T2/40 kA	3P	TNC	320 V~	CT1	20 kA	40 kA									yes
4122 43	T2/40 kA	4P	TT, TNS	320 V~	CT1	20 kA	40 kA									no
4122 46 4122 66	T2/40 kA	1P+N	TT, TNS	320 V~	CT2	20 kA	40 kA			1.5/1.6/1.4 kV at 15 kA 1.7/2/1.4 kV at 20 kA	1 kV	50 kA 25 kA	DX ³ 25 A C curve	no		
4122 47 4122 67	T2/40 kA	3P+N	TT, TNS	320 V~	CT2	20 kA	40 kA									no
4122 30	T2/40 kA	1P	TT, TNC, TNS, IT	440 V~	CT1	20 kA	40 kA			1.8 kV at 15 kA 2.1 kV at 20 kA	1.3 kV			50 kA	DX ³ 25 A C curve	no
4122 32	T2/40 kA	3P	TNC, IT	440 V~	CT1	20 kA	40 kA									
4122 33	T2/40 kA	4P	TT, TNS, IT	440 V~	CT1	20 kA	40 kA									yes
4122 20	T2/20 kA	1P	TT, TNS	320 V~	CT1	10 kA	20 kA			1.2 kV at 5 kA 1.4 kV at 10 kA	1.2 kV	25 kA	DX ³ 20 A C curve	no		
4122 21	T2/20 kA	2P	TT, TNS	320 V~	CT1	10 kA	20 kA									no
4122 23	T2/20 kA	4P	TT, TNS	320 V~	CT1	10 kA	20 kA									no
4122 26 4122 62	T2/20 kA	1P+N	TT, TNS	320 V~	CT2	10/20 kA	20 kA			1.2/1.4/1.4 kV at 5 kA 1.4/1.4/1.4 kV at 10 kA	1.2 kV				no	
4122 27 4122 63	T2/20 kA	3P+N	TT, TNS	320 V~	CT2	10/20 kA	20 kA							no		
0039 51 0039 71	T2+T3/12 kA	1P+N	TT, TNS	275 V~	CT2	10/10 kA	12 kA			1.1/1.2/1.2 kV at 10 kA	1 kV	6 kA 10 kA	integrated protection	no		
0039 53 0039 73	T2+T3/12 kA	3P+N	TT, TNS	275 V~	CT2	10/20 kA	20 kA									

CT1: L(N)-PE protection modes.

CT2: L-N and N-PE protection modes.

1: DPX³ (with T1 SPDs), DX³ or similar type circuit breakers (with T2 and T1+T2 SPDs). For fuse protection or values other than those indicated in the table: please consult Legrand.

Characteristics of proximity SPDs

230 V~ protection: Type 3 (T3) SPDs

Cat.Nos	0775 40	6946 64/66/70	6946 14/48/51/56/71
Protection mode	LN/NPE	LN/LPE/NPE	LN
Up	1/1.2 kV	1 kV	1 kV
I _{max}	6 kA	-	-
I _n	1.5 kA	2 kA	2 kA
U _{oc}	3 kV	4 kV	4 kV

TT earthing system: Installation downstream of a residual current device (HPI type recommended).

RJ 45/RJ 11 protection

Cat. No.	6946 64	6946 70
U _c		200 V
U _p		600 V
I _{max}		1.5 kA
I _n		1 kA
U _{oc}		3 kV

TV protection (9.5 mm coax.)

Cat. No.	6946 66
U _c	50 V
U _p	900 V
I _{max}	5 kA
I _n	1 kA
U _{oc}	3 kV

Surge Protective Devices (SPDs)

technical characteristics

Installation

Associated overcurrent protection

SPDs must be protected by a circuit breaker (or fuses), to provide protection in the event of an overload, which may make the SPD reach its end of life (see selection table p. 10-11). This protective device will be defined to be coordinated or discriminating with regard to upstream protective devices.

Connection principles

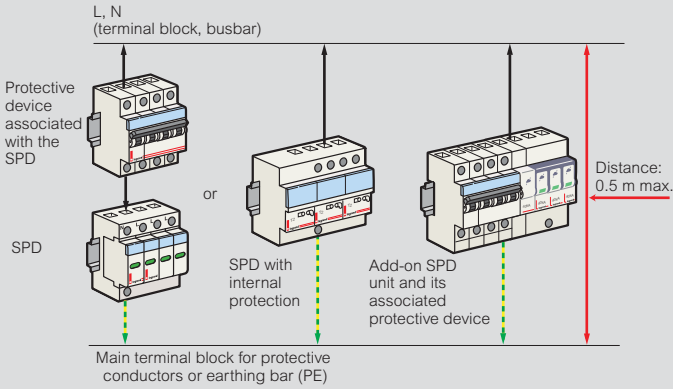

Connection lengths: as short as possible (< 50 cm if possible).
EMC (Electromagnetic Compatibility) rules: avoid loops, fix the cables firmly against the exposed metal conductive parts of the enclosure.

SPD types and earthing systems

When possible (according to local rules), the SPD and its associated overcurrent protection (P2) should be installed upstream of the main protection (P1) as shown below (according to standards HD/IEC 60364).

SPDs and TT earthing system

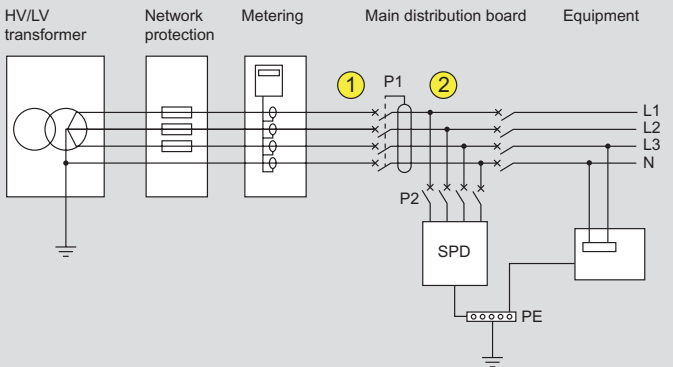

P1: main protection of the installation
SPD: surge protective device with Uc 275 or 320 V recommended
① (upstream of P1): 1P+N/3P+N SPDs only (except for Cat.Nos 0039 51/53/71/73).
1P/2P/3P/4P SPDs and Cat.Nos 0039 51/53/71/73 must always be installed downstream of a residual current device (discriminating or delayed, at the supply end of the installation).
② (downstream of P2): any SPD.

SPDs and TN (TNC, TNS and TNC-S) earthing systems

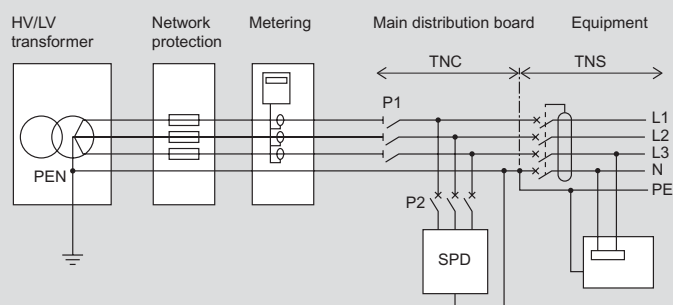

P1: main protection of the installation
SPD: surge protective device with Uc 275 or 320 V recommended

SPDs and IT earthing system

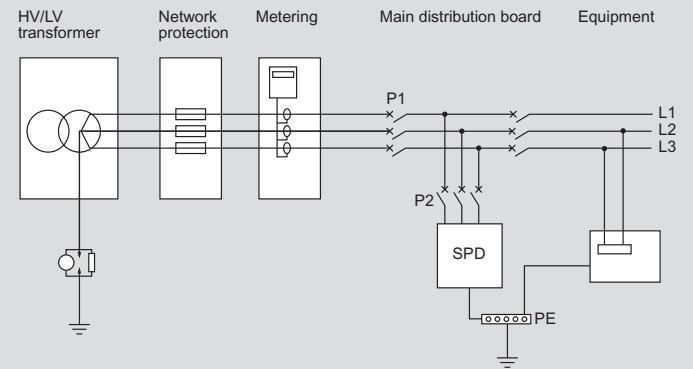

P1: main protection of the installation
SPD: surge protective device with Uc 440 V (Uc < 440 V prohibited)

Coordinating upstream/downstream SPDs

Consists of ensuring that any downstream SPD (in distribution enclosures or proximity SPDs) is correctly coordinated in energy terms with any SPD located upstream (TS 61643-12).

Minimum distances between SPDs

Upstream SPD	Downstream SPD	Min. distance (m)
T1/50 and T1/25	T2/40	10
T1/12.5 and T1/8	T2/40	6
	T2/20, T2/12	8
T2/40	T2/20	4
	T2/12	6
T2/20 and T2/12	Proximity SPD	2

If it is not possible to comply with these distances, insert decoupling inductors on each phase and neutral conductor.