

## DX<sup>3</sup> RCBOs

RCBOs compact for AC applications upto 32 A, 6 kA



## DX<sup>3</sup> RCD add on module

For 125 A



Technical characteristics p. 46-51

| Pack | Cat.Nos        | DX <sup>3</sup> RCBOs, 2 pole 240 V $\sim$   |                   |
|------|----------------|--|-------------------|
|      |                | ISI marked as per IEC 61009<br>Integrated label holder<br>Ergonomic design<br>Color coded On/Off indication on dolly<br>Front face indication for earth leakage fault<br>IP 20 protected terminals<br>35 sq mm terminals<br>Sliding shutters |                   |
|      |                | <b>AC Type</b>   |                   |
|      |                | <b>30 mA</b>   |                   |
|      |                | Nominal rating In (A)  | Number of modules |
| 1/32 | <b>4113 90</b> | 6  | 2                 |
| 1/32 | <b>4113 91</b> | 10   | 2                 |
| 1/32 | <b>4113 92</b> | 16   | 2                 |
| 1/32 | <b>4113 93</b> | 20   | 2                 |
| 1/32 | <b>4113 94</b> | 25   | 2                 |
| 1/32 | <b>4113 95</b> | 32   | 2                 |
|      |                | <b>300 mA</b>  |                   |
| 1/32 | <b>4113 97</b> | 6  | 2                 |
| 1/32 | <b>4113 98</b> | 10   | 2                 |
| 1/32 | <b>4113 99</b> | 16   | 2                 |
| 1/32 | <b>4114 00</b> | 20   | 2                 |
| 1/32 | <b>4114 01</b> | 25   | 2                 |
| 1/32 | <b>4114 02</b> | 32   | 2                 |
|      |                | <b>HPI Type</b>  |                   |
|      |                | <b>30 mA</b>   |                   |
| 1/32 | <b>4114 15</b> | 25   | 2                 |
| 1/32 | <b>4114 16</b> | 32   | 2                 |

Technical characteristics p. 46-51

Conform to IEC 60947-2  
 AC type : detect AC components faults  
 Hpi type : detect faults with AC and DC components, increased immunity to false tripping  
 For mounting on the right-hand side of 1.5 module per pole DX<sup>3</sup> MCBs  
 Easy & fast association mechanism  
 Terminal cover for locking  
 70 sq mm terminals

| Pack | Cat.Nos        | DX <sup>3</sup> RCBOs, 4 pole 415 V $\sim$   |                   |
|------|----------------|--|-------------------|
|      |                | Complies to per IEC 61009<br>Integrated label holder<br>Ergonomic design<br>Color coded On/Off indication on dolly<br>Front face indication for earth leakage fault<br>IP 20 protected terminals<br>35 sq mm terminals<br>Sliding shutters |                   |
|      |                | <b>AC Type</b>   |                   |
|      |                | <b>30 mA</b>   |                   |
|      |                | Nominal rating In (A)  | Number of modules |
| 1/16 | <b>4111 85</b> | 10   | 4                 |
| 1/16 | <b>4111 86</b> | 16   | 4                 |
| 1/16 | <b>4111 87</b> | 20   | 4                 |
| 1/16 | <b>4111 88</b> | 25   | 4                 |
| 1/16 | <b>4111 89</b> | 32   | 4                 |
|      |                | <b>300 mA</b>  |                   |
| 1/16 | <b>4112 04</b> | 10   | 4                 |
| 1/16 | <b>4112 05</b> | 16   | 4                 |
| 1/16 | <b>4112 06</b> | 20   | 4                 |
| 1/16 | <b>4112 07</b> | 25   | 4                 |
| 1/16 | <b>4112 08</b> | 32   | 4                 |
|      |                | <b>A Type</b>  |                   |
|      |                | <b>30 mA</b>   |                   |
| 1/16 | <b>4112 33</b> | 10   | 4                 |
| 1/16 | <b>4112 34</b> | 16   | 4                 |
| 1/16 | <b>4112 35</b> | 20   | 4                 |
| 1/16 | <b>4112 36</b> | 25   | 4                 |
| 1/16 | <b>4112 37</b> | 32   | 4                 |
|      |                | <b>300 mA</b>  |                   |
| 1/16 | <b>4112 38</b> | 10   | 4                 |
| 1/16 | <b>4112 39</b> | 16   | 4                 |
| 1/16 | <b>4112 40</b> | 20   | 4                 |
| 1/16 | <b>4112 41</b> | 25   | 4                 |
| 1/16 | <b>4112 42</b> | 32   | 4                 |

| Pack | Cat.Nos        | DX <sup>3</sup> RCD                               |                   |
|------|----------------|---|-------------------|
|      |                | <b>2 pole 240 V<math>\sim</math>, AC Type</b>     |                   |
|      |                | Nominal rating In (A)                             | Number of modules |
| 1    | <b>4105 68</b> | 125 A   | 4                 |
| 1    | <b>4105 69</b> | 125 A   | 4                 |
| 1    | <b>4105 71</b> | 125 A   | 4                 |
|      |                | <b>4 pole 415 V<math>\sim</math>, AC Type</b>     |                   |
|      |                | <b>30 mA</b>                                      |                   |
| 1    | <b>4106 25</b> | 125 A   | 4                 |
| 1    | <b>4106 26</b> | 125 A   | 4                 |
| 1    | <b>4106 29</b> | 125 A   | 4                 |
|      |                | <b>2 pole 240 V<math>\sim</math>, HPI type</b>    |                   |
|      |                | <b>30 mA</b>                                      |                   |
| 1    | <b>4105 78</b> | 125 A   | 6                 |
| 1    | <b>4105 79</b> | 125 A   | 6                 |
| 1    | <b>4105 82</b> | 125 A   | 6                 |
|      |                | <b>Four pole 415 V<math>\sim</math>, HPI type</b> |                   |
|      |                | <b>30 mA</b>                                      |                   |
| 1    | <b>4106 38</b> | 125 A   | 6                 |
| 1    | <b>4106 39</b> | 125 A   | 6                 |
| 1    | <b>4106 42</b> | 125 A   | 6                 |

## ■ Technical data

### Nature and consequences of electrical risks

#### Direct and indirect contact

All electrical risks for people are the result of direct or indirect contact. What are these contacts? And how can we protect ourselves against them?

All the answers appear in the following section.

Electrical risks do not just concern people : these risks - especially fire affect installations as well. A 500 mA current, for example, flowing through combustible material is sufficient to ignite such material after a certain time. Every electrical installation is subject to current leakages which can vary considerably depending on such factors as the installation's condition, age, environment, etc.

These current leaks may flow through the fabric of the building (trunking, metal girders or other metal components), generating heat which in turn may lead to fire.

#### Direct contacts

Direct contact is caused by humans and may be due to either carelessness or clumsiness.

#### What is a direct contact? How can we protect ourselves? Here are the answers...

This is when someone makes contact with a live electrical component of a device or installation.

For example :

- a person inadvertently touching a live cable.
- a child sticking a metal object into a power socket.
- using male/male extensions or unprotected test cables.

#### In this case only basic protection is effective



#### Other examples

Someone touching a live busbar in a distribution panel or cabinet, or someone touching flush-mounted electrical trunking with the end of a tool, etc. In this case basic protection plus additional protection is effective.

#### How can we protect ourselves?

There are two ways (independent of the neutral earthing system) of ensuring that personnel are protected against direct contact.

##### • Preventing access to live parts where possible.

Basic protection via physical or electrical isolation of live parts.

This protection must ensure that live parts cannot be touched, even inadvertently.

How?

By using barriers, enclosures, closed cabinets which physically or electrically isolate live parts presenting a danger to the user, shuttered sockets, or insulation.

##### • Additional protection

Must be provided by a 30 -mA residual current device such as Lexic range of residual current devices. This protection is required in case the basic protection detailed above fails.

**■ Technical data**

**Indirect contacts**

Indirect contacts are independent of humans : it results from an internal hardware fault.

**What is an indirect contact?**

**How can we protect ourselves? Here are the answers...**

**What is an indirect contact?**

This is when a person makes contact with a metal earthed part which has accidentally been powered up following an insulation fault. This type of contact is very dangerous as, unlike direct contact, it is completely unexpected. For example, a person touching the metal frame of an electrical appliance which has defective insulation may be electrocuted through no fault of their own if the appliance is not protected.

**How can we protect ourselves?**

There are three possibilities :

- Preventing to potentially dangerous metal components via class II protection.
- Grounding of all exposed conductive parts to an effective earth.
- Protective RCD according to the neutral earthing system.



**A person is in danger of electrocution if the fault current raises the voltage of the accessible metal part above 50 V to earth.**

**Important note:**

Under the Indian Electricity Rules [rules 61 (A), 71 (1) and 73 (1)], installation of an RCCB is mandatory in all installations of 5 KW and above, in all luminous tube signs and X-ray installations. The bureau of Indian standards recommends that RCCBs installed at construction sites, temporary installations, agriculture and horticulture premises, limit the residual current to 30 mA.

**Residual current devices, selection and operation**

The main function of a residual current device is to ensure that people are protected from any risk of electrocution. It can also ensure protection against risk of fire.

**What is the nature of these risks? What are the consequences?**

**Here are the answers...**

**Risks of electrocution-**

The dangerous effects of electricity depend on two factors :-

- the flowing time through the human body
- the current value

These two factors are independent and the importance of the risk varies in accordance with the level of each factor.

The dangerous current value through a human body depends on the touch voltage and touch resistance of the human body.

In practice, the current value is defined using a standard "safety" voltage of 50 V. This voltage takes into account the maximum current which can be withstood by a human being with a minimum internal electrical resistance in given conditions. It also takes into account the maximum permissible time for the current to pass through the body without dangerous physio-pathological effects.

50 V is considered as the safe limit of voltage for human body in dry condition.

**How does an electrical current affect the human body?**

When subject to a voltage, the human body reacts like any other receiver with a given internal resistance. An electrical current passes through the body with three serious risks :

- **Locking** the muscles, or tetanisation : the muscles through which the current passes contract and remain contracted : if this includes the rib cage, breathing may be impeded.
- **Action** on heart : the cardiac rhythm is completely disrupted (ventricular fibrillation).
- **Thermal** effects may cause varying levels of damage to body tissue, including severe burns in the case of very high currents.



**Examples of electrocution by direct or indirect contact.**

**Technical data**

**Effect of current on human body**

The standards define the following curves, which take into account the two parameters required to assess the risk:

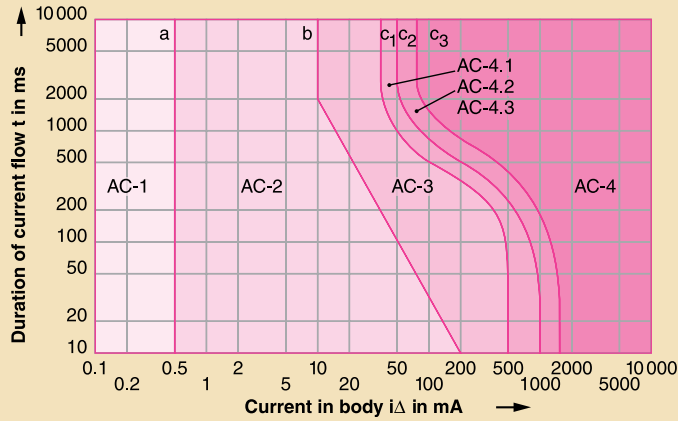

$i\Delta$ : current flowing through body  
 $t$ : time taken for current to pass through body.

These curves show the various zones of effect of an alternating current on people: they derive from IEC 60 479 and determine

**4 main risk zones**

| Zone designation | Physiological effects  |
|------------------|--|
| zone AC-1        | Usually no reaction  |
| zone AC-2        | Usually no harmful physiological effects   |
| zone AC-3        | Usually no organic damage to be expected. Likelihood of cramp like muscular contractions and difficulty in breathing for durations of current-flow longer than 2 s. Reversible disturbances of formation and conduction of impulses in the heart, including atrial fibrillation and transient cardiac arrest without ventricular fibrillation increasing with current magnitude and time |
| zone AC-4        | Increasing with magnitude and time, dangerous pathophysiological effects such as cardiac arrest, breathing arrest and serious burns may occur in addition to the effects of zone-3   |
| zone AC-4.1      | Probability of ventricular fibrillation increasing up to about 5% C1 - C2  |
| zone AC-4.2      | Probability of ventricular fibrillation up to about 50% C2 - C3  |
| zone AC-4.3      | Probability of ventricular fibrillation above 50%  |

\* For durations of current flow below 10 ms, the limit for the body current at line b remains constant at a value of 200 mA.

A residual current device continuously measures the difference between the value of the input and the output currents. If the value is not equal to zero, this indicates a leak.

When this leak reaches the level at which the differential is set (its sensitivity), the device trips and breaks the circuit.

**What are the operating principles of a residual current device?**

**What are the selection criteria for a residual current device? Here are the answers...**

**Operating principle of a residual current device**

**No fault present**

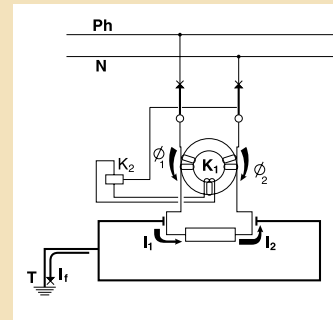

Therefore no current is induced in coil  $K_1$ , and coil  $K_2$  is not excited. The contacts do not open. The equipment operates normally

$I_f = 0$ , thus

$I_1 = I_2$

$\Phi_1 = \Phi_2$

$\Phi_1 - \Phi_2 = 0$

**Insulation fault**

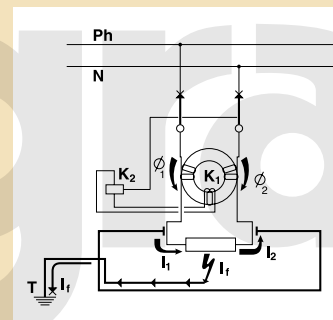

**A current is thus induced in coil  $K_1$ ...**

$I_f \neq 0$

$I_1 > I_2$ , thus

$\Phi_1 > \Phi_2$ , thus

$\Phi_1 - \Phi_2 \neq 0$

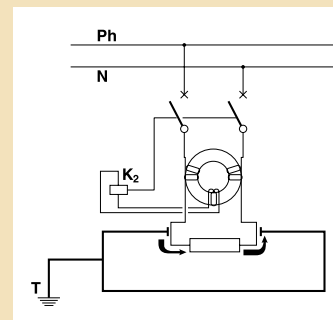

**...coil  $K_2$  is excited, the contacts open and the equipment is automatically switched OFF**

**Selecting a residual current device**

First determine your requirement. This exists on two levels :

**1** The need to protect against direct or indirect contacts.

**2** The need to ensure protection against overloads and short-circuits.

If protection against indirect contact is required, use residual current devices with a sensitivity of :

30 mA,

100 mA,

300 mA,

The rating (40, 63 A, etc.) is selected according to the load.

If protection against direct contact is required, use residual current device with a sensitivity of 30 mA.

The sensitivity of a residual current device  $I \Delta n$  is the current level at which tripping is sure to occur. To do this, the standards concerning residual current devices stipulate that tripping must occur between  $I \Delta n / 2$  and  $I \Delta n$ .

■ **Technical data**

**Types of residual current device**

There are 2 types of RCD: the AC type and the A type  
Both types are produced in the "S" (discriminating) or normal versions. They conform to Indian and International standards IS 12640, IEC 61008 and IEC 61009 as well as European standards EN 61008 and EN 61009.

• **Type A** 

Sensitive to residual alternating currents and residual currents with a DC component.

Use: special applications

- if it is possible that the fault currents are not purely sinusoidal (rectifier bridge, etc.)

• **Type AC** 

Sensitive to residual alternating currents

Use: standard applications

• **Type S** 

Delayed trip for discrimination with other residual current devices.

Use: for discrimination with a downstream device.

• **Type Hpi** 

• Enhanced immunity to unwanted tripping in environments with disturbances. eg. diesels, computers, printers, etc.

• Detects faults with DC components eg. thyristors, triac etc.

**Residual current circuit-breaker with or without overload protection? Which do I choose?**

Choose a residual current circuit-breaker (RCCB) if you do not need to protect against overload and short circuits (caution! an RCCB must be connected to some form of line protection device: either a circuit-breaker or a fuse).

Choose a residual current circuit-breaker with overload and short circuit protection (RCBO) if this type of protection is not available.

**Residual current circuit-breakers without overload and short circuit protection (RCCB)**



These provide two functions: fault current detection, measurement and cut-off: and isolation of an installation.

RCCBs are governed by standards IS 12640 (part 1), IEC 61008-1.

**Residual current circuit-breakers with overload and short circuit protection (RCBO)**



These provide three functions: fault current detection, measurement and cut-off: protection against overloads and short-circuits : and isolation of an installation.

Residual current circuit-breakers are governed by standards IS 12640 (part 2), IEC 61009-1.

**The "test" function**

A residual current device is a safety device, and it is therefore vital that it is regularly tested. This function is therefore required by the standard governing residual current protective devices, and ensures correct operation. All Lexic RCDs are equipped with this function.

**Note :** We offer Type AC, Type A-S and Type Hpi RCDs

■ **Compatibility MCBs/add-on modules**

| Breaking capacity | Number of poles | Add-on module for 1.5 module/pole MCBs |
|-------------------|-----------------|--|
| 16 kA             | 2P, 4P          | In ≥ 80 A                              |
| 25 kA             | 4P              | In ≥ 32 A                              |
|                   | 2P              | In ≥ 40 A                              |
|                   | 4P              | In ≥ 12,5 A                            |
|                   | 2P              | In ≥ 32 A                              |
| 50 kA             | 2P, 4P          | All range                              |

## ■ Technical data

### Types of residual current device

There are 2 types of RCD: the AC type and the A type

Both types are produced in the "S" (discriminating) or normal versions. They conform to Indian and International standards IS 12640, IEC 61008 and IEC 61009 as well as European standards EN 61008 and EN 61009.

• **Type A** 

Sensitive to residual alternating currents and residual currents with a DC component.

Use: special applications

- if it is possible that the fault currents are not purely sinusoidal (rectifier bridge, etc.)

• **Type AC** 

Sensitive to residual alternating currents

Use: standard applications

• **Type S** 

Delayed trip for discrimination with other residual current devices.

Use: for discrimination with a downstream device.

• **Type Hpi** 

• Enhanced immunity to unwanted tripping in environments with disturbances. eg. diesels, computers, printers, etc.

• Detects faults with DC components eg. thyristors, triac etc.

### Residual current circuit-breaker with or without overload protection? Which do I choose?

Choose a residual current circuit-breaker (RCCB) if you do not need to protect against overload and short circuits (caution! an RCCB must be connected to some form of line protection device: either a circuit-breaker or a fuse).

Choose a residual current circuit-breaker with overload and short circuit protection (RCBO) if this type of protection is not available.

### Residual current circuit-breakers without overload and short circuit protection (RCCB)



These provide two functions: fault current detection, measurement and cut-off: and isolation of an installation.

RCCBs are governed by standards IS 12640 (part 1), IEC 61008-1.

### Residual current circuit-breakers with overload and short circuit protection (RCBO)



These provide three functions: fault current detection, measurement and cut-off: protection against overloads and short-circuits : and isolation of an installation.

Residual current circuit-breakers are governed by standards IS 12640 (part 2), IEC 61009-1.

### The "test" function

A residual current device is a safety device, and it is therefore vital that it is regularly tested. This function is therefore required by the standard governing residual current protective devices, and ensures correct operation. All Lexic RCDs are equipped with this function.

**Note :** We offer Type AC, Type A-S and Type Hpi RCDs

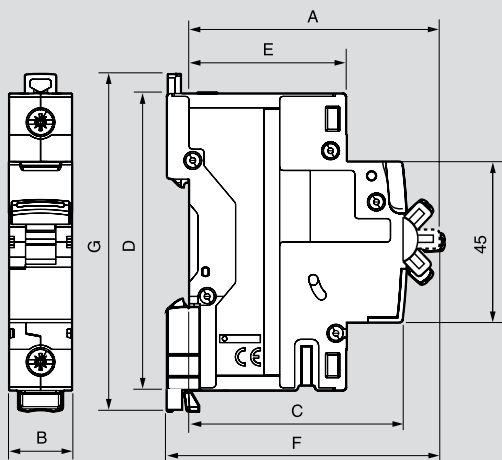
**Dimensions**

| Products                                    | A    | B    |      |      |      |      |       | C  | D  | E  | F    | G  |
|---|------|------|------|------|------|------|-------|----|----|----|------|----|
|   |      | SP   | SPN  | DP   | TP   | TPN  | FP    |    |    |    |      |    |
| DX <sup>3</sup> MCBs (0.5 to 63A)           | 70   | 17.7 | 35.6 | 35.6 | 53.4 | 71.2 | 71.2  | 60 | 83 | 44 | 76   | 94 |
| DX <sup>3</sup> MCBs (80 - 125A)            | 70   | 26.7 | -    | 53.4 | 80.1 | -    | 106.8 | 60 | 83 | 44 | 76   | 89 |
| DX <sup>3</sup> Isolators                   | 70   | -    | -    | 35.6 | 53.4 | -    | 71.2  | 60 | 83 | 44 | 76   | 94 |
| DX <sup>3</sup> RCCB - type AC (DP)         | 70   | -    | -    | 35.6 | -    | -    | -     | 60 | 83 | 44 | 76   | 94 |
| DX <sup>3</sup> RCCB - type AC (FP)         | 71.5 | -    | -    | -    | -    | -    | 71.2  | 60 | 83 | 44 | 77.5 | 94 |
| DX <sup>3</sup> RCCB - type A - S (DP)      | 70   | -    | -    | 35.6 | -    | -    | -     | 60 | 83 | 44 | 76   | 94 |
| DX <sup>3</sup> RCCB - type A - S (FP)      | 71.5 | -    | -    | -    | -    | -    | 71.2  | 60 | 83 | 44 | 77.5 | 94 |
| DX <sup>3</sup> RCCB - type Hpi (DP)        | 70   | -    | -    | 35.6 | -    | -    | -     | 60 | 83 | 44 | 76   | 94 |
| DX <sup>3</sup> RCCB - type Hpi (FP)        | 71.5 | -    | -    | -    | -    | -    | 71.2  | 60 | 83 | 44 | 77.5 | 94 |
| DX <sup>3</sup> RCBO - type AC              | 70   | -    | -    | 71.2 | -    | -    | 142.4 | 60 | 83 | 44 | 76   | 94 |
| DX <sup>3</sup> RCBO - type AC (DP 2 mod.)  | 70   | -    | -    | 35.6 | -    | -    | -     | 60 | 83 | 44 | 76   | 94 |
| DX <sup>3</sup> RCBO - type Hpi (DP 2 mod.) | 70   | -    | -    | 35.6 | -    | -    | -     | 60 | 83 | 44 | 76   | 94 |
| Auxiliary contacts                          | 70   |      |      |      | 8.7  |      |       | 60 | 83 | 44 | 76   | 83 |
| Auxiliary contacts                          | 70   |      |      |      | 17.7 |      |       | 60 | 83 | 44 | 76   | 83 |
| Shunt trip                                  | 70   |      |      |      | 17.7 |      |       | 60 | 83 | 44 | 76   | 83 |
| Minimum voltage trip                        | 70   |      |      |      | 17.7 |      |       | 60 | 83 | 44 | 76   | 83 |
| POP over voltage                            | 74   |      |      |      | 54   |      |       | 74 | 83 | 44 | 80.5 | 89 |
| Remote control for MCB / RCBO               | 74   |      |      |      | 54   |      |       | 74 | 83 | 44 | 80.5 | 89 |
| Lexic contactors 20 A                       | 62   |      |      |      | 17.8 |      |       | 60 | 83 | 44 | 67.5 | -  |
| Lexic contactors 40 A (2 mod.)              | 60   |      |      |      | 35.6 |      |       | 61 | 80 | 44 | 67   | -  |
| Lexic contactors 40 A / 63 A (3 mod.)       | 60   |      |      |      | 54   |      |       | 61 | 80 | 44 | 67   | -  |