

3-pole contactors CTX³

9 A to 100 A industrial contactors



Technical characteristics **p. 188**
Dimensions and coordination with circuit breakers **see e-catalogue**

Conform to IEC 60947-1, IEC 60947-4-1
Can be equipped with RTX³ thermal relays (p. 184) add-on auxiliary contact blocks, time delay blocks, capacitor switching units and CTX³ interlocking (p. 186)

Pack	Cat.Nos	CTX³ 22		
		With integrated auxiliary contacts Power terminals: screw terminals		
		9 A (AC3) - 25 A (AC1)		
		3-phase motor 400/415 V	Control Voltage	Integrated auxiliary contacts
1	4 160 80	4 kW	24 V~	1 NO + 1 NC
1	4 160 81	4 kW	24 V=	1 NO + 1 NC
1	4 160 84	4 kW	110 V~	1 NO + 1 NC
1	4 160 86	4 kW	230 V~	1 NO + 1 NC
1	4 160 89	4 kW	415 V~	1 NO + 1 NC
		12 A (AC3) - 25 A (AC1)		
1	4 160 90	5.5 kW	24 V~	1 NO + 1 NC
1	4 160 91	5.5 kW	24 V=	1 NO + 1 NC
1	4 160 94	5.5 kW	110 V~	1 NO + 1 NC
1	4 160 96	5.5 kW	230 V~	1 NO + 1 NC
1	4 160 99	5.5 kW	415 V~	1 NO + 1 NC
		18 A (AC3) - 40 A (AC1)		
1	4 161 00	7.5 kW	24 V~	1 NO + 1 NC
1	4 161 01	7.5 kW	24 V=	1 NO + 1 NC
1	4 161 04	7.5 kW	110 V~	1 NO + 1 NC
1	4 161 06	7.5 kW	230 V~	1 NO + 1 NC
1	4 161 09	7.5 kW	415 V~	1 NO + 1 NC
		22 A (AC3) - 40 A (AC1)		
1	4 161 10	11 kW	24 V~	1 NO + 1 NC
1	4 161 11	11 kW	24 V=	1 NO + 1 NC
1	4 161 14	11 kW	110 V~	1 NO + 1 NC
1	4 161 16	11 kW	230 V~	1 NO + 1 NC
1	4 161 19	11 kW	415 V~	1 NO + 1 NC

Pack	Cat.Nos	CTX³ 40		
		With integrated auxiliary contacts Power terminals: screw terminals		
		32 A (AC3) - 50 A (AC1)		
		3-phase motor 400/415 V	Control Voltage	Integrated auxiliary contacts
1	4 161 20	15 kW	24 V~	2 NO + 2 NC
1	4 161 21	15 kW	24 V=	2 NO + 2 NC
1	4 161 24	15 kW	110 V~	2 NO + 2 NC
1	4 161 26	15 kW	230 V~	2 NO + 2 NC
1	4 161 29	15 kW	415 V~	2 NO + 2 NC
		40 A (AC3) - 60 A (AC1)		
1	4 161 30	18.5 kW	24 V~	2 NO + 2 NC
1	4 161 31	18.5 kW	24 V=	2 NO + 2 NC
1	4 161 34	18.5 kW	110 V~	2 NO + 2 NC
1	4 161 36	18.5 kW	230 V~	2 NO + 2 NC
1	4 161 39	18.5 kW	415 V~	2 NO + 2 NC

Pack	Cat.Nos	CTX³ 65		
		With integrated auxiliary contacts		
		50 A (AC3) - 70 A (AC1)		
		3-phase motor 400/415 V	Control Voltage	Integrated auxiliary contacts
1	4 161 40	22 kW	24 V~	2 NO + 2 NC
1	4 161 41	22 kW	24 V=	2 NO + 2 NC
1	4 161 44	22 kW	110 V~	2 NO + 2 NC
1	4 161 46	22 kW	230 V~	2 NO + 2 NC
1	4 161 49	22 kW	415 V~	2 NO + 2 NC
		65 A (AC3) - 100 A (AC1)		
1	4 161 60	30 kW	24 V~	2 NO + 2 NC
1	4 161 61	30 kW	24 V=	2 NO + 2 NC
1	4 161 64	30 kW	110 V~	2 NO + 2 NC
1	4 161 66	30 kW	230 V~	2 NO + 2 NC
1	4 161 69	30 kW	415 V~	2 NO + 2 NC

Pack	Cat.Nos	CTX³ 100		
		With integrated auxiliary contacts		
		75 A (AC3) - 110 A (AC1)		
		3-phase motor 400/415 V	Control Voltage	Integrated auxiliary contacts
1	4 161 80	37 kW	24 V~	2 NO + 2 NC
1	4 161 81	37 kW	24 V=	2 NO + 2 NC
1	4 161 84	37 kW	110 V~	2 NO + 2 NC
1	4 161 86	37 kW	230 V~	2 NO + 2 NC
1	4 161 89	37 kW	415 V~	2 NO + 2 NC
		85 A (AC3) - 135 A (AC1)		
1	4 162 00	45 kW	24 V~	2 NO + 2 NC
1	4 162 01	45 kW	24 V=	2 NO + 2 NC
1	4 162 04	45 kW	110 V~	2 NO + 2 NC
1	4 162 06	45 kW	230 V~	2 NO + 2 NC
1	4 162 09	45 kW	415 V~	2 NO + 2 NC
		100 A (AC3) - 160 A (AC1)		
1	4 162 20	55 kW	24 V~	2 NO + 2 NC
1	4 162 21	55 kW	24 V=	2 NO + 2 NC
1	4 162 24	55 kW	110 V~	2 NO + 2 NC
1	4 162 26	55 kW	230 V~	2 NO + 2 NC
1	4 162 29	55 kW	415 V~	2 NO + 2 NC

For dimensions, wiring capacity and coordination with circuit breakers **see e-catalogue**



















Add-on auxiliary contact blocks **p. 186**



3-pole contactors CTX³ and thermal overload relays RTX³

technical characteristics

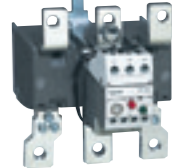
																												
Contactor		CTX ³ mini	CTX ³ 22	CTX ³ 40	CTX ³ 65	CTX ³ 100	CTX ³ 150	CTX ³ 225	CTX ³ 400	CTX ³ 800																		
Size		-	2	3	4	5	6	7	8	9																		
Terminals type		screw	screw	screw	screw or cage	screw or cage	screw or cage	screw	screw	screw																		
Rated operational voltage, U _e		690 V	690 V	690 V	690 V	690 V	690 V	690 V	690 V	690 V																		
Rated insulation voltage, U _i		690 V	690 V	1000 V	1000 V	1000 V	1000 V	1000 V	1000 V	1000 V																		
Rated frequency		50/60 Hz	50/60 Hz	50/60 Hz	50/60 Hz	50/60 Hz	50/60 Hz	50/60 Hz	50/60 Hz	50/60 Hz																		
Rated impulse withstand voltage, U _{imp}		6 kV	6 kV	8 kV	8 kV	8 kV	8 kV	8 kV	8 kV	8 kV																		
Max. operating rate in operation cycle per hour (AC-3)		1800	1800	1800	1800	1800	1200	1200	1200	1200																		
Durability in millions of operations	Mechanical	12	15	12	12	12	5	5	5	2.5																		
	Electrical	1	2.5	2	2	2	1	1	1	0.5																		
Type		6 A	9 A	12 A	16 A	9 A	12 A	18 A	22 A	32 A	40 A	50 A	65 A	75 A	85 A	100 A	130 A	150 A	185 A	225 A	265 A	330 A	400 A	500 A	630 A	800 A		
Current and power	AC-1	Thermal current (A)	20	20	20	20	25	25	40	40	50	60	70	100	110	135	160	160	210	230	275	300	350	450	580	660	900	
		200/240 V (kW)	1.5	2.2	3	4	2.5	3.5	4.5	5.5	7.5	11	15	18.5	22	25	30	37	45	55	75	80	90	125	147	190	220	
	AC-3	(A)	7	9	12	15	11	13	18	22	32	40	55	65	75	85	105	130	150	185	225	265	330	400	500	630	800	
		380/440 V (kW)	2.2	4	5.5	7.5	4	5.5	7.5	11	15	18.5	22	30	37	45	55	60	75	90	132	147	160	200	265	330	440	
	500/550 V (kW)	(A)	3	3.7	4	5.5	4	7.5	7.5	15	18.5	22	30	33	37	45	55	60	70	110	132	147	160	225	265	330	500	
		690 V (kW)	3	4	4	4	4	7.5	7.5	15	18.5	22	30	33	37	45	55	55	55	110	140	160	200	250	300	400	500	
	1000 V (kW)	(A)	4	5	5	5	5	9	9	18	20	23	28	35	42	45	65	60	60	120	150	185	225	300	380	420	630	
		(A)	-	-	-	-	-	-	-	-	22	22	30	30	37	27	37	75	75	132	132	147	147	147	220	220	220	
	UL rating 50/60 Hz	Continuous current (A)		20	20	20	20	25	25	40	40	50	60	70	100	110	135	160	160	210	230	275	300	350	450	580	660	900
		Single phase	110/220 V (HP)	1/2	1/2	1	-	0.5	0.75	1	2	2	3	3	5	5	7.5	10	10	15	15	15	15	-	-	-	-	-
220/240 V (HP)			1	1.5	2	-	1.5	2	3	3	5	7.5	10	15	15	15	20	20	25	30	40	40	-	-	-	-	-	
Three phase		200/208 V (HP)	-	-	-	-	2	3	5	7.5	7.5	15	20	25	25	30	30	40	40	60	60	75	100	125	150	200	200	
		220/240 V (HP)	1.5	3	3	-	3	5	7.5	10	10	15	25	30	30	40	40	40	50	60	75	100	125	150	200	250	300	
		440/480 V (HP)	3	5	7.5	-	5	7.5	10	15	20	30	40	50	50	60	75	75	100	125	150	200	250	300	400	500	600	
		550/600 V (HP)	3	5	7.5	-	7.5	10	15	20	25	30	50	60	60	75	75	75	75	125	150	200	250	300	400	500	600	
NEMA size		00	00	00	0	00	00	0	1	1	1	2	2	2	3	3	3	4	4	4	5	5	5	6	6	7		
Weight and size	AC control	Weight (kg)	0.17				0.34				0.4		0.9			1.6			2.4		5.4		9.2			22.4		
		Size (W x H x D) (mm)	45 x 58 x 57				45 x 73.5 x 87.4				45 x 83 x 90		55 x 106 x 119			70 x 140 x 135.8			95 x 158 x 130.3		138 x 203 x 185.1		163 x 243 x 204.4			285 x 312 x 245.3		
	DC control	Weight (kg)	0.23				0.41				0.6		1.2			2.6			2.4		5.4		9.2			22.4		
		Size (W x H x D) (mm)	45 x 58 x 69				45 x 73.5 x 103.6				45 x 83 x 117.1		55 x 106 x 146.4			70 x 140 x 172.3			95 x 158 x 130.3		138 x 203 x 185.1		163 x 243 x 204.4			285 x 312 x 245.3		
Integrated auxiliary contacts		1 NO or 1 NC				1 NO + 1 NC				2 NO + 2 NC		2 NO + 2 NC			2 NO + 2 NC			2 NO + 2 NC		2 NO + 2 NC		2 NO + 2 NC		2 NO + 2 NC				
Add on auxiliary block	Side mounting	Yes				Yes				Yes		Yes			Yes			Yes		Yes		Yes		Yes				
	Front mounting	Yes				Yes				Yes		Yes			Yes			Yes		No		No		No				
Thermal overload relay		RTX ³ mini	RTX ³ 40	RTX ³ 40	RTX ³ 65	RTX ³ 100	RTX ³ 150	RTX ³ 225	RTX ³ 400	RTX ³ 800																		
																												
Standard RTX ³		-	screw	screw	screw	screw	screw	-	-	-																		
Differential RTX ³		screw	screw	screw	cage	cage	screw	screw	screw	screw																		
Rated operational voltage, U _e		690 V	690 V	690 V	690 V	690 V	690 V	690 V	690 V	690 V																		
Rated insulation voltage, U _i		690 V	690 V	690 V	690 V	690 V	690 V	690 V	690 V	690 V																		
Rated impulse withstand voltage, U _{imp}		6 kV	6 kV	6 kV	6 kV	6 kV	6 kV	6 kV	6 kV	6 kV																		
Trip class		10 A	10 A	10 A	10 A	10 A	10 A	10 A	10 A	10 A																		
Setting		0.1 to 16 A	0.1 to 40 A	0.1 to 40 A	9 to 65 A	18 to 100 A	45 to 150 A	65 to 240 A	85 to 400 A	200 to 800 A																		
Weight and size	Weight (kg)	0.1	0.17	0.17	0.31/0.33	0.48/0.5	0.67	2.5	2.6	11.5																		
	Size (W x H x D) (mm)	45 x 73 x 63	45 x 75 x 90	45 x 75 x 90	55 x 81 x 100	70 x 97 x 110	95 x 109 x 113	147 x 141 x 184	151 x 171 x 198	360 x 530 x 212																		

3-pole contactors CTX³

dimensions

CTX³ 22

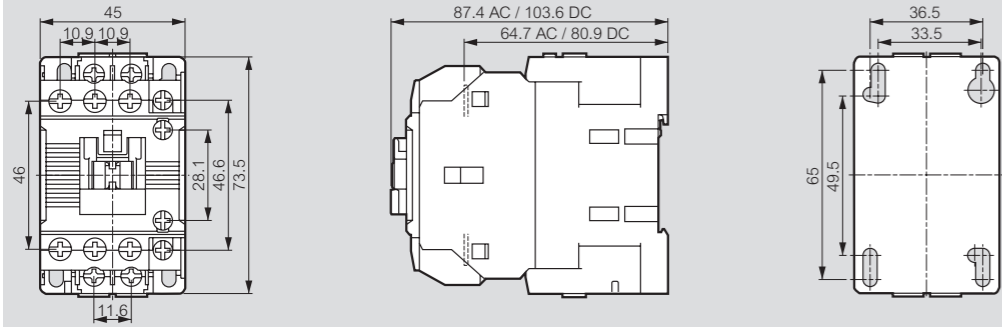

CTX³ 150

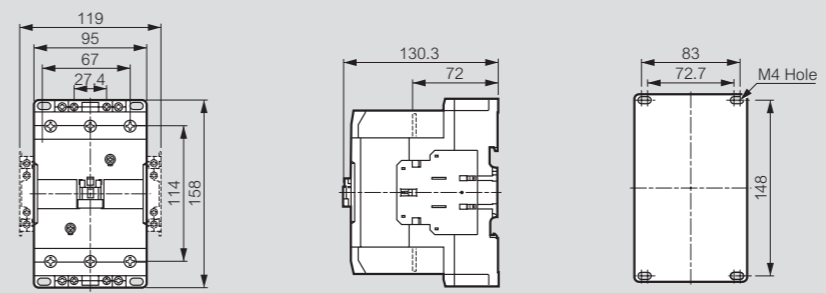

CTX³ 40

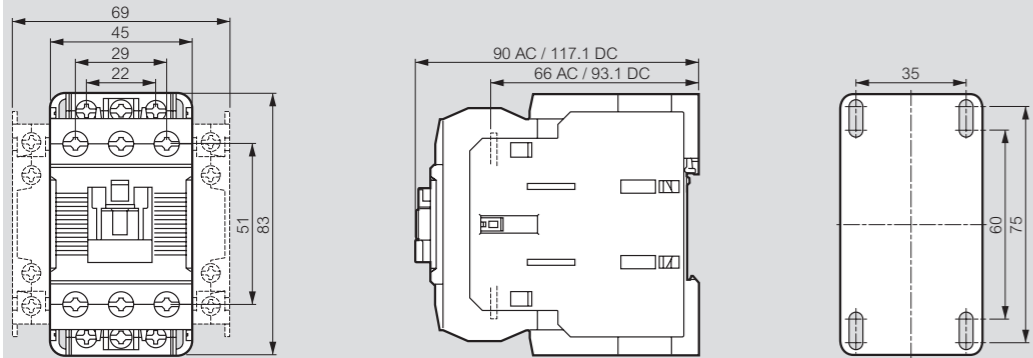

CTX³ 225

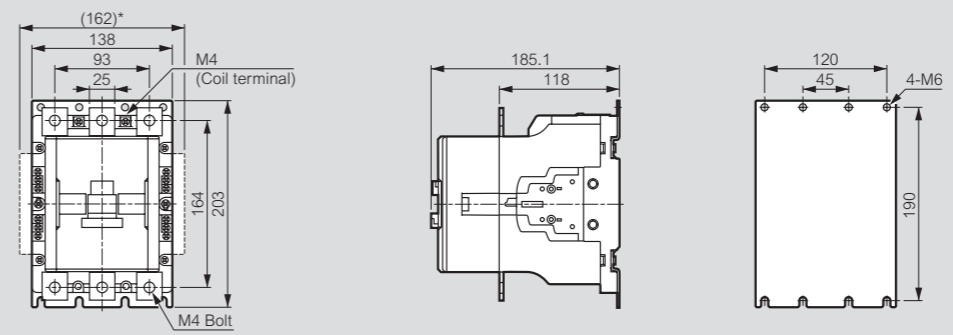

CTX³ 65

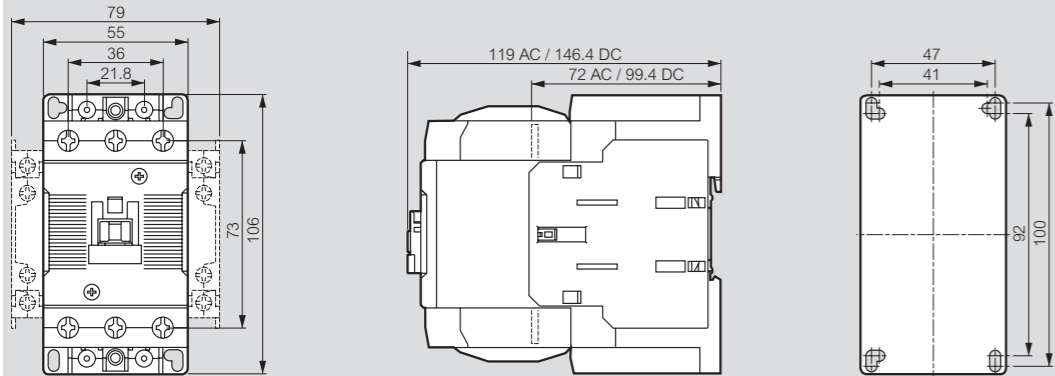

CTX³ 400

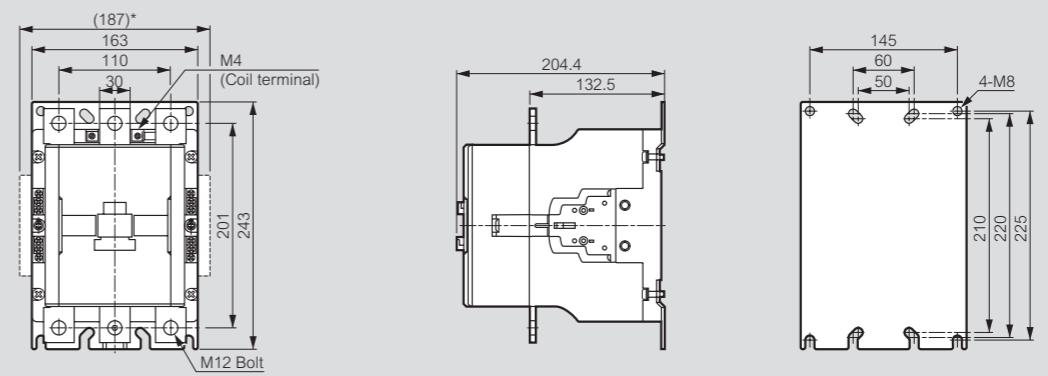

CTX³ 100

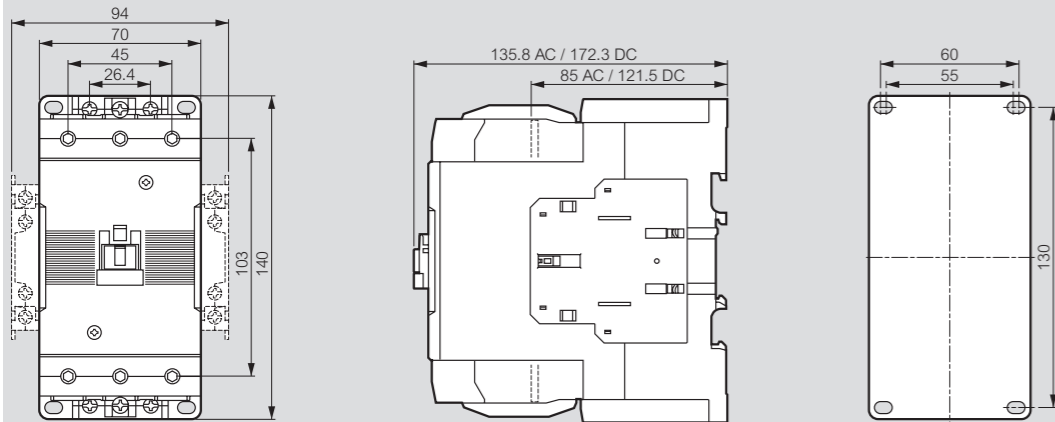

CTX³ 800

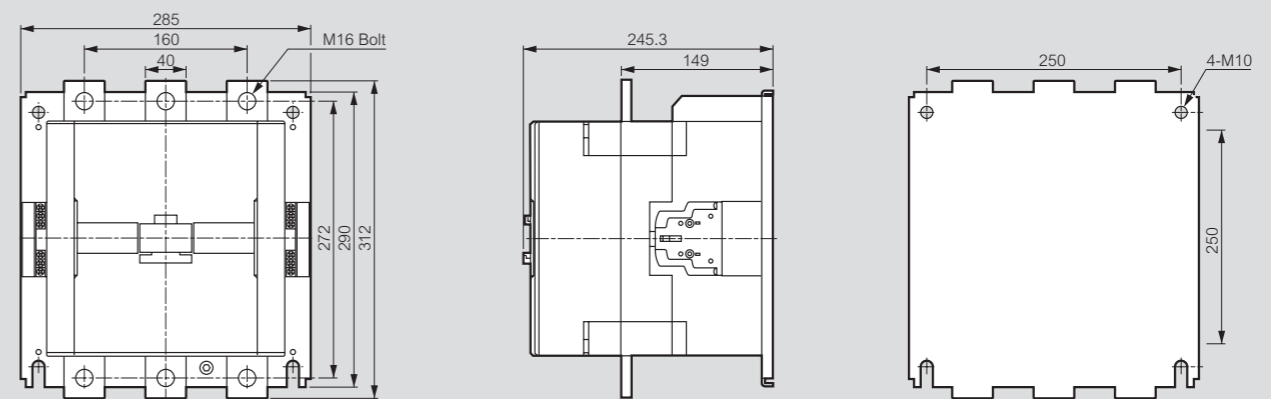

Industrial Contactors CTX³ 3P 9A - 150A

Cat. N°(s) : 4 160 80..84/86/88..94/96/98..99/4 161 00..04/ 4 161 06/08..14/16/18..24/26/28..34/36/38..44/46/48..54/56/ 4 161 58..64/66/68..74/76/78..84/86/88..94/96/98..99/
4 162 00..04/06/08..14/16/18..24/26/28..34/36/38..43/46/
4 162 49..53/56/59..63/66/69..73/76/79



CONTENTS	PAGES
1. Description - Use	1
2. Range	1
3. Overall dimensions.....	1
4. Installation - Connection.....	2
5. General characteristics	4
6. Conformities and approvals.....	35
7. Auxiliaries and accessories	35

1. DESCRIPTION - USE

. Remote control of a load by the mean of a switch.

Symbol:

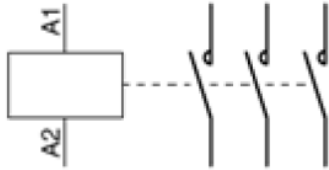

Technology :

. Electromagnetic contactor.

2. RANGE

Number of Poles:

. Triple pole (3P).

Rated current Ie:

. 9A, 12A, 18A, 22A, 32A, 40A, 50A, 65A, 75A, 85A, 100A, 130A, 150A.

Rated Voltage / Frequency:

. 690 V, 50 / 60 Hz with standard tolerances.

Rated control circuit voltage Uc:

- . 24 [V~].
- . 24 [V=].
- . 48 [V~].
- . 48 [V=].
- . 110 [V~].
- . 230 [V~].
- . 380 [V~].
- . 415 [V~].

3. OVERALL DIMENSIONS

CTX³ 22:

. CTX³ Contactor 3P 9A / 12A / 18A / 22A

- Type AC and Type DC: 1NO + 1NC Auxiliary contacts

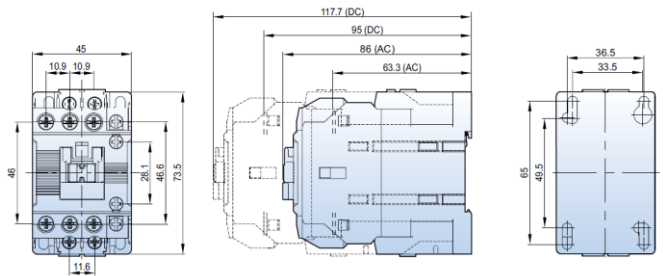

CTX³ 40:

. CTX³ Contactor 3P 32A / 40A

- Type AC and Type DC: 2NO + 2NC Auxiliary contacts

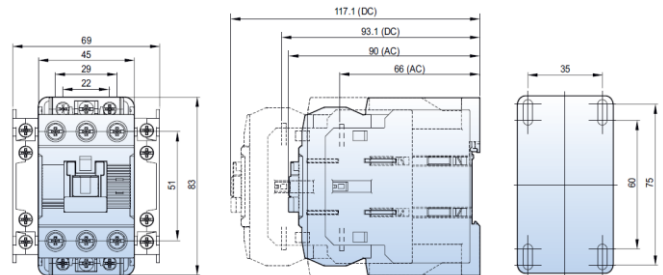

Industrial Contactors

CTX³ 3P 9A - 150A

Cat. N°(s) : 4 160 80..84/86/88..94/96/98..99/4 161 00..04/ 4 161 06/08..14/16/18..24/26/28..34/36/38..44/46/48..54/56/ 4 161 58..64/66/68..74/76/78..84/86/88..94/96/98..99/ 4 162 00..04/06/08..14/16/18..24/26/28..34/36/38..43/46/ 4 162 49..53/56/59..63/66/69..73/76/79

3. OVERALL DIMENSIONS (continued)

CTX³ 65:

- . CTX³ Contactor 3P 50A / 65A
- Type AC and Type DC: 2NO + 2NC Auxiliary contacts

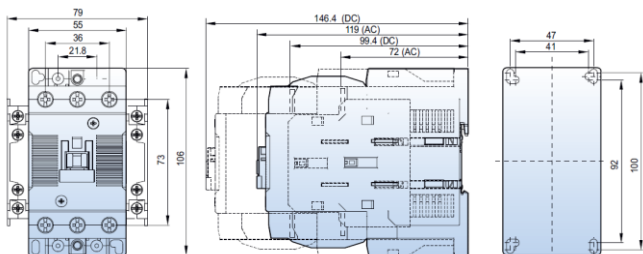

CTX³ 100:

- . CTX³ Contactor 3P 75A / 85A / 100A
- Type AC and Type DC: 2NO + 2NC Auxiliary contacts

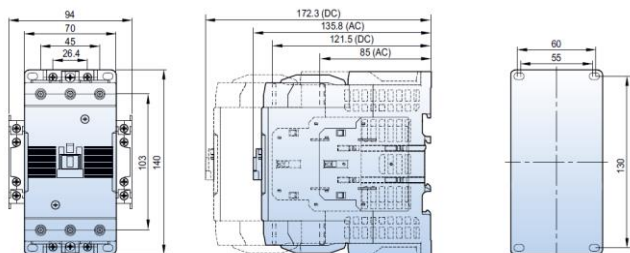

CTX³ 150:

- . CTX³ Contactor 3P 130A / 150A
- Type AC and Type DC: 2NO + 2NC Auxiliary contacts

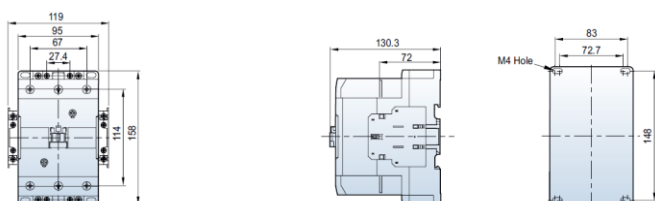

4. INSTALLATION - CONNECTION

Fixing:

- . Mounting on DIN rail or on plate up to 150A.
- . 35mm DIN rail for CTX³ 22~CTX³ 100.
- . 75mm DIN rail for CTX³ 150.

Operating position:

- . ± 30 [°] possible, in relation to normal vertical mounting plane.

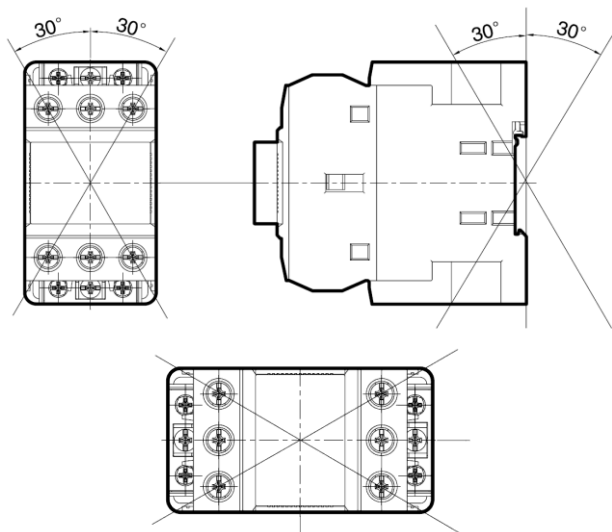

- . In lateral position (+/- 90°) : derating of number of operations per hour by 20%.

Supply:

- . Either from the top or the bottom.













Industrial Contactors











CTX³ 3P 9A - 150A

Cat. N°(s) : 4 160 80..84/86/88..94/96/98..99/4 161 00..04/ 4 161 06/08..14/16/18..24/26/28..34/36/38..44/46/48..54/56/ 4 161 58..64/66/68..74/76/78..84/86/88..94/96/98..99/ 4 162 00..04/06/08..14/16/18..24/26/28..34/36/38..43/46/ 4 162 49..53/56/59..63/66/69..73/76/79

4. INSTALLATION - CONNECTION (continued)

Wire size and tightening torque:

Frame	Wire type	Main Terminal Size								Torque		
			(AWG / mm ²)						mm(max)	[lb-in]	[Nm]	[kgf·cm]
CTX ³ 22 - 9A		M4	18~10 / 1~6		18~10 / 1~6		18~10 / 1~6		9.6	20	2.25	23
CTX ³ 22 - 12A			18~10 / 1~6		16~10 / 1~6		16~10 / 1~6					
CTX ³ 22 - 18A			18~10 / 1~6		16~8 / 1.5~10		16~8 / 1.5~10					
CTX ³ 22 - 22A			18~10 / 1~6		14~8 / 2.5~10		14~8 / 2.5~10					
CTX ³ 40 - 32A		M5	18~10 / 1~6		12~8 / 2.5~10		12~8 / 2.5~10		12.8	20	2.25	23
CTX ³ 40 - 40A			18~10 / 1~6		8~6 / 10~16		8~6 / 10~16					
CTX ³ 65 - 50A		M6	-		10~4 / 6~25		10~4 / 6~25		14	35	4	41
CTX ³ 65 - 65A			-		8~3 / 10~35		8~3 / 10~35					
CTX ³ 100 - 75A		M8	-		8~2 / 10~35		8~2 / 10~35		17	45	5.1	52
CTX ³ 100 - 85A			-		8~1/0 / 10~50		8~1/0 / 10~50					
CTX ³ 100 - 100A			-		8~2/0 / 10~70		8~2/0 / 10~70					
CTX ³ 150 - 130A		M8	-		3~2/0 / 35~70		3~2/0 / 35~70		24.5	80	9.1	93
CTX ³ 150 - 150A			-		3~4/0 / 35~95		3~4/0 / 35~95					
CTX ³ 22~150 Aux./Coil		M4	20~14 / 0.5~2.5		18~12 / 0.75~2.5		18~12 / 0.75~2.5		7.6	15	1.75	18

FRAME	WIRE TYPE								TORQUE		
		(AWG / mm ²)						mm (Max)	[lb-in]	[Nm]	
CTX ³ 65		0.75~35 / 18~2	0.75~25 / 18~4	0.75~35 / 18~2	0.75~25 / 18~4	0.75~25 / 18~4	0.75~16 / 18~6	---	35	4	
CTX ³ 100		2.5~70 / 12~2	2.5~50 / 12~1	2.5~70 / 12~2	2.5~50 / 12~1	2.5~50 / 12~2	2.5~35 / 10~2	---	45	5.1	
CTX ³ 150		2.5~70 / 12~2	2.5~50 / 12~1	35~95 / 3~4	35~95 / 3~4	35~95 / 3~4	35~95 / 3~4	---	80	9.1	

Type of conductors:

. Conductor type = 65/75°C Cu-wire only.

Tools required:

- . Pozidriv N°2 screwdriver recommended.
- . Flat screwdriver Ø5 to Ø6 [mm] Maximum.
- . Hexagonal key to CTX³ 100 and CTX³ 150 only.
- . Flat spanner for M6 bolt (CTX³ 65).
- . Flat spanner for M8 bolt (CTX³ 100 and CTX³ 150).

Industrial Contactors

CTX³ 3P 9A - 150A

Cat. N°(s) : 4 160 80..84/86/88..94/96/98..99/4 161 00..04/ 4 161 06/08..14/16/18..24/26/28..34/36/38..44/46/48..54/56/ 4 161 58..64/66/68..74/76/78..84/86/88..94/96/98..99/ 4 162 00..04/06/08..14/16/18..24/26/28..34/36/38..43/46/ 4 162 49..53/56/59..63/66/69..73/76/79

5. GENERAL CHARACTERISTICS

Front side:

. By dark grey laser or pad printing:

- Brand: Legrand
- Range: CTX + frame
- Rated current (in A)
- Marking power terminals
- Marking auxiliary terminals when required

CTX³ 22: (Example of marking)

. CTX³ Contactor 3P 9A / 12A / 18A / 22A

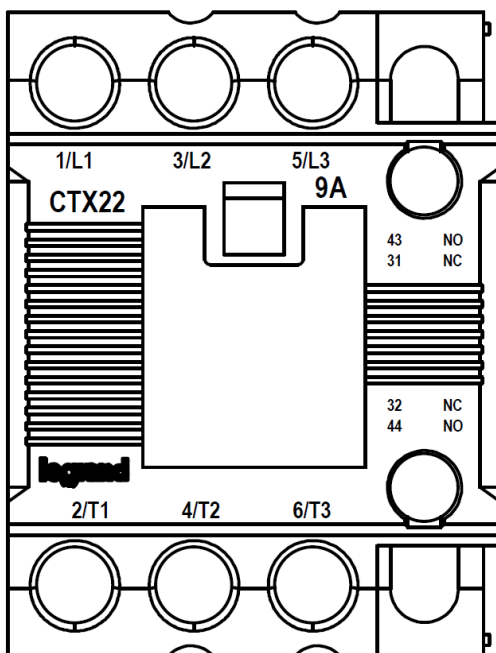

Left side:

. By identification label (referring to IEC standard)

legrand® CTX ³ 150A				
Uc	24V	48V	100/240V	415V
Us	20.4-26.4V	40.8V-52.8V	AC 85-254V	323-484V
AC Ref	4 162 70	4 162 72	4 162 76	4 162 79
DC Ref	4 162 71	4 162 73	4 162 76	
AC3	IEC/EN 60947	VDE0660	BS5424	GB14048.4
V AC	240	440	550	690
kW	45	75	70	65
A	150	150	100	60
	1PH		3PH	
V AC	120	240	208	240 480 600
UL HP	15	25	40	50 100 100
AC1 = Ith = 210A	Ui = 1,000V		Uimp = 8kV	
This device meets/obeys: NEMA/EMC requirements Aux. Cont. - A600 P600				
Continuous current : 210A				
When protected by 200A time delay fuses.				
Short circuit 10kA RMS Sym., 600V Max. Break all lines.				
AWG 3-4/0 75°C Cu Standard wire.				
Torque : 80 lb.in. 79611641048				

5. GENERAL CHARACTERISTICS (continued)

Upper side: when applicable

. By dark grey laser or pad printing:

- Control voltage (Uc)
- Frequency (f)
- Terminals identification

Lower side: when applicable

. By dark grey laser or pad printing:

- Control voltage (Uc)
- Frequency (f)
- Terminals identification

Rated operational voltage:

. Ue = 690 [V] for all products.

Frequency limit:

. 25/400 [Hz].

Degree of pollution:

. 3, in accordance with IEC / EN 60 947-4-1.

Rated impulse voltage and rated insulation voltage:

Type of products	Rated impulse voltage (Uimp)	Rated insulation voltage (Ui)
CTX ³ 22	6 [kV]	690 [V]
CTX ³ 40	8 [kV]	1 000 [V]
CTX ³ 65	8 [kV]	1 000 [V]
CTX ³ 100	8 [kV]	1 000 [V]
CTX ³ 150	8 [kV]	1 000 [V]

Overvoltage category:

. Category III.

Mechanical and electrical endurance:

Type of products	Mechanical endurance (in millions of operations)	Electrical endurance (in millions of operations)	Maxi operating rate in operating cycles per hour (AC3)
CTX ³ 22	15	2.5	1800
CTX ³ 40	12	2	1800
CTX ³ 65	12	2	1200
CTX ³ 100	12	2	1200
CTX ³ 150	5	1	1200

. In lateral position, refer to the instructions of the paragraph "Operating position" of the technical data sheet.

Example : For the CTX³ 22 40 [A], 1800 becomes 1440 (derating of 20% Maximum number of operations per hours).

Industrial Contactors

CTX³ 3P 9A - 150A

Cat. N°(s) : 4 160 80..84/86/88..94/96/98..99/4 161 00..04/ 4 161 06/08..14/16/18..24/26/28..34/36/38..44/46/48..54/56/ 4 161 58..64/66/68..74/76/78..84/86/88..94/96/98..99/ 4 162 00..04/06/08..14/16/18..24/26/28..34/36/38..43/46/ 4 162 49..53/56/59..63/66/69..73/76/79

5. GENERAL CHARACTERISTICS *(continued)*

Weight:

Type of products	AC Control	DC Control
CTX ³ 22	0.34 [kg]	0.51 [kg]
CTX ³ 40	0.4 [kg]	0.6 [kg]
CTX ³ 65	0.9 [kg]	1.2 [kg]
CTX ³ 100	1.6 [kg]	2.6 [kg]
CTX ³ 150	2.4 [kg]	

Ambient operating temperature:

. Min. = -5°C. Max. = +55°C (AC type) / +40°C (DC Type).
(-20% derating up to +65°C, -30% derating up to +70°C)

Derating of products depending on the ambient temperature:

		Ambient temperature			
		≤ 40 [°C] ≤ 104 [°F]	≤ 55 [°C] ≤ 131 [°F]	≤ 65 [°C] ≤ 149 [°F]	≤ 70 [°C] ≤ 158 [°F]
Operational current (AC1) [A]	CTX ³ 3P 22 - 9A	25	25	20	17
	CTX ³ 3P 22 - 12A	25	25	20	17
	CTX ³ 3P 22 - 18A	40	40	32	28
	CTX ³ 3P 22 - 22A	40	40	32	28
	CTX ³ 3P 40 - 32A	50	50	40	35
	CTX ³ 3P 40 - 40A	60	60	50	42
	CTX ³ 3P 65 - 50A	70	70	56	49
	CTX ³ 3P 65 - 65A	100	100	80	70
	CTX ³ 3P 100 - 75A	110	110	88	77
	CTX ³ 3P 100 - 85A	135	135	108	94
	CTX ³ 3P 100 - 100A	160	160	128	112
	CTX ³ 3P 150 - 130A	160	160	130	110
	CTX ³ 3P 150 - 150A	210	210	170	145

Ambient storage temperature:

. Min. = -50°C. Max. = +80°C.

Degree of protection: (In accordance with IEC 60 529 standard)

. IP20.

Flame resistance:

. Conforming to UL = V0.
. Conforming to IEC 695-2-1 = 960 [°C].

Industrial Contactors

CTX³ 3P 9A - 150A

Cat. N°(s) : 4 160 80..84/86/88..94/96/98..99/4 161 00..04/ 4 161 06/08..14/16/18..24/26/28..34/36/38..44/46/48..54/56/ 4 161 58..64/66/68..74/76/78..84/86/88..94/96/98..99/ 4 162 00..04/06/08..14/16/18..24/26/28..34/36/38..43/46/ 4 162 49..53/56/59..63/66/69..73/76/79

5. GENERAL CHARACTERISTICS *(continued)*

Maximum operating altitude:

. 3000 [m].

High altitude application:

. Rated compensation coefficient at altitudes of more than 1000[m]:

Type	ANSI C37 30-1971			BS2692 PT1-1971/IEC Pub.282-1-1985			
	Rated insulation voltage	Rated current flow of current	Surrounding temperature	Voltage resistance test voltage	Rated insulation voltage	Rated current flow current	Temperature rise
1000	1.00	1.00	1.00	1.0	1.0	1.0	1.0
1200	0.98	0.995	0.992	↑ proportional	↑ proportional	↑ proportional	↑ proportional
1500	0.95	0.99	0.980	1.05	0.95	0.99	0.98
1800	0.92	0.985	0.968	↑ proportional	↑ proportional	↑ proportional	↑ proportional
2100	0.89	0.98	0.956				
2400	0.86	0.97	0.944				
2700	0.83	0.965	0.932				
3000	0.80	0.96	0.920				
3600	0.75	0.95	0.896	1.25	0.80	0.96	0.92
4200	0.70	0.935	0.872	/	/	/	/
4800	0.65	0.925	0.848				
5400	0.61	0.91	0.824				
6000	0.56	0.90	0.800				

Shock resistance: (1/2 sine wave = 11 [ms])

- . Opened = 8 [g].
- . Closed = 10 [g].

Vibration resistance: (Conforming to IEC68-2-6; 5...300 [Hz])

- . Opened = 2 [g].
- . Closed = 4 [g].

Industrial Contactors

CTX³ 3P 9A - 150A

Cat. N°(s) : 4 160 80..84/86/88..94/96/98..99/4 161 00..04/ 4 161 06/08..14/16/18..24/26/28..34/36/38..44/46/48..54/56/ 4 161 58..64/66/68..74/76/78..84/86/88..94/96/98..99/ 4 162 00..04/06/08..14/16/18..24/26/28..34/36/38..43/46/ 4 162 49..53/56/59..63/66/69..73/76/79

5. GENERAL CHARACTERISTICS (continued)

Control coil characteristics:

FRAME SIZE	CTX ³ 3P 22	CTX ³ 3P 40	CTX ³ 3P 65	CTX ³ 3P 100	CTX ³ 3P 150	
Type	9A 12A 18A 22A	32A 40A	50A 65A	75A 85A 100A	130A 150A	
AC coil						
Control voltage [Uc]					24, 48	
50/60Hz [V]	24, 48, 110, 230, 380, 415V				100~240, 400~440V	
Voltage limit [Uc]	85 ~110% (50Hz)					
Pick-up	85 ~110% (60Hz)					
Drop-out	30 ~ 60%					
Coil consumption at 20°C						
AC 230V	Inrush [VA]	58/56	53/50	110/104	229/216	108/104
50/60Hz	Holding [VA]	9/6	12/9	13/10	17/13	18/21
Heat dissipation [W]		2.1/1.5	2.7/2.2	2.8/2.4	5.4/4.7	2.7/3.6
Operating time						
	Closing [ms]	12...22	12...22	12...22	15...30	20...40
	Opening [ms]	4...19	4...19	4...19	10...30	60...70
DC coil						
Control voltage [Uc]	24, 48V				24, 48, 100, 220V	
Voltage limit [Uc]	70 ~ 110%					
Pick-up	70 ~ 110%					
Drop-out	10 ~ 30%					
Coil consumption at 20°C						
DC 110V	Inrush [W]	9	7	9	18	213
	Holding [W]	9	7	9	18	7.5
Time constant (L/R) [ms]		28	28	65	75	-
Operating time						
	Closing [ms]	35...50	50...65	50...65	100...120	70...80
	Opening [ms]	4...19	4...19	4...19	10...25	60...70

Lifetime of the coil supplied permanently:

. No limit.

Industrial Contactors

CTX³ 3P 9A - 150A

Cat. N°(s) : 4 160 80..84/86/88..94/96/98..99/4 161 00..04/ 4 161 06/08..14/16/18..24/26/28..34/36/38..44/46/48..54/56/ 4 161 58..64/66/68..74/76/78..84/86/88..94/96/98..99/ 4 162 00..04/06/08..14/16/18..24/26/28..34/36/38..43/46/ 4 162 49..53/56/59..63/66/69..73/76/79

5. GENERAL CHARACTERISTICS *(continued)*

Rating: In accordance with IEC 60 947 and IEC 60 947-4-1

. For Contactor CTX³ 3P 22~150

- Rated short-time withstand current, (I_{cw})
- Rated making capacity - AC3
- Rated breaking capacity - AC3

Contactor type			CTX ³ 3P 22 - 9[A]	CTX ³ 3P 22 - 12[A]	CTX ³ 3P 22 - 18[A]	CTX ³ 3P 22 - 22[A]	CTX ³ 3P 40 - 32[A]	CTX ³ 3P 40 - 40[A]
I_{cw} Rated short-time withstand current (IEC 60 947)	1 [s]	[A]	250	280	300	400	600	600
	10 [s]	[A]	110	120	154	186	260	260
	30 [s]	[A]	70	80	100	130	160	160
	1 [min]	[A]	61	61	84	90	100	100
	3 [min]	[A]	45	50	60	60	70	70
	10 [min]	[A]	30	30	40	50	55	55
	≥ 15 [min]	[A]	26	28	40	45	50	50

Contactor type		CTX ³ 3P 22 - 9[A]	CTX ³ 3P 22 - 12[A]	CTX ³ 3P 22 - 18[A]	CTX ³ 3P 22 - 22[A]	CTX ³ 3P 40 - 32[A]	CTX ³ 3P 40 - 40[A]
According to IEC 60 947-4-1 (AC3)	Rated making capacity	90	120	180	220	320	400
	Rated breaking capacity	72	96	144	176	256	320

Contactor type			CTX ³ 3P 65 - 50[A]	CTX ³ 3P 65 - 65[A]	CTX ³ 3P 100 - 75[A]	CTX ³ 3P 100 - 85[A]	CTX ³ 3P 100 - 100[A]	CTX ³ 3P 150 - 130[A]	CTX ³ 3P 150 - 150[A]
I_{cw} Rated short-time withstand current (IEC 60 947)	1 [s]	[A]	1000	1050	1100	1200	1320	1350	1800
	10 [s]	[A]	550	700	750	800	900	950	1200
	30 [s]	[A]	330	380	400	450	500	700	800
	1 [min]	[A]	250	270	300	350	400	550	600
	3 [min]	[A]	150	200	220	270	270	350	450
	10 [min]	[A]	90	120	140	170	180	200	300
	≥ 15 [min]	[A]	87	100	114	150	160	175	280

Contactor type		CTX ³ 3P 65 - 50[A]	CTX ³ 3P 65 - 65[A]	CTX ³ 3P 100 - 75[A]	CTX ³ 3P 100 - 85[A]	CTX ³ 3P 100 - 100[A]	CTX ³ 3P 150 - 130[A]	CTX ³ 3P 150 - 150[A]
According to IEC 60 947-4-1 (AC3)	Rated making capacity	500	650	750	850	1050	1200	1500
	Rated breaking capacity	400	520	600	650	840	960	1200

Industrial Contactors

CTX³ 3P 9A - 150A

Cat. N°(s) : 4 160 80..84/86/88..94/96/98..99/4 161 00..04/ 4 161 06/08..14/16/18..24/26/28..34/36/38..44/46/48..54/56/ 4 161 58..64/66/68..74/76/78..84/86/88..94/96/98..99/ 4 162 00..04/06/08..14/16/18..24/26/28..34/36/38..43/46/ 4 162 49..53/56/59..63/66/69..73/76/79

5. GENERAL CHARACTERISTICS (continued)

Rating: In accordance with CE (IEC) and UL 508 certifications - $\theta \leq 55$ [°C]

. For Contactor CTX³ 3P 22

Contactor type			Rating = 9 [A]		Rating = 12 [A]		Rating = 18 [A]		Rating = 22 [A]	
			[kW]	[A]	[kW]	[A]	[kW]	[A]	[kW]	[A]
AC duty	AC3	200 / 240 [V]	2.5	11	3.5	13	4.5	18	5.5	22
		380 / 440 [V]	4	9	5.5	12	7.5	18	11	22
		500 / 550 [V]	4	7	7.5	12	7.5	13	15	20
		690 [V]	4	5	7.5	9	7.5	9	15	18
	AC4	200 / 240 [V]	1.5	8	2.2	11	3.7	16	3.7	18
		380 / 440 [V]	2.2	6	4	9	4	11	5.5	13
	AC1	lth	-	25	-	25	-	32	-	40
DC1 duty	2 pole in series	24 [V]	-	18	-	18	-	18	-	32
		48 [V]	-	17	-	17	-	17	-	30
		110 [V]	-	12	-	12	-	12	-	23
	3 pole in series	24 [V]	-	20	-	20	-	20	-	32
		48 [V]	-	20	-	20	-	20	-	32
		110 [V]	-	15	-	15	-	15	-	27
DC 2, 4 duty	2 pole in series	24 [V]	-	15	-	15	-	15	-	25
		48 [V]	-	12	-	12	-	12	-	20
		110 [V]	-	8	-	8	-	8	-	15
	3 pole in series	24 [V]	-	18	-	18	-	18	-	30
		48 [V]	-	15	-	15	-	15	-	30
		110 [V]	-	12	-	12	-	12	-	20

Contactor type			Rating = 9 [A]		Rating = 12 [A]		Rating = 18 [A]		Rating = 22 [A]	
			[hp]	[A]	[hp]	[A]	[hp]	[A]	[hp]	[A]
UL Rating (50 / 60 [Hz])	200 / 208 [V]	2	-	3	-	5	-	7.5	-	
	220 / 240 [V]	3	-	5	-	7.5	-	10	-	
	440 / 480 [V]	5	-	7.5	-	10	-	15	-	
	550 / 600 [V]	7.5	-	10	-	15	-	20	-	
	lth	-	25	-	25	-	40	-	40	

. Wiring diagrams

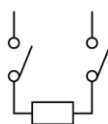

2pole for DC contact

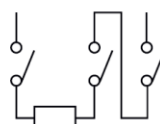

3pole for DC contact

Industrial Contactors

CTX³ 3P 9A - 150A

Cat. N°(s) : 4 160 80..84/86/88..94/96/98..99/4 161 00..04/ 4 161 06/08..14/16/18..24/26/28..34/36/38..44/46/48..54/56/ 4 161 58..64/66/68..74/76/78..84/86/88..94/96/98..99/ 4 162 00..04/06/08..14/16/18..24/26/28..34/36/38..43/46/ 4 162 49..53/56/59..63/66/69..73/76/79

5. GENERAL CHARACTERISTICS (continued)

Rating: In accordance with CE (IEC) and UL 508 certifications - $\theta \leq 55$ [°C] (continued)

. For Contactor CTX³ 3P 40

Contactor type			Rating = 32 [A]		Rating = 40 [A]	
			[kW]	[A]	[kW]	[A]
AC duty	AC3	200 / 240 [V]	7.5	32	11	40
		380 / 440 [V]	15	32	18.5	40
		500 / 550 [V]	18.5	28	22	32
		690 [V]	18.5	20	22	23
	AC4	200 / 240 [V]	4.5	20	5.5	25
		380 / 440 [V]	7.5	17	11	24
AC1	lth	-	50	-	60	
DC1 duty	2 pole in series	24 [V]	-	32	-	55
		48 [V]	-	30	-	55
		110 [V]	-	25	-	40
	3 pole in series	24 [V]	-	32	-	55
		48 [V]	-	32	-	55
		110 [V]	-	27	-	45
DC 2, 4 duty	2 pole in series	24 [V]	-	25	-	30
		48 [V]	-	20	-	25
		110 [V]	-	15	-	20
	3 pole in series	24 [V]	-	30	-	45
		48 [V]	-	30	-	40
		110 [V]	-	20	-	30

Contactor type		Rating = 32 [A]		Rating = 40 [A]	
		[hp]	[A]	[hp]	[A]
UL Rating (50 / 60 [Hz])	200 / 208 [V]	7.5	-	15	-
	220 / 240 [V]	10	-	15	-
	440 / 480 [V]	20	-	30	-
	550 / 600 [V]	25	-	30	-
	lth	-	50	-	60

. Wiring diagrams

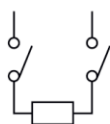

2pole for DC contact

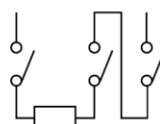

3pole for DC contact

Industrial Contactors

CTX³ 3P 9A - 150A

Cat. N°(s) : 4 160 80..84/86/88..94/96/98..99/4 161 00..04/ 4 161 06/08..14/16/18..24/26/28..34/36/38..44/46/48..54/56/ 4 161 58..64/66/68..74/76/78..84/86/88..94/96/98..99/ 4 162 00..04/06/08..14/16/18..24/26/28..34/36/38..43/46/ 4 162 49..53/56/59..63/66/69..73/76/79

5. GENERAL CHARACTERISTICS (continued)

Rating: In accordance with CE (IEC) and UL 508 certifications - $\theta \leq 55$ [°C] (continued)

. For Contactor CTX³ 3P 65

Contactor type			Rating = 50 [A]		Rating = 65 [A]	
			[kW]	[A]	[kW]	[A]
AC duty	AC3	200 / 240 [V]	15	55	18.5	65
		380 / 440 [V]	22	50	30	65
		500 / 550 [V]	30	43	33	60
		690 [V]	30	28	33	35
	AC4	200 / 240 [V]	7.5	35	11	50
		380 / 440 [V]	15	32	22	47
	AC1	lth	-	70	-	100
DC1 duty	2 pole in series	24 [V]	-	70	-	90
		48 [V]	-	70	-	90
		110 [V]	-	50	-	75
	3 pole in series	24 [V]	-	70	-	90
		48 [V]	-	70	-	90
		110 [V]	-	60	-	80
DC 2, 4 duty	2 pole in series	24 [V]	-	45	-	55
		48 [V]	-	40	-	45
		110 [V]	-	25	-	38
	3 pole in series	24 [V]	-	55	-	75
		48 [V]	-	50	-	65
		110 [V]	-	35	-	55

Contactor type		Rating = 50 [A]		Rating = 65 [A]	
		[hp]	[A]	[hp]	[A]
UL Rating (50 / 60 [Hz])	200 / 208 [V]	20	-	25	-
	220 / 240 [V]	25	-	30	-
	440 / 480 [V]	40	-	50	-
	550 / 600 [V]	50	-	60	-
	lth	-	70	-	100

. Wiring diagrams

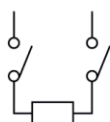

2pole for DC contact

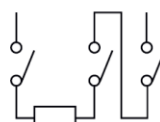

3pole for DC contact

Industrial Contactors

CTX³ 3P 9A - 150A

Cat. N°(s) : 4 160 80..84/86/88..94/96/98..99/4 161 00..04/ 4 161 06/08..14/16/18..24/26/28..34/36/38..44/46/48..54/56/ 4 161 58..64/66/68..74/76/78..84/86/88..94/96/98..99/ 4 162 00..04/06/08..14/16/18..24/26/28..34/36/38..43/46/ 4 162 49..53/56/59..63/66/69..73/76/79

5. GENERAL CHARACTERISTICS (continued)

Rating: In accordance with CE (IEC) and UL 508 certifications - $\theta \leq 55$ [°C] (continued)

. For Contactor CTX³ 3P 100

Contactor type		Rating = 75 [A]		Rating = 85 [A]		Rating = 100 [A]		
		[kW]	[A]	[kW]	[A]	[kW]	[A]	
AC duty	AC3	200 / 240 [V]	22	75	25	85	30	105
		380 / 440 [V]	37	75	45	85	55	105
		500 / 550 [V]	37	64	45	75	55	85
		690 [V]	37	42	45	45	45	65
	AC4	200 / 240 [V]	13	55	15	65	19	80
		380 / 440 [V]	25	52	30	62	37	75
AC1	lth	-	110	-	135	-	160	
DC1 duty	2 pole in series	24 [V]	-	90	-	100	-	100
		48 [V]	-	90	-	100	-	100
		110 [V]	-	75	-	80	-	80
	3 pole in series	24 [V]	-	90	-	100	-	100
		48 [V]	-	90	-	100	-	100
		110 [V]	-	80	-	85	-	85
DC 2, 4 duty	2 pole in series	24 [V]	-	55	-	60	-	60
		48 [V]	-	45	-	50	-	50
		110 [V]	-	38	-	40	-	40
	3 pole in series	24 [V]	-	75	-	80	-	80
		48 [V]	-	65	-	70	-	70
		110 [V]	-	55	-	60	-	60

Contactor type		Rating = 75 [A]		Rating = 85 [A]		Rating = 100 [A]	
		[hp]	[A]	[hp]	[A]	[hp]	[A]
UL Rating (50 / 60 [Hz])	200 / 208 [V]	25	-	30	-	30	-
	220 / 240 [V]	30	-	40	-	40	-
	440 / 480 [V]	50	-	60	-	75	-
	550 / 600 [V]	60	-	75	-	75	-
	lth	-	110	-	135	-	160

. Wiring diagrams

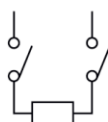

2pole for DC contact

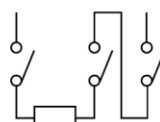

3pole for DC contact

Industrial Contactors

CTX³ 3P 9A - 150A

Cat. N°(s) : 4 160 80..84/86/88..94/96/98..99/4 161 00..04/ 4 161 06/08..14/16/18..24/26/28..34/36/38..44/46/48..54/56/ 4 161 58..64/66/68..74/76/78..84/86/88..94/96/98..99/ 4 162 00..04/06/08..14/16/18..24/26/28..34/36/38..43/46/ 4 162 49..53/56/59..63/66/69..73/76/79

5. GENERAL CHARACTERISTICS (continued)

Rating: In accordance with CE (IEC) and UL 508 certifications - $\theta \leq 55$ [°C] (continued)

. For Contactor CTX³ 3P 150

Contactor type			Rating = 130 [A]		Rating = 150 [A]	
			[kW]	[A]	[kW]	[A]
AC duty	AC3	200 / 240 [V]	37	130	45	150
		380 / 440 [V]	60	130	75	150
		500 / 550 [V]	60	90	70	100
		690 [V]	55	60	55	60
	AC4	200 / 240 [V]	22	93	30	120
		380 / 440 [V]	45	90	55	110
AC1	lth	-	160	-	210	
DC1 duty	2 pole in series	24 [V]	-	120	-	150
		48 [V]	-	100	-	120
		110 [V]	-	80	-	100
	3 pole in series	24 [V]	-	120	-	150
		48 [V]	-	120	-	150
		110 [V]	-	100	-	150
DC 2, 4 duty	2 pole in series	24 [V]	-	120	-	150
		48 [V]	-	60	-	100
		110 [V]	-	40	-	80
	3 pole in series	24 [V]	-	120	-	150
		48 [V]	-	90	-	130
		110 [V]	-	80	-	120

Contactor type		Rating = 130 [A]		Rating = 150 [A]	
		[hp]	[A]	[hp]	[A]
UL Rating (50 / 60 [Hz])	200 / 208 [V]	40	-	40	-
	220 / 240 [V]	40	-	50	-
	440 / 480 [V]	75	-	100	-
	550 / 600 [V]	75	-	75	-
	lth	-	160	-	210

. Wiring diagrams

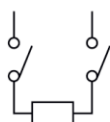

2pole for DC contact

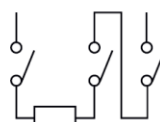

3pole for DC contact

Industrial Contactors

CTX³ 3P 9A - 150A

Cat. N°(s) : 4 160 80..84/86/88..94/96/98..99/4 161 00..04/ 4 161 06/08..14/16/18..24/26/28..34/36/38..44/46/48..54/56/ 4 161 58..64/66/68..74/76/78..84/86/88..94/96/98..99/ 4 162 00..04/06/08..14/16/18..24/26/28..34/36/38..43/46/ 4 162 49..53/56/59..63/66/69..73/76/79

5. GENERAL CHARACTERISTICS *(continued)*

Making and Breaking conditions according to application categories:

Category	Durability conditions						Occasional operation						
	Making			Breaking			Making			Breaking			
	I/I	U/U	Cos θ or L/R [ms]	I/I	U/U	Cos θ or L/R [ms]	I/I	U/U	Cos θ or L/R [ms]	I/I	U/U	Cos θ or L/R [ms]	
Magnetic contactors for AC circuit switching													
AC-1	1	1	0.95	1	1	0.95	1.5	1.05	0.8	1.5	1.05	0.8	
AC-2	2.5	1	0.65	2.5	1	0.65	4	1.05	0.65	4	1.05	0.65	
AC-3	$I \leq 17$ [A]	6	1	0.65	1	0.17	0.65	10	1.05	0.45	8	1.05	0.45
	$17 < I \leq 100$ [A]	6	1	0.35	1	0.17	0.35	10	1.05	0.45	8	1.05	0.45
	$I > 100$ [A]	6	1	0.35	1	0.17	0.35	10	1.05	0.35	8	1.05	0.35
AC-4	$I \leq 17$ [A]	6	1	0.65	6	1	0.65	12	1.05	0.45	10	1.05	0.45
	$17 < I \leq 100$ [A]	6	1	0.35	6	1	0.35	12	1.05	0.45	10	1.05	0.45
	$I > 100$ [A]	6	1	0.35	6	1	0.35	12	1.05	0.35	10	1.05	0.35
Magnetic contactors for DC circuit switching													
DC-1	1	1	1	1	1	1	1.5	1.05	1	1.5	1.05	1	
DC-3	2.5	1	2	2.5	1	2	4	1.05	2.5	4	1.05	2.5	
DC-5	2.5	1	7.5	2.5	1	7.5	4	1.05	15	4	1.05	15	

Operational current when connected in parallel:

	2 pole in parallel	3 pole in parallel
K	1.6	2.25

Industrial Contactors

CTX³ 3P 9A - 150A

Cat. N°(s) : 4 160 80..84/86/88..94/96/98..99/4 161 00..04/ 4 161 06/08..14/16/18..24/26/28..34/36/38..44/46/48..54/56/ 4 161 58..64/66/68..74/76/78..84/86/88..94/96/98..99/ 4 162 00..04/06/08..14/16/18..24/26/28..34/36/38..43/46/ 4 162 49..53/56/59..63/66/69..73/76/79

5. GENERAL CHARACTERISTICS (continued)

Selection guide for electrical durability:

. For Contactor CTX³ 3P 9~150[A]

- Category AC-1
- Operational voltage : less than AC 440 [V]
- Power factor : more than 0.95
- It follows when it is applied to resistance load such as heating resistance

Category	Making and Breaking capacity		Electric switching durability	
	Making	Breaking	Making	Breaking
AC-1	1.5 I _e , 1.1 U _e Cos Ø 0.95	1.5 I _e , 1.1 U _e Cos Ø 0.95	I _e , U _e Cos Ø 0.95	I _e , U _e Cos Ø 0.95

. With:

- I_e : Rated operational current
- U_e : Rated voltage
- Cos Ø : Power factor

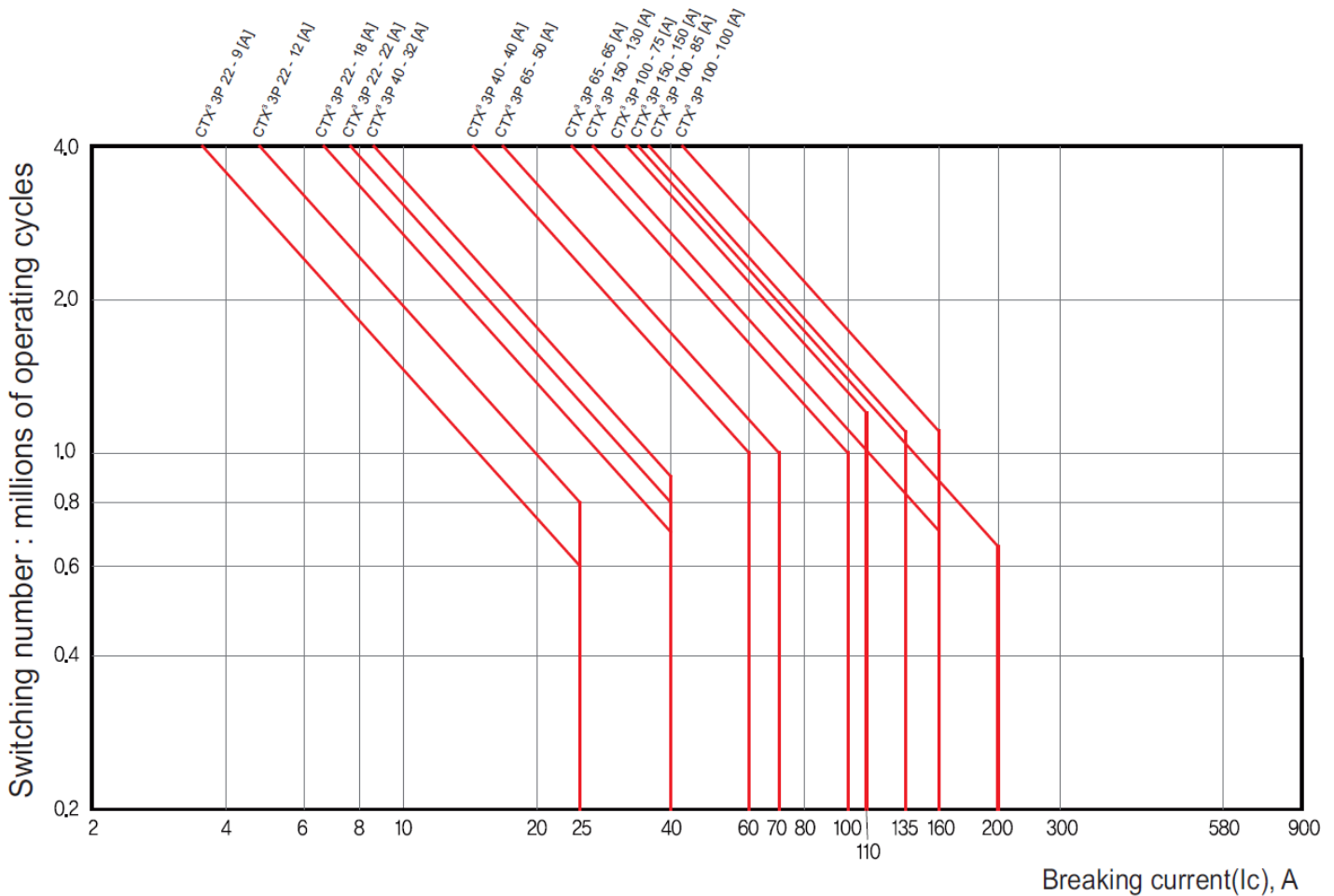

Industrial Contactors

CTX³ 3P 9A - 150A

Cat. N°(s) : 4 160 80..84/86/88..94/96/98..99/4 161 00..04/ 4 161 06/08..14/16/18..24/26/28..34/36/38..44/46/48..54/56/ 4 161 58..64/66/68..74/76/78..84/86/88..94/96/98..99/ 4 162 00..04/06/08..14/16/18..24/26/28..34/36/38..43/46/ 4 162 49..53/56/59..63/66/69..73/76/79

5. GENERAL CHARACTERISTICS (continued)

Selection guide for electrical durability: (continued)

. For Contactor CTX³ 3P 9~150[A]

- Category AC-3
- Operational voltage : less than 440 [V]

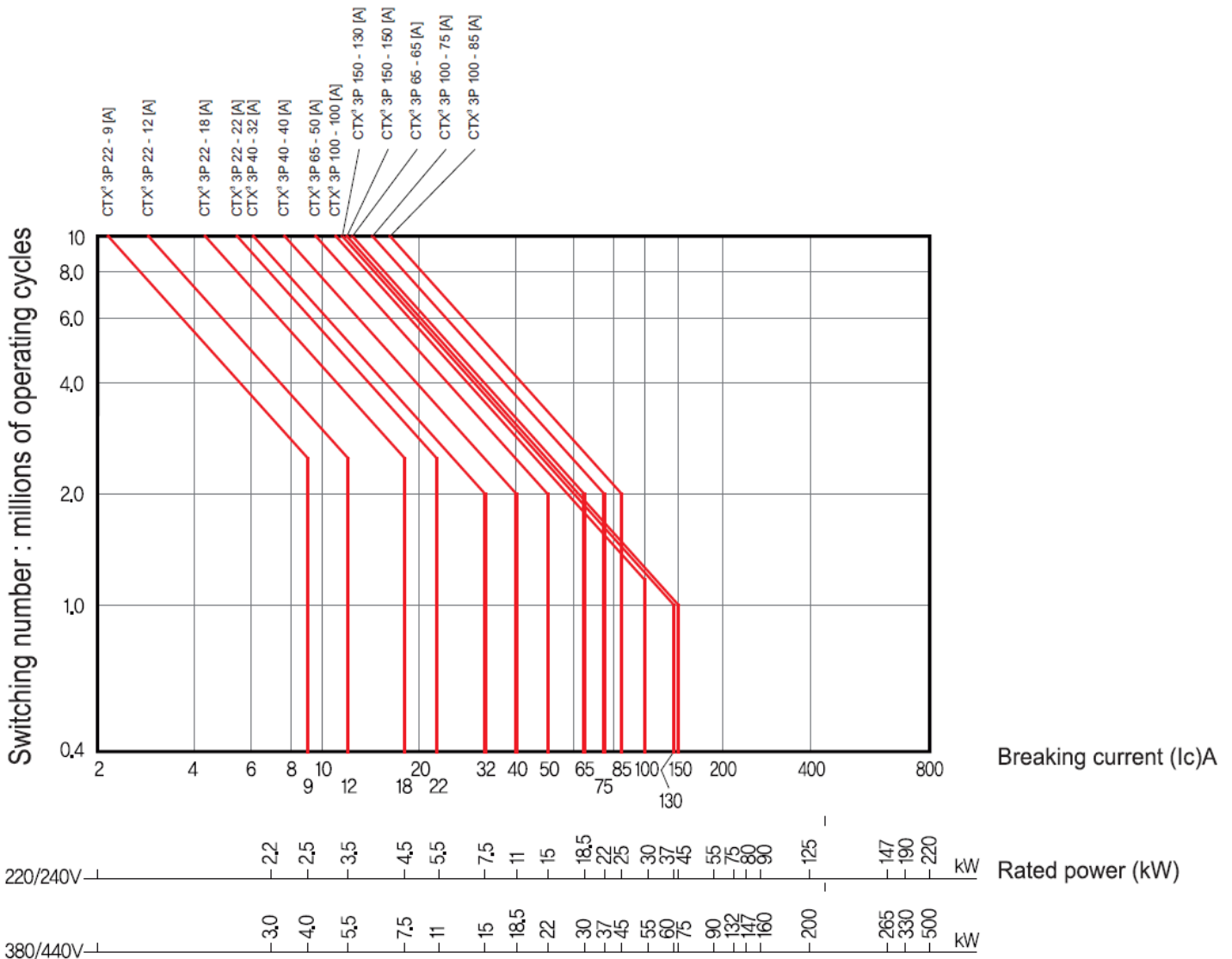

Industrial Contactors

CTX³ 3P 9A - 150A

Cat. N°(s) : 4 160 80..84/86/88..94/96/98..99/4 161 00..04/ 4 161 06/08..14/16/18..24/26/28..34/36/38..44/46/48..54/56/ 4 161 58..64/66/68..74/76/78..84/86/88..94/96/98..99/ 4 162 00..04/06/08..14/16/18..24/26/28..34/36/38..43/46/ 4 162 49..53/56/59..63/66/69..73/76/79

5. GENERAL CHARACTERISTICS (continued)

Selection guide for electrical durability: (continued)

. For Contactor CTX³ 3P 9~150[A]

- Category AC-3
- Operational voltage : less than AC660/690 [V]

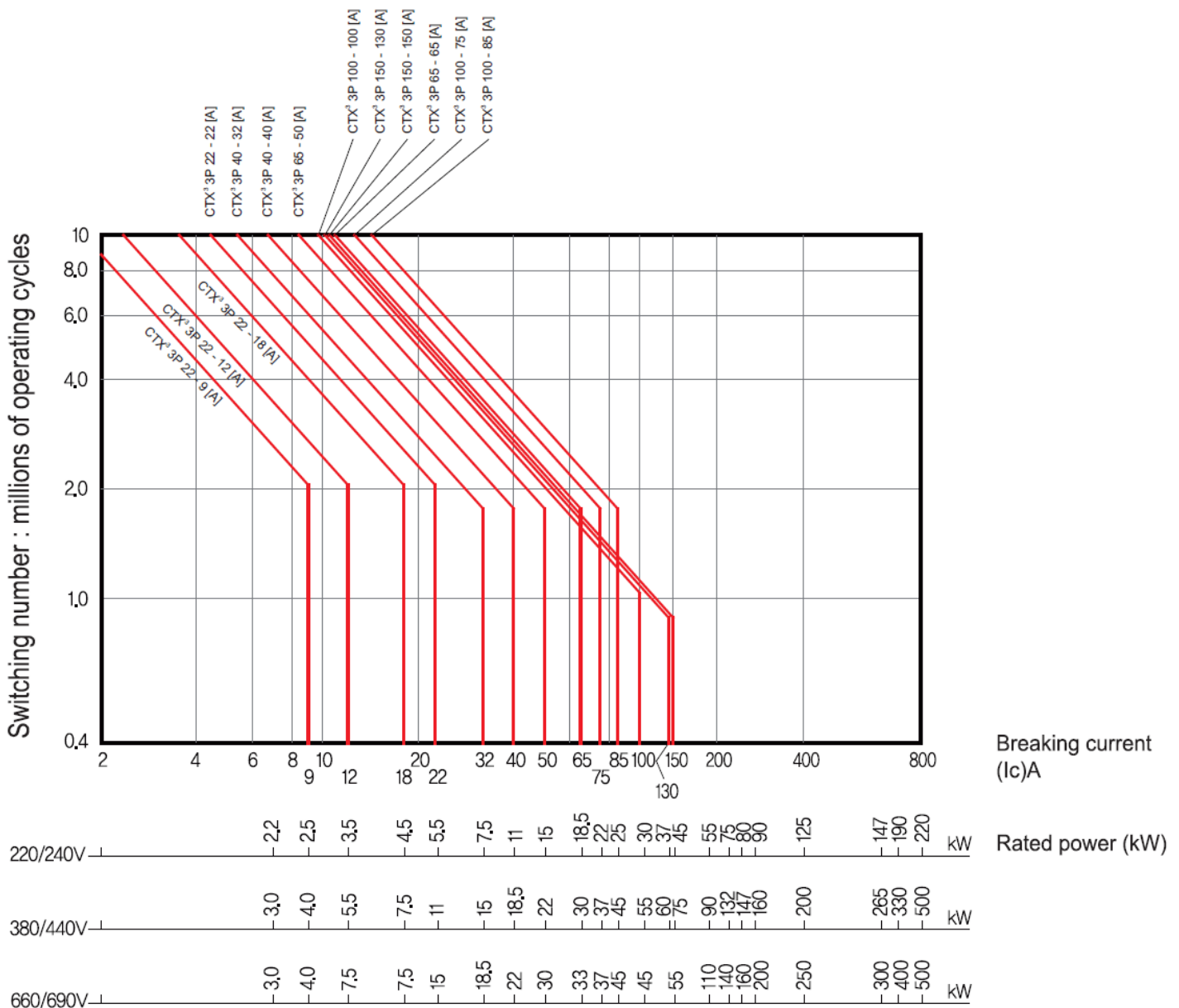

Industrial Contactors

CTX³ 3P 9A - 150A

Cat. N°(s) : 4 160 80..84/86/88..94/96/98..99/4 161 00..04/ 4
 161 06/08..14/16/18..24/26/28..34/36/38..44/46/48..54/56/ 4 161
 58..64/66/68..74/76/78..84/86/88..94/96/98..99/
 4 162 00..04/06/08..14/16/18..24/26/28..34/36/38..43/46/
 4 162 49..53/56/59..63/66/69..73/76/79

5. GENERAL CHARACTERISTICS *(continued)*

Selection guide for electrical durability: *(continued)*

. For Contactor CTX³ 3P 9~150[A]

- Category : AC-4 & AC-3
- Operational voltage : less than AC 440[V] / "B10d"

Range	Product Rating	AC-4			AC-3		
		MTTF	B10d Lifetime	Lifetime	MTTF	B10d Lifetime	Lifetime
CTX ³ 9A	AC440V 6A	131 995	100 725	70 000	3 959 850	3 626 100	2 500 000
CTX ³ 12A	AC440V 9A	120 025	86 068	70 000	3 600 750	3 098 448	2 500 000
CTX ³ 18A	AC440V 11A	186 530	80 451	70 000	5 595 900	2 896 236	2 500 000
CTX ³ 22A	AC440V 13A	191 284	141 369	70 000	5 738 520	5 089 284	2 500 000
CTX ³ 32A	AC440V 17A	82 446	59 939	56 000	2 473 380	2 157 804	2 000 000
CTX ³ 40A	AC440V 24A	68 150	57 555	56 000	2 044 500	2 071 980	2 000 000
CTX ³ 50A	AC440V 32A	106 816	57 195	56 000	3 204 480	2 059 020	2 000 000
CTX ³ 65A	AC440V 47A	91 153	68 173	56 000	2 734 590	2 454 228	2 000 000
CTX ³ 75A	AC440V 52A	72 707	46 902	56 000	2 181 210	1 688 472	2 000 000
CTX ³ 85A	AC440V 62A	101 509	82 905	56 000	3 045 270	2 984 580	2 000 000
CTX ³ 100A	AC440V 75A	63 182	58 216	30 000	1 895 460	1 921 128	1 000 000

. MTTF : Lifetime before breakdown.

Industrial Contactors

CTX³ 3P 9A - 150A

Cat. N°(s) : 4 160 80..84/86/88..94/96/98..99/4 161 00..04/ 4 161 06/08..14/16/18..24/26/28..34/36/38..44/46/48..54/56/ 4 161 58..64/66/68..74/76/78..84/86/88..94/96/98..99/ 4 162 00..04/06/08..14/16/18..24/26/28..34/36/38..43/46/ 4 162 49..53/56/59..63/66/69..73/76/79

5. GENERAL CHARACTERISTICS (continued)

Heating circuit:

. Switching, control, protection

- Single phase 2 pole switching: (Controlled circuit by 2 poles of contactor)

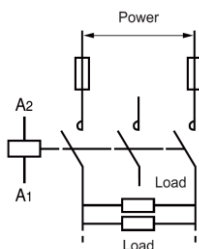

- 3 phases switching: (Controlled circuit by 3 poles of contactor)

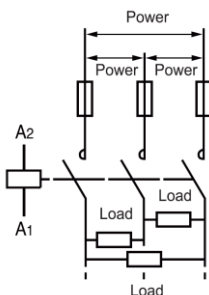

. Component selection according to switching power

- Single phase 2 pole switching: (Controlled circuit by 2 poles of contactor)

Contactor type		CTX ³ 3P 22	CTX ³ 3P 22	CTX ³ 3P 40	CTX ³ 3P 40	CTX ³ 3P 65	CTX ³ 3P 100	CTX ³ 3P 150
		9~12 [A]	18~22 [A]	32 [A]	40 [A]	50~65 [A]	75~100 [A]	130~150 [A]
Maximum power [kW]	220 / 240 [V]	4	5	9	11	14	20	44
	380 / 415 [V]	7	9	15	19	24	35	76
	660 / 690 [V]	12	15.5	25.5	33	41.5	61	118

- 3 phases switching: (Controlled circuit by 3 poles of contactor)

Contactor type		CTX ³ 3P 22	CTX ³ 3P 22	CTX ³ 3P 40	CTX ³ 3P 40	CTX ³ 3P 65	CTX ³ 3P 100	CTX ³ 3P 150
		9~12 [A]	18~22 [A]	32 [A]	40 [A]	50~65 [A]	75~100 [A]	130~150 [A]
Maximum power [kW]	220 / 240 [V]	6	8	15	19	24	34	76
	380 / 415 [V]	11	15.5	26	32	41	59	131
	660 / 690 [V]	21	27	44	57	72	105	206

Industrial Contactors

CTX³ 3P 9A - 150A

Cat. N°(s) : 4 160 80..84/86/88..94/96/98..99/4 161 00..04/ 4 161 06/08..14/16/18..24/26/28..34/36/38..44/46/48..54/56/ 4 161 58..64/66/68..74/76/78..84/86/88..94/96/98..99/ 4 162 00..04/06/08..14/16/18..24/26/28..34/36/38..43/46/ 4 162 49..53/56/59..63/66/69..73/76/79

5. GENERAL CHARACTERISTICS *(continued)*

Switching the primaries of 3 phase LV / LV transformers: In accordance with IEC 947-4-1 (Table VII b).

. Selection of Contactors

- Maximum ambient temperature : +55 [°C]

Contactor type		CTX ³ 3P 22	CTX ³ 3P 22	CTX ³ 3P 22	CTX ³ 3P 22	CTX ³ 3P 40	CTX ³ 3P 40	CTX ³ 3P 65
		9 [A]	12 [A]	18 [A]	22 [A]	32 [A]	40 [A]	50 [A]
Closing maximum operational power [kVA]	220 / 240 [V]	3	4	5	6.1	8.5	16	16
	380 / 400 [V]	5	6.7	8.4	10.2	15	27	27
	415 / 440 [V]	5.5	7.3	9.2	11.2	17	32	32
	500 [V]	6.2	8.3	10.4	12.8	20	36	36
	660 / 690 [V]	8.6	11.5	14.4	17.6	26.5	48	48
Maximum permissible closing peak current - [A]		350	350	420	420	770	1250	1250

Contactor type		CTX ³ 3P 65	CTX ³ 3P 100	CTX ³ 3P 100	CTX ³ 3P 100	CTX ³ 3P 150	CTX ³ 3P 150
		65 [A]	75 [A]	85 [A]	100 [A]	130 [A]	150 [A]
Closing maximum operational power [kVA]	220 / 240 [V]	18	18.1	19.3	24.1	31.3	31.3
	380 / 400 [V]	31	30.1	32.1	40.2	52.2	52.2
	415 / 440 [V]	36	33.2	35.4	44.2	57.5	57.5
	500 [V]	40	37.7	40.2	50.2	65.3	65.3
	660 / 690 [V]	53	52	55.5	69.3	90.1	90.1
Maximum permissible closing peak current - [A]		1400	1400	1550	1650	1800	2000

Control and signalling transformers:

. Transformer sizing for contactors operating

$$P_{\text{inrush}} = 0.8 (\Sigma P_m + \Sigma P_r + P_a)$$

. With:

. ΣP_m = Sum of all contactors holding powers.

. ΣP_r = Sum of all indicators light powers.

. P_a = Inrush power of the largest contactor.

Industrial Contactors

CTX³ 3P 9A - 150A

Cat. N°(s) : 4 160 80..84/86/88..94/96/98..99/4 161 00..04/ 4 161 06/08..14/16/18..24/26/28..34/36/38..44/46/48..54/56/ 4 161 58..64/66/68..74/76/78..84/86/88..94/96/98..99/ 4 162 00..04/06/08..14/16/18..24/26/28..34/36/38..43/46/ 4 162 49..53/56/59..63/66/69..73/76/79

5. GENERAL CHARACTERISTICS *(continued)*

Power terminals heat dissipation:

Type CTX ³ 3P	9 [A]	12 [A]	18 [A]	22 [A]	32 [A]	40 [A]	50 [A]	65 [A]	75 [A]	85 [A]	100 [A]	130 [A]	150 [A]
AC-3 Ie 440 [V]	9	12	18	22	32	40	55	65	75	85	105	125	150
Power dissipation [W]	0.42	0.59	1.13	1.7	3.5	5.6	2.1	3	3.9	5.1	7.7	11	16

Coordination: Type 2

. According to IEC 60947-4-1

Performance: Ue = 220 / 240 [V]		
MPX ³	S	H
MPX ³ 32	50 [kA]	100 [kA]
MPX ³ 63	-	100 [kA]
MPX ³ 100	-	100 [kA]

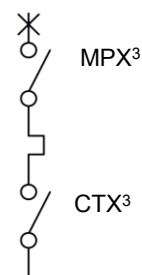

Motor		MPX ³		CTX ³
[kW]	[A]	Type	Rating In [A]	Type
0.37	1.8	MPX ³ 32H	2.5	CTX ³ 22 - 9 [A]
0.55	2.75	MPX ³ 32H	4	
0.75	3.5	MPX ³ 32H	4	CTX ³ 40 - 32 [A]
1.1	4.4	MPX ³ 63H	10	
1.5	6.1	MPX ³ 63H	10	
2.2	8.7	MPX ³ 63H	13	
3	11.5	MPX ³ 63H	13	
3.7	13.5	MPX ³ 63H	18	
4	14.5	MPX ³ 63H	18	
5.5	20	MPX ³ 63H	22	
7.5	27	MPX ³ 63H	32	CTX ³ 40 - 40 [A]
9	32	MPX ³ 100H	32	
10	35	MPX ³ 100H	40	
11	39	MPX ³ 100H	40	
15	52	MPX ³ 100H	63	
18.5	64	MPX ³ 100H	75	
22	75	MPX ³ 100H	75	
25	85	MPX ³ 100H	90	

Industrial Contactors

CTX³ 3P 9A - 150A

Cat. N°(s) : 4 160 80..84/86/88..94/96/98..99/4 161 00..04/ 4 161 06/08..14/16/18..24/26/28..34/36/38..44/46/48..54/56/ 4 161 58..64/66/68..74/76/78..84/86/88..94/96/98..99/ 4 162 00..04/06/08..14/16/18..24/26/28..34/36/38..43/46/ 4 162 49..53/56/59..63/66/69..73/76/79

5. GENERAL CHARACTERISTICS *(continued)*

Coordination: Type 2 *(continued)*

. According to IEC 60947-4-1

Performance: U _e = 415 [V]		
MPX ³	S	H
MPX ³ 32	50 [kA]	50 [kA]
MPX ³ 63	-	50 [kA]
MPX ³ 100	-	50 [kA]

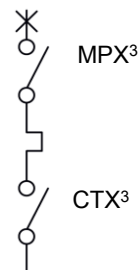

Motor		MPX ³		CTX ³
[kW]	[A]	Type	Rating I _n [A]	Type
0.37	1.1	MPX ³ 32S	1.6	CTX ³ 22 - 9 [A]
0.55	1.5	MPX ³ 32S	1.6	
0.75	1.9	MPX ³ 32S	2.5	CTX ³ 22 - 12 [A]
1.1	2.7	MPX ³ 32S	4	CTX ³ 22 - 18 [A]
1.5	3.6	MPX ³ 32S	4	
2.2	5.2	MPX ³ 32S	6	
3	6.8	MPX ³ 32S	8	
4	9	MPX ³ 32S	10	
5.5	11.5	MPX ³ 32H	13	CTX ³ 22 - 22 [A]
7.5	15.5	MPX ³ 32H	17	
10	20	MPX ³ 32H	22	CTX ³ 40 - 32 [A]
11	22	MPX ³ 32H	26	
15	29	MPX ³ 32H	32	
18.5	35	MPX ³ 63H	40	CTX ³ 40 - 40 [A]
22	41	MPX ³ 63H	50	CTX ³ 65 - 50 [A]
30	55	MPX ³ 63H	63	CTX ³ 65 - 65 [A]
37	67	MPX ³ 100H	75	CTX ³ 100 - 75 [A]
45	80	MPX ³ 100H	100	CTX ³ 100 - 85 [A]

Industrial Contactors

CTX³ 3P 9A - 150A

Cat. N°(s) : 4 160 80..84/86/88..94/96/98..99/4 161 00..04/ 4 161 06/08..14/16/18..24/26/28..34/36/38..44/46/48..54/56/ 4 161 58..64/66/68..74/76/78..84/86/88..94/96/98..99/ 4 162 00..04/06/08..14/16/18..24/26/28..34/36/38..43/46/ 4 162 49..53/56/59..63/66/69..73/76/79

5. GENERAL CHARACTERISTICS (continued)

Coordination: Type 2 (continued)

. According to IEC 60947-4-1

Performance: U _e = 440 [V]		
MPX ³	S	H
MPX ³ 32	38 [kA]	50 [kA]
MPX ³ 63	-	35 [kA]
MPX ³ 100	-	50 [kA]

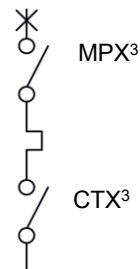

Motor		MPX ³		CTX ³
[kW]	[A]	Type	Rating In [A]	Type
0.37	0.99	MPX ³ 32S	1	CTX ³ 22 - 9 [A]
0.55	1.36	MPX ³ 32S	1.6	
0.75	1.68	MPX ³ 32S	2.5	
1.1	2.37	MPX ³ 32S	2.5	
1.5	3.06	MPX ³ 32S	4	CTX ³ 22 - 18 [A]
2.2	4.42	MPX ³ 32H	6	CTX ³ 22 - 22 [A]
3	5.57	MPX ³ 32H	6	
3.7	7.1	MPX ³ 32H	8	CTX ³ 40 - 32 [A]
4	7.9	MPX ³ 32H	8	
5.5	10.4	MPX ³ 32H	13	
9	16.9	MPX ³ 63H	17	CTX ³ 40 - 40 [A]
11	20.1	MPX ³ 63H	22	
15	26.5	MPX ³ 63H	32	
18.5	32.8	MPX ³ 63H	40	CTX ³ 65 - 50 [A]
22	39	MPX ³ 63H	40	
25	45.3	MPX ³ 63H	50	
30	51.5	MPX ³ 100H	63	CTX ³ 65 - 65 [A]
33	58	MPX ³ 100H	63	
37	64	MPX ³ 100H	63	
40	67	MPX ³ 100H	75	CTX ³ 100 - 85 [A]
45	76	MPX ³ 100H	75	

Industrial Contactors

CTX³ 3P 9A - 150A

Cat. N°(s) : 4 160 80..84/86/88..94/96/98..99/4 161 00..04/ 4 161 06/08..14/16/18..24/26/28..34/36/38..44/46/48..54/56/ 4 161 58..64/66/68..74/76/78..84/86/88..94/96/98..99/ 4 162 00..04/06/08..14/16/18..24/26/28..34/36/38..43/46/ 4 162 49..53/56/59..63/66/69..73/76/79

5. GENERAL CHARACTERISTICS *(continued)*

Coordination: Type 2 *(continued)*

. According to IEC 60947-4-1

Motor		Circuit-breaker				Contactor	Thermal relay			Test	
Rated power (kW)	Rated current (A)	Type	Rated current (A)	Magnetic threshold (A)	Reference	Type	Type	Setting range (A)	Reference	Rated conditional short-circuit current I _q (kA)	Voltage (V)
0,37	1,10	DX ³ -MA	1,6	20	4 098 76	CTX ³ 22 9A	RTX ³ 40	1- 1,6	4 166 45/65	15	400
0,55	1,5	DX ³ -MA	1,6	20	4 098 76	CTX ³ 22 9A	RTX ³ 40	1- 1,6	4 166 45/65	15	400
0,75	1,9	DX ³ -MA	2,5	32	4 098 77	CTX ³ 22 9A	RTX ³ 40	1,6 - 2,5	4 166 46/66	15	400
1,1	2,7	DX ³ -MA	4	50	4 098 78	CTX ³ 22 9A	RTX ³ 40	2,5 - 4	4 166 47/67	15	400
1,5	3,5	DX ³ -MA	4	50	4 098 78	CTX ³ 22 9A	RTX ³ 40	2,5 - 4	4 166 47/67	15	400
2,2	5	DX ³ -MA	6,3	80	4 098 79	CTX ³ 22 9A	RTX ³ 40	4 - 6	4 166 48/68	15	400
2,5	5,7	DX ³ -MA	6,3	80	4 098 79	CTX ³ 22 9A	RTX ³ 40	4 - 6	4 166 48/68	15	400
3	6,7	DX ³ -MA	10	125	4 098 80	CTX ³ 22 12A	RTX ³ 40	5 - 8	4 166 49/69	15	400
3,7	8	DX ³ -MA	10	125	4 098 80	CTX ³ 22 12A	RTX ³ 40	6 - 9	4 166 50/70	15	400
4	8,5	DX ³ -MA	10	125	4 098 80	CTX ³ 22 12A	RTX ³ 40	7 - 10	4 166 51/71	15	400
5,5	11	DX ³ -MA	12,5	160	4 098 81	CTX ³ 22 22A	RTX ³ 40	9 - 13	4 166 52/72	15	400
6,3	13	DX ³ -MA	16	200	4 098 82	CTX ³ 22 22A	RTX ³ 40	12 - 18	4 166 53/73	15	400
7,5	15	DX ³ -MA	16	200	4 098 82	CTX ³ 22 22A	RTX ³ 40	12 - 18	4 166 53/73	15	400
10	20	DX ³ -MA	25	320	4 098 83	CTX ³ 22 22A	RTX ³ 40	16 - 22	4 166 54/74	15	400
11	22	DX ³ -MA	25	320	4 098 83	CTX ³ 22 22A	RTX ³ 40	18 - 25	4 166 55/75	15	400
12,5	25	DX ³ -MA	25	320	4 098 83	CTX ³ 40 32A	RTX ³ 40	22 - 32	4 166 56/76	15	400
15	29	DX ³ -MA	40	500	4 098 84	CTX ³ 40 32A	RTX ³ 40	22 - 32	4 166 56/76	10	400
16	31	DX ³ -MA	40	500	4 098 84	CTX ³ 40 32A	RTX ³ 40	22 - 32	4 166 56/76	10	400
18,5	35	DX ³ -MA	40	500	4 098 84	CTX ³ 40 40A	RTX ³ 40	28 - 40	4 166 57/77	10	400
20	38	DX ³ -MA	40	500	4 098 84	CTX ³ 40 40A	RTX ³ 40	28 - 40	4 166 57/77	10	400
22	41	DX ³ -MA	63	880	4 098 85	CTX ³ 65 50A	RTX ³ 65	34 - 50	4 166 89 4 167 09	10	400
25	47	DX ³ -MA	63	880	4 098 85	CTX ³ 65 50A	RTX ³ 65	34 - 50	4 166 89 4 167 09	10	400
30	57	DX ³ -MA	63	880	4 098 85	CTX ³ 65 65A	RTX ³ 65	45 - 65	4 166 90 4 167 10	10	400
31,5	59	DX ³ -MA	63	880	4 098 85	CTX ³ 65 65A	RTX ³ 65	45 - 65	4 166 90 4 167 10	10	400

Industrial Contactors

CTX³ 3P 9A - 150A

Cat. N°(s) : 4 160 80..84/86/88..94/96/98..99/4 161 00..04/ 4 161 06/08..14/16/18..24/26/28..34/36/38..44/46/48..54/56/ 4 161 58..64/66/68..74/76/78..84/86/88..94/96/98..99/ 4 162 00..04/06/08..14/16/18..24/26/28..34/36/38..43/46/ 4 162 49..53/56/59..63/66/69..73/76/79

5. GENERAL CHARACTERISTICS *(continued)*

Coordination: Type 2 *(continued)*

. According to IEC 60947-4-1

Motor		Circuit-breaker				Contactor	Thermal relay			Test	
Rated power (kW)	Rated current (A)	Type	Rated current (A)	Magnetic threshold (A)	Reference	Type	Type	Setting range (A)	Reference	Conditional short-circuit current I _q (kA)	Voltage (V)
15	29	DPX ³ 160	40	400	4 200 82	CTX ³ 100 85A	RTX ³ 100	24 – 36	4 167 24/44	36	400
16	31	DPX ³ 160	40	400	4 200 82	CTX ³ 100 85A	RTX ³ 100	24 – 36	4 167 24/44	36	400
18,5	35	DPX ³ 160	40	400	4 200 82	CTX ³ 100 85A	RTX ³ 100	28 – 40	4 167 25/45	36	400
20	38	DPX ³ 160	40	400	4 200 82	CTX ³ 100 85A	RTX ³ 100	34 – 50	4 167 26/46	36	400
22	41	DPX ³ 160	63	630	4 200 83	CTX ³ 100 100A	RTX ³ 100	34 – 50	4 167 26/46	36	400
25	47	DPX ³ 160	63	630	4 200 83	CTX ³ 100 100A	RTX ³ 100	45 – 65	4 167 27/47	36	400
30	57	DPX ³ 160	63	630	4 200 83	CTX ³ 100 100A	RTX ³ 100	45 – 65	4 167 27/47	36	400
31,5	59	DPX ³ 160	63	630	4 200 83	CTX ³ 100 100A	RTX ³ 100	54 – 75	4 167 28/48	36	400
37	68	DPX ³ 160	100	1000	4 200 85	CTX ³ 150 130A	RTX ³ 150	54 – 75	4 167 61/71	36	400
40	74	DPX ³ 160	100	1000	4 200 85	CTX ³ 150 130A	RTX ³ 150	63 – 85	4 167 62/72	36	400
45	82	DPX ³ 160	100	1000	4 200 85	CTX ³ 150 130A	RTX ³ 150	63 – 85	4 167 62/72	36	400
50	92	DPX ³ 160	100	1000	4 200 85	CTX ³ 150 130A	RTX ³ 150	80 - 105	4 167 63/73	36	400
55	102	DPX ³ 160	125	1250	4 200 86	CTX ³ 150 150A	RTX ³ 150	95 - 130	4 167 64/74	36	400
63	115	DPX ³ 160	125	1250	4 200 86	CTX ³ 150 150A	RTX ³ 150	95 - 130	4 167 64/74	36	400

Industrial Contactors

CTX³ 3P 9A - 150A

Cat. N°(s) : 4 160 80..84/86/88..94/96/98..99/4 161 00..04/ 4 161 06/08..14/16/18..24/26/28..34/36/38..44/46/48..54/56/ 4 161 58..64/66/68..74/76/78..84/86/88..94/96/98..99/ 4 162 00..04/06/08..14/16/18..24/26/28..34/36/38..43/46/ 4 162 49..53/56/59..63/66/69..73/76/79

5. GENERAL CHARACTERISTICS *(continued)*

Coordination: Type 2 *(continued)*

. According to IEC 60947-4-1

Motor		Circuit-breaker				Contactor	Thermal relay			Test	
Rated power (kW)	Rated current (A)	Type	Rated current (A)	Magnetic threshold (A)	Référence	Type	Type	Setting range (A)	Reference	Conditional short-circuit current I _q (kA)	Voltage (V)
15	29	DPX ³ 160	40	140 - 400	4 201 22	CTX ³ 65 50A	RTX ³ 65	24 - 36	4 166 87 4 167 07	50	400
16	31	DPX ³ 160	40	140 - 400	4 201 22	CTX ³ 65 50A	RTX ³ 65	24 - 36	4 166 87 4 167 07	50	400
18,5	35	DPX ³ 160	40	140 - 400	4 201 22	CTX ³ 65 50A	RTX ³ 65	28 - 40	4 166 88 4 167 08	50	400
20	38	DPX ³ 160	40	140 - 400	4 201 22	CTX ³ 65 50A	RTX ³ 65	34 - 50	4 166 89 4 167 09	50	400
22	41	DPX ³ 160	63	220 - 630	4 201 23	CTX ³ 65 65A	RTX ³ 65	34 - 50	4 166 89 4 167 09	50	400
25	47	DPX ³ 160	63	220 - 630	4 201 23	CTX ³ 100 85A	RTX ³ 100	34 - 50	4 167 26/46	50	400
30	57	DPX ³ 160	63	220 - 630	4 201 23	CTX ³ 100 100A	RTX ³ 100	45 - 65	4 167 27/47	50	400
31,5	59	DPX ³ 160	63	220 - 630	4 201 23	CTX ³ 100 100A	RTX ³ 100	54 - 75	4 167 28/48	50	400
37	68	DPX ³ 250	100	350 - 1000	4 206 05	CTX ³ 100 100A	RTX ³ 100	63 - 85	4 167 29/49	50	400
40	74	DPX ³ 250	100	350 - 1000	4 206 05	CTX ³ 150 130A	RTX ³ 150	63 - 85	4 167 62/72	50	400
45	82	DPX ³ 250	100	350 - 1000	4 206 05	CTX ³ 150 130A	RTX ³ 150	63 - 85	4 167 62/72	50	400
50	92	DPX ³ 250	100	350 - 1000	4 206 05	CTX ³ 150 130A	RTX ³ 150	80 - 105	4 167 63/73	50	400
55	102	DPX ³ 250	100	350 - 1000	4 206 05	CTX ³ 150 150A	RTX ³ 150	95 - 130	4 167 64/74	50	400
63	115	DPX ³ 250	160	560 - 1600	4 206 07	CTX ³ 150 150A	RTX ³ 150	95 - 130	4 167 64/74	50	400

Industrial Contactors

CTX³ 3P 9A - 150A

Cat. N°(s) : 4 160 80..84/86/88..94/96/98..99/4 161 00..04/ 4 161 06/08..14/16/18..24/26/28..34/36/38..44/46/48..54/56/ 4 161 58..64/66/68..74/76/78..84/86/88..94/96/98..99/ 4 162 00..04/06/08..14/16/18..24/26/28..34/36/38..43/46/ 4 162 49..53/56/59..63/66/69..73/76/79

5. GENERAL CHARACTERISTICS *(continued)*

Coordination: Type 2 *(continued)*

. According to IEC 60947-4-1

Motor		Circuit-breaker				Contactor	Thermal relay			Test	
Rated power (kW)	Rated current (A)	Type	Rated current (A)	Magnetic threshold (A)	Référence	Type	Type	Setting range (A)	Reference	Conditional short-circuit current I _q (kA)	Voltage (V)
15	27	DPX ³ 160	40	140 - 400	4 201 22	CTX ³ 65 50A	RTX ³ 65	24 - 36	4 166 87 4 167 07	30	440
16	29	DPX ³ 160	40	140 - 400	4 201 22	CTX ³ 65 50A	RTX ³ 65	24 - 36	4 166 87 4 167 07	30	440
18,5	34	DPX ³ 160	40	140 - 400	4 201 22	CTX ³ 65 65A	RTX ³ 65	28 - 40	4 166 88 4 167 08	30	440
20	37	DPX ³ 160	40	140 - 400	4 201 22	CTX ³ 65 65A	RTX ³ 65	28 - 40	4 166 88 4 167 08	30	440
22	40	DPX ³ 160	40	140 - 400	4 201 23	CTX ³ 100 75A	RTX ³ 100	34 - 50	4 167 26/46	30	440
25	45	DPX ³ 160	63	220 - 630	4 201 23	CTX ³ 100 85A	RTX ³ 100	34 - 50	4 167 26/46	30	440
30	53	DPX ³ 160	63	220 - 630	4 201 23	CTX ³ 100 100A	RTX ³ 100	45 - 65	4 167 27/47	30	440
31,5	56	DPX ³ 160	63	220 - 630	4 201 23	CTX ³ 100 100A	RTX ³ 100	45 - 65	4 167 27/47	30	440
37	65	DPX ³ 250	100	350 - 1000	4 206 05	CTX ³ 100 100A	RTX ³ 100	54 - 75	4 167 28/48	50	440
40	71	DPX ³ 250	100	350 - 1000	4 206 05	CTX ³ 150 130A	RTX ³ 150	63 - 85	4 167 62/72	50	440
45	78	DPX ³ 250	100	350 - 1000	4 206 05	CTX ³ 150 130A	RTX ³ 150	63 - 85	4 167 62/72	50	440
50	88	DPX ³ 250	100	350 - 1000	4 206 05	CTX ³ 150 130A	RTX ³ 150	80 - 105	4 167 63/73	50	440
55	98	DPX ³ 250	100	350 - 1000	4 206 05	CTX ³ 150 150A	RTX ³ 150	80 - 105	4 167 63/73	50	440
63	110	DPX ³ 250	160	560 - 1600	4 206 07	CTX ³ 150 150A	RTX ³ 150	95 - 130	4 167 64/74	50	440

Industrial Contactors

CTX³ 3P 9A - 150A

Cat. N°(s) : 4 160 80..84/86/88..94/96/98..99/4 161 00..04/ 4 161 06/08..14/16/18..24/26/28..34/36/38..44/46/48..54/56/ 4 161 58..64/66/68..74/76/78..84/86/88..94/96/98..99/ 4 162 00..04/06/08..14/16/18..24/26/28..34/36/38..43/46/ 4 162 49..53/56/59..63/66/69..73/76/79

5. GENERAL CHARACTERISTICS *(continued)*

Coordination: Type 2 *(continued)*

. According to IEC 60947-4-1

Star Delta Motor Starter Type 2 Coordination Table :

[KW]	[A] at 440 [V]	MCCB Model	Rating - [A]	Nb. of poles	MC Main	MC Delta	MC Star	TOR Model	Rating - [A]	Short circuit current [kA]
3	6,1	DX ³ MA	10	3P	CTX ³ 22	CTX ³ 22	CTX ³ 22	RTX ³ 40	5 - 8	10
4	7,8	DX ³ MA	10	3P	CTX ³ 40	CTX ³ 40	CTX ³ 22	RTX ³ 40	6 - 10	10
5,5	10	DX ³ MA	12,5	3P	CTX ³ 40	CTX ³ 40	CTX ³ 22	RTX ³ 40	9 - 13	10
7,5	13,6	DX ³ MA	16	3P	CTX ³ 40	CTX ³ 40	CTX ³ 22	RTX ³ 40	11 - 17	6
11	20	DX ³ MA	25	3P	CTX ³ 40	CTX ³ 40	CTX ³ 22	RTX ³ 40	18 - 26	6
15	27	DPX ³ 160A	40	3P	CTX ³ 40	CTX ³ 40	CTX ³ 40	RTX ³ 40	24 - 36	25
18,5	34	DPX ³ 160A	40	3P	CTX ³ 65	CTX ³ 65	CTX ³ 40	RTX ³ 65	28 - 40	25
22	40	DPX ³ 160A	40	3P	CTX ³ 65	CTX ³ 65	CTX ³ 40	RTX ³ 65	34 - 50	25
30	53	DPX ³ 160A	63	3P	CTX ³ 65	CTX ³ 65	CTX ³ 65	RTX ³ 65	45 - 65	25
37	65	DPX ³ 250A	100	3P	CTX ³ 100	CTX ³ 100	CTX ³ 65	RTX ³ 100	54 - 75	50
45	78	DPX ³ 250A	100	3P	CTX ³ 100	CTX ³ 100	CTX ³ 65	RTX ³ 100	63 - 85	50
55	98	DPX ³ 250A	100	3P	CTX ³ 100	CTX ³ 100	CTX ³ 65	RTX ³ 100	80 - 105	50
63	110	DPX ³ 250A	160	3P	CTX ³ 150	CTX ³ 150	CTX ³ 100	RTX ³ 150	95 - 130	50

[KW]	[A] at 440 [V]	MPCB MODEL	Rating - [A]	In - [A]	Nb. of poles	MC Main	MC Delta	MC Star	Short circuit current [kA]
3	5,57	MPX ³ 32S	5 - 8	6	3P	CTX ³ 22	CTX ³ 22	CTX ³ 22	35
4	7,9	MPX ³ 32S	6 - 10	8	3P	CTX ³ 40	CTX ³ 40	CTX ³ 22	35
5,5	10,4	MPX ³ 32H	9 - 13	13	3P	CTX ³ 40	CTX ³ 40	CTX ³ 22	50
7,5	13,7	MPX ³ 32H	11 - 17	17	3P	CTX ³ 40	CTX ³ 40	CTX ³ 22	25
11	20,1	MPX ³ 32H	18 - 26	22	3P	CTX ³ 40	CTX ³ 40	CTX ³ 22	25
15	26,5	MPX ³ 32H	22 - 32	32	3P	CTX ³ 40	CTX ³ 40	CTX ³ 40	25
18,5	32,8	MPX ³ 63H	28 - 40	40	3P	CTX ³ 65	CTX ³ 65	CTX ³ 40	25
22	39	MPX ³ 63H	34 - 50	40	3P	CTX ³ 65	CTX ³ 65	CTX ³ 40	25
30	51,5	MPX ³ 63H	45 - 63	63	3P	CTX ³ 65	CTX ³ 65	CTX ³ 65	25
37	64	MPX ³ 100H	55 - 75	63	3P	CTX ³ 100	CTX ³ 100	CTX ³ 65	50
45	76	MPX ³ 100H	80 - 100	75	3P	CTX ³ 100	CTX ³ 100	CTX ³ 65	50

Industrial Contactors

CTX³ 3P 9A - 150A

Cat. N°(s) : 4 160 80..84/86/88..94/96/98..99/4 161 00..04/ 4 161 06/08..14/16/18..24/26/28..34/36/38..44/46/48..54/56/ 4 161 58..64/66/68..74/76/78..84/86/88..94/96/98..99/ 4 162 00..04/06/08..14/16/18..24/26/28..34/36/38..43/46/ 4 162 49..53/56/59..63/66/69..73/76/79

5. GENERAL CHARACTERISTICS *(continued)*

Coordination: Type 2 *(continued)*

. According to IEC 60947-4-1

Auto Transformer Motor Starter Type 2 Coordination Table :

[KW]	[A] at 440 [V]	MCCB Model	Rating - [A]	Nb. of poles	MC Main	MC Delta	MC Star	TOR Model	Rating - [A]	Short circuit current [kA]
3	6,1	DX ³ MA	10	3P	CTX ³ 22	CTX ³ 22	CTX ³ 22	RTX ³ 40	5 - 8	10
4	7,8	DX ³ MA	10	3P	CTX ³ 40	CTX ³ 40	CTX ³ 22	RTX ³ 40	6 - 10	10
5,5	10	DX ³ MA	12,5	3P	CTX ³ 40	CTX ³ 40	CTX ³ 22	RTX ³ 40	9 - 13	10
7,5	13,6	DX ³ MA	16	3P	CTX ³ 40	CTX ³ 40	CTX ³ 22	RTX ³ 40	11 - 17	6
11	20	DX ³ MA	25	3P	CTX ³ 40	CTX ³ 40	CTX ³ 22	RTX ³ 40	18 - 26	6
15	27	DPX ³ 160A	40	3P	CTX ³ 40	CTX ³ 40	CTX ³ 40	RTX ³ 40	24 - 36	25
18,5	34	DPX ³ 160A	40	3P	CTX ³ 65	CTX ³ 65	CTX ³ 40	RTX ³ 65	28 - 40	25
22	40	DPX ³ 160A	40	3P	CTX ³ 65	CTX ³ 65	CTX ³ 40	RTX ³ 65	34 - 50	25
30	53	DPX ³ 160A	63	3P	CTX ³ 65	CTX ³ 65	CTX ³ 65	RTX ³ 65	45 - 65	25
37	65	DPX ³ 250A	100	3P	CTX ³ 100	CTX ³ 100	CTX ³ 65	RTX ³ 100	54 - 75	50
45	78	DPX ³ 250A	100	3P	CTX ³ 100	CTX ³ 100	CTX ³ 65	RTX ³ 100	63 - 85	50
55	98	DPX ³ 250A	100	3P	CTX ³ 100	CTX ³ 100	CTX ³ 65	RTX ³ 100	80 - 105	50
63	110	DPX ³ 250A	160	3P	CTX ³ 150	CTX ³ 150	CTX ³ 100	RTX ³ 150	95 - 130	50

Industrial Contactors

CTX³ 3P 9A - 150A

Cat. N°(s) : 4 160 80..84/86/88..94/96/98..99/4 161 00..04/ 4 161 06/08..14/16/18..24/26/28..34/36/38..44/46/48..54/56/ 4 161 58..64/66/68..74/76/78..84/86/88..94/96/98..99/ 4 162 00..04/06/08..14/16/18..24/26/28..34/36/38..43/46/ 4 162 49..53/56/59..63/66/69..73/76/79

5. GENERAL CHARACTERISTICS (continued)

Lighting circuit selection guid:

. Incandescent lamp:

- Incandescent lamp, halogen lamp

Contactor	P [W]	60	75	100	150	200	300	500	750	1000
	I [A]	0.27	0.34	0.45	0.68	0.91	1.36	2.27	3.41	4.55
CTX ³ 22 9A	Maximum number of lamp according to P [W]	37	29	22	15	11	7	4	3	2
CTX ³ 22 12A		43	35	26	17	13	9	5	3	3
CTX ³ 22 18A		60	48	36	24	18	12	7	5	4
CTX ³ 22 22A		62	49	37	25	19	12	7	5	4
CTX ³ 40 32A		87	69	52	35	26	17	10	7	5
CTX ³ 40 40A		117	93	70	47	35	23	14	9	7
CTX ³ 65 50A		167	133	100	67	50	33	20	13	10
CTX ³ 65 65A		217	173	130	87	65	43	26	17	13
CTX ³ 100 75A		250	200	150	100	75	50	30	20	15
CTX ³ 100 85A		283	227	170	113	85	57	34	23	17
CTX ³ 100 100A		317	253	190	127	95	63	38	25	19
CTX ³ 150 130A		417	333	250	167	125	83	50	33	25
CTX ³ 150 150A		467	373	280	187	140	93	56	37	28

- Mixed lighting

Contactor	P [W]	100	160	250	500	1000
	I [A]	0.45	0.73	1.14	2.27	4.55
CTX ³ 22 9A	Maximum number of lamp according to P [W]	22	14	9	4	2
CTX ³ 22 12A		26	16	10	5	3
CTX ³ 22 18A		36	23	14	7	4
CTX ³ 22 22A		37	23	15	7	4
CTX ³ 40 32A		52	33	21	10	5
CTX ³ 40 40A		70	44	28	14	7
CTX ³ 65 50A		100	63	40	20	10
CTX ³ 65 65A		130	81	52	26	13
CTX ³ 100 75A		150	94	60	30	15
CTX ³ 100 85A		170	106	68	34	17
CTX ³ 100 100A		190	119	76	38	19
CTX ³ 150 130A		250	156	100	50	25
CTX ³ 150 150A		280	175	112	56	28

Industrial Contactors

CTX³ 3P 9A - 150A

Cat. N°(s) : 4 160 80..84/86/88..94/96/98..99/4 161 00..04/ 4 161 06/08..14/16/18..24/26/28..34/36/38..44/46/48..54/56/ 4 161 58..64/66/68..74/76/78..84/86/88..94/96/98..99/ 4 162 00..04/06/08..14/16/18..24/26/28..34/36/38..43/46/ 4 162 49..53/56/59..63/66/69..73/76/79

5. GENERAL CHARACTERISTICS (continued)

Lighting circuit selection guid: (continued)

- . Fluorescent lamp with starter:
 - Single fitting

Contactor	Type	Not compensated					With AC compensation (parallel connection)				
	P [W]	20	40	65	80	110	20	40	65	80	110
	I [A]	0.39	0.45	0.70	0.80	1.20	0.17	0.26	0.42	0.52	0.72
	C [µF]	-	-	-	-	-	5	5	7	7	16
CTX ³ 22 9A	Maximum number of lamp according to P [W]	41	35	22	20	13	94	61	38	30	22
CTX ³ 22 12A		41	35	22	20	13	94	61	38	30	22
CTX ³ 22 18A		53	46	30	26	17	123	80	50	40	29
CTX ³ 22 22A		53	46	30	26	17	123	80	50	40	29
CTX ³ 40 32A		89	77	50	43	29	205	134	83	67	48
CTX ³ 40 40A		112	97	62	55	36	258	169	104	84	61
CTX ³ 65 50A		143	124	80	70	46	329	215	133	107	77
CTX ³ 65 65A		143	124	80	70	46	329	215	133	107	77
CTX ³ 100 75A		205	177	114	100	66	470	367	190	153	111
CTX ³ 100 85A		205	177	114	100	66	470	367	190	153	111
CTX ³ 100 100A		205	177	114	100	66	470	367	190	153	111
CTX ³ 150 130A		328	283	182	160	106	752	491	304	245	178
CTX ³ 150 150A		410	354	228	200	132	940	614	380	306	222

- Twin fitting

Contactor	Type	Not compensated					With AC compensation (parallel connection)				
	P [W]	2x20	2x40	2x65	2x80	2x110	2x20	2x40	2x65	2x80	2x110
	I [A]	2x0.22	2x0.41	2x0.67	2x0.82	2x1.1	2x0.13	2x0.24	2x0.39	2x0.48	2x0.65
CTX ³ 22 9A	Maximum number of lamp according to P [W]	2x36	2x18	2x10	2x8	2x6	2x60	2x32	2x20	2x16	2x12
CTX ³ 22 12A		2x36	2x18	2x10	2x8	2x6	2x60	2x32	2x20	2x16	2x12
CTX ³ 22 18A		2x46	2x24	2x14	2x12	2x8	2x80	2x42	2x26	2x20	2x16
CTX ³ 22 22A		2x46	2x24	2x14	2x12	2x8	2x80	2x42	2x26	2x20	2x16
CTX ³ 40 32A		2x78	2x42	2x26	2x20	2x14	2x134	2x72	2x44	2x36	2x26
CTX ³ 40 40A		2x100	2x52	2x32	2x26	2x15	2x168	2x90	2x56	2x44	2x32
CTX ³ 65 50A		2x126	2x68	2x40	2x34	2x24	2x214	2x116	2x70	2x58	2x42
CTX ³ 65 65A		2x126	2x68	2x40	2x34	2x24	2x214	2x116	2x70	2x58	2x42
CTX ³ 100 75A		2x180	2x96	2x58	2x48	2x36	2x306	2x166	2x102	2x82	2x60
CTX ³ 100 85A		2x180	2x96	2x58	2x48	2x36	2x306	2x166	2x102	2x82	2x60
CTX ³ 100 100A		2x180	2x96	2x58	2x48	2x36	2x306	2x166	2x102	2x82	2x60
CTX ³ 150 130A		2x380	2x194	2x118	2x96	2x72	2x614	2x332	2x204	2x166	2x122
CTX ³ 150 150A		-	-	-	-	-	-	-	-	-	-

Industrial Contactors

CTX³ 3P 9A - 150A

Cat. N°(s) : 4 160 80..84/86/88..94/96/98..99/4 161 00..04/ 4 161 06/08..14/16/18..24/26/28..34/36/38..44/46/48..54/56/ 4 161 58..64/66/68..74/76/78..84/86/88..94/96/98..99/ 4 162 00..04/06/08..14/16/18..24/26/28..34/36/38..43/46/ 4 162 49..53/56/59..63/66/69..73/76/79

5. GENERAL CHARACTERISTICS (continued)

Lighting circuit selection guide: (continued)

- Fluorescent lamp without starter:
 - Single fitting

Contactor	Type	Not compensated					With AC compensation (parallel connection)				
	P [W]	20	40	65	80	110	20	40	65	80	110
	I [A]	0.39	0.45	0.70	0.80	1.20	0.17	0.26	0.42	0.52	0.72
	C [μF]	-	-	-	-	-	5	5	7	7	16
CTX ³ 22 9A	Maximum number of lamp according to P [W]	37	29	20	16	11	84	55	34	28	20
CTX ³ 22 12A		37	29	20	16	11	84	55	34	28	20
CTX ³ 22 18A		48	38	26	22	15	110	72	45	36	26
CTX ³ 22 22A		48	38	26	22	15	110	72	45	36	26
CTX ³ 40 32A		97	63	43	36	25	184	101	76	61	44
CTX ³ 40 40A		112	97	62	55	36	258	169	104	84	61
CTX ³ 65 50A		130	101	70	58	40	294	193	121	98	70
CTX ³ 65 65A		130	101	70	58	40	294	193	121	98	70
CTX ³ 100 75A		186	145	100	84	57	421	275	173	140	101
CTX ³ 100 85A		186	145	100	84	57	421	275	173	140	101
CTX ³ 100 100A		186	145	100	84	57	421	275	173	140	101
CTX ³ 150 130A		372	290	200	168	114	842	550	340	280	202
CTX ³ 150 150A		410	320	221	186	120	929	609	383	309	223

- Twin fitting

Contactor	Type	Not compensated					With AC compensation (parallel connection)				
	P [W]	2x20	2x40	2x65	2x80	2x110	2x20	2x40	2x65	2x80	2x110
	I [A]	2x0.22	2x0.41	2x0.67	2x0.82	2x1.1	2x0.13	2x0.24	2x0.39	2x0.48	2x0.65
CTX ³ 22 9A	Maximum number of lamp according to P [W]	2x32	2x16	2x10	2x8	2x6	2x56	2x30	2x18	2x14	2x10
CTX ³ 22 12A		2x32	2x16	2x10	2x8	2x6	2x56	2x30	2x18	2x14	2x10
CTX ³ 22 18A		2x42	2x22	2x12	2x10	2x8	2x74	2x40	2x24	2x18	2x14
CTX ³ 22 22A		2x42	2x22	2x12	2x10	2x8	2x74	2x40	2x24	2x18	2x14
CTX ³ 40 32A		2x70	2x36	2x22	2x18	2x12	2x124	2x66	2x40	2x32	2x24
CTX ³ 40 40A		2x88	2x46	2x28	2x22	2x16	2x156	2x84	2x50	2x40	2x30
CTX ³ 65 50A		2x112	2x58	2x36	2x30	2x20	2x200	2x106	2x64	2x52	2x38
CTX ³ 65 65A		2x112	2x58	2x36	2x30	2x20	2x200	2x106	2x64	2x52	2x38
CTX ³ 100 75A		2x160	2x84	2x52	2x42	2x30	2x234	2x152	2x92	2x74	2x54
CTX ³ 100 85A		2x160	2x84	2x52	2x42	2x30	2x234	2x152	2x92	2x74	2x54
CTX ³ 100 100A		2x160	2x84	2x52	2x42	2x30	2x234	2x152	2x92	2x74	2x54
CTX ³ 150 130A		2x320	2x170	2x104	2x86	2x60	2x570	2x306	2x186	2x150	2x110
CTX ³ 150 150A		2x353	2x187	2x115	2x93	2x68	2x631	2x338	2x204	2x165	2x121

Industrial Contactors

CTX³ 3P 9A - 150A

Cat. N°(s) : 4 160 80..84/86/88..94/96/98..99/4 161 00..04/ 4 161 06/08..14/16/18..24/26/28..34/36/38..44/46/48..54/56/ 4 161 58..64/66/68..74/76/78..84/86/88..94/96/98..99/ 4 162 00..04/06/08..14/16/18..24/26/28..34/36/38..43/46/ 4 162 49..53/56/59..63/66/69..73/76/79

5. GENERAL CHARACTERISTICS (continued)

Lighting circuit selection guid: (continued)

. Sodium vapor lamp:

- Low pressure sodium vapor lamps

Contactor	Type	Not compensated							With AC compensation (parallel connection)						
	P [W]	35	55	90	135	150	180	200	35	55	90	135	150	180	200
	I [A]	1.2	1.6	2.4	3.1	3.2	3.3	3.4	0.3	0.4	0.6	0.9	1	1.2	1.3
	C [μF]	-	-	-	-	-	-	-	17	17	25	36	36	36	36
CTX ³ 22 9A	Maximum number of lamp according to P [W]	10	7	5	3	3	3	3	40	30	-	-	-	-	-
CTX ³ 22 12A		10	7	5	3	3	3	3	40	30	-	-	-	-	-
CTX ³ 22 18A		12	9	6	4	4	4	4	50	37	25	-	-	-	-
CTX ³ 22 22A		12	9	6	4	4	4	4	50	37	25	-	-	-	-
CTX ³ 40 32A		21	16	10	8	8	7	7	86	65	43	28	26	21	20
CTX ³ 40 40A		27	20	13	10	10	10	9	110	82	55	36	33	27	25
CTX ³ 65 50A		35	26	17	13	13	12	12	140	105	70	46	42	35	32
CTX ³ 65 65A		35	26	17	13	13	12	12	140	105	70	46	42	35	32
CTX ³ 100 75A		50	37	25	19	18	18	17	200	150	100	66	60	50	46
CTX ³ 100 85A		50	37	25	19	18	18	17	200	150	100	66	60	50	46
CTX ³ 100 100A		50	37	25	19	18	18	17	200	150	100	66	60	50	46
CTX ³ 150 130A		100	75	50	38	36	36	34	400	300	200	132	120	100	92
CTX ³ 150 150A		129	129	129	129	129	129	129	129	129	129	129	129	129	129

- High pressure sodium vapor lamps

Contactor	Type	Not compensated					With AC compensation (parallel connection)				
	P [W]	3.5	5.5	90	135	150	3.5	55	90	135	150
	I [A]	1.2	1.6	2.4	3.1	3.2	0.3	0.4	0.6	0.9	1
	C [μF]	-	-	-	-	-	17	17	25	36	36
CTX ³ 22 9A	Maximum number of lamp according to P [W]	6	3	2	1	-	-	-	-	-	-
CTX ³ 22 12A		6	3	2	1	-	-	-	-	-	-
CTX ³ 22 18A		7	4	3	1	1	17	-	-	-	-
CTX ³ 22 22A		7	4	3	1	1	17	-	-	-	-
CTX ³ 40 32A		13	8	5	2	2	30	18	11	6	-
CTX ³ 40 40A		17	10	6	3	2	39	23	15	8	6
CTX ³ 65 50A		22	13	8	4	3	50	30	19	10	7
CTX ³ 65 65A		22	13	8	4	3	50	30	19	10	7
CTX ³ 100 75A		31	18	12	6	4	71	42	27	15	10
CTX ³ 100 85A		31	18	12	6	4	71	42	27	15	10
CTX ³ 100 100A		31	18	12	6	4	71	42	27	15	10
CTX ³ 150 130A		62	36	24	12	8	142	84	54	30	20
CTX ³ 150 150A		81	48	31	17	13	184	110	70	39	28

Industrial Contactors

CTX³ 3P 9A - 150A

Cat. N°(s) : 4 160 80..84/86/88..94/96/98..99/4 161 00..04/ 4 161 06/08..14/16/18..24/26/28..34/36/38..44/46/48..54/56/ 4 161 58..64/66/68..74/76/78..84/86/88..94/96/98..99/ 4 162 00..04/06/08..14/16/18..24/26/28..34/36/38..43/46/ 4 162 49..53/56/59..63/66/69..73/76/79

5. GENERAL CHARACTERISTICS (continued)

Lighting circuit selection guid: (continued)

. Mercury lamp:

- High pressure mercury vapor lamps

Contactor	Type	Not compensated							With AC compensation (parallel connection)						
	P [W]	50	80	125	250	400	700	1000	35	55	90	135	150	185	200
	I [A]	0.54	0.81	1.20	2.30	4.10	6.80	9.90	0.30	0.45	0.67	1.30	2.30	3.80	5.50
	C [μF]	-	-	-	-	-	-	-	10	10	10	18	25	40	60
CTX ³ 22 9A	Maximum number of lamp according to P [W]	22	14	9	5	2	1	1	40	26	17	9	-	-	-
CTX ³ 22 12A		22	14	9	5	2	1	1	40	26	17	9	-	-	-
CTX ³ 22 18A		27	18	12	6	3	2	1	50	33	22	11	6	-	-
CTX ³ 22 22A		27	18	12	6	3	2	1	50	33	22	11	6	-	-
CTX ³ 40 32A		48	32	21	11	6	3	2	86	57	38	20	11	6	4
CTX ³ 40 40A		61	40	27	14	8	4	3	110	73	49	25	14	8	6
CTX ³ 65 50A		77	51	34	17	10	6	4	140	93	62	32	18	11	7
CTX ³ 65 65A		77	51	34	17	10	6	4	140	93	62	32	18	11	7
CTX ³ 100 75A		111	74	49	26	14	8	6	200	133	89	46	26	15	10
CTX ³ 100 85A		111	74	49	26	14	8	6	200	133	89	46	26	15	10
CTX ³ 100 100A		111	74	49	26	14	8	6	200	133	89	46	26	15	10
CTX ³ 150 130A		222	146	100	52	28	16	12	400	266	178	92	52	30	20
CTX ³ 150 150A		285	190	129	66	37	22	16	515	342	230	118	66	40	28

- Metal iodide lamps

Contactor	Type	Not compensated				With AC compensation (parallel connection)			
	P [W]	35	55	90	100	35	55	90	100
	I [A]	1.2	1.6	2.4	3.2	0.3	0.4	0.6	1
	C [μF]	-	-	-	-	17	17	25	36
CTX ³ 22 9A	Maximum number of lamp according to P [W]	4	3	1	-	-	-	-	-
CTX ³ 22 12A		4	3	1	-	-	-	-	-
CTX ³ 22 18A		6	4	1	-	-	-	-	-
CTX ³ 22 22A		6	4	1	-	-	-	-	-
CTX ³ 40 32A		10	7	2	1	18	13	4	-
CTX ³ 40 40A		13	9	3	1	23	16	6	-
CTX ³ 65 50A		16	11	4	2	30	21	7	-
CTX ³ 65 65A		16	11	4	2	30	21	7	-
CTX ³ 100 75A		24	16	6	3	42	30	11	5
CTX ³ 100 85A		24	16	6	3	42	30	11	5
CTX ³ 100 100A		24	16	6	3	42	30	11	5
CTX ³ 150 130A		48	32	12	6	84	60	22	10
CTX ³ 150 150A		61	42	17	7	110	77	29	13

Industrial Contactors

CTX³ 3P 9A - 150A

Cat. N°(s) : 4 160 80..84/86/88..94/96/98..99/4 161 00..04/ 4 161 06/08..14/16/18..24/26/28..34/36/38..44/46/48..54/56/ 4 161 58..64/66/68..74/76/78..84/86/88..94/96/98..99/ 4 162 00..04/06/08..14/16/18..24/26/28..34/36/38..43/46/ 4 162 49..53/56/59..63/66/69..73/76/79

6. CONFORMITIES AND APPROVALS

Compliance to standards:

. Standards references: IEC/EN 60 947-1, IEC/EN 60 947-4-1 and UL 508.

. Certifications: CE, UL, EAC.

7. AUXILIARIES AND ACCESSORIES

Auxiliaries:

Installation principle:

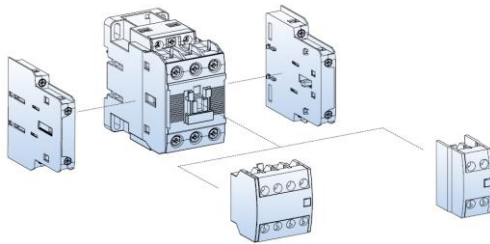

Rating:

Type		CTX ³ Auxiliary contact side (2P)	CTX ³ Auxiliary front side (2P & 4P)	
Rated operation voltage (Ue)		600 [V]	600 [V]	
Rated insulation voltage (Ui)		600 [V]	600 [V]	
Rated impulse withstand voltage (Uimp)		6 [kV]	6 [kV]	
Rated frequency		50 / 60 [Hz]	50 / 60 [Hz]	
Contact sensibility	Voltage	DC 17 [V]	DC 24 [V]	
	Current	DC 5 [mA]	DC 10 [mA]	
Rated thermal current (Ith, AC 12 duty)		10 [A]	16 [A]	
Rated operation current	AC 15 duty	120 [V]	6 [A]	6 [A]
		240 [V]	3 [A]	3 [A]
		380 [V]	1.9 [A]	1.9 [A]
		480 [V]	1.5 [A]	1.5 [A]
		500 [V]	1.4 [A]	1.4 [A]
	DC 13 duty	600 [V]	1.2 [A]	1.2 [A]
		125 [V]	1.1 [A]	1.1 [A]
		250 [V]	0.55 [A]	0.55 [A]
		400 [V]	0.31 [A]	0.31 [A]
		500 [V]	0.27 [A]	0.27 [A]
Rated short-time withstand current		600 [V]	0.2 [A]	0.2 [A]
	1 [s]	100 [A]	-	
	0.5 [s]	125 [A]	-	
	0.1 [s]	145 [A]	-	
Electrical lifetime (mil. operations)	AC 15 duty	220 [V]	0.25	0.25
		440 [V]	0.25	0.25
	DC 13 duty	220 [V]	0.25	0.25
		440 [V]	0.25	0.25
Maximum operating cycles per hour		1800	1800	
Conductor size (solid, stranded)	[AWG]	18~10	18~10	
	[mm ²]	1~2.5	1~2.5	

. Minimum current of Auxiliary contactor is DC 17 [V] 5 [mA].

7. AUXILIARIES AND ACCESSORIES (continued)

Auxiliaries: (continued)

CTX³ auxiliary contact side: weight = 0.53 [kg]
- 1NO + 1NC (cat n° 4 168 58)

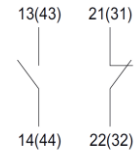

1NO + 1NC

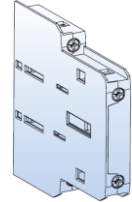

. Normally closed (NC) auxiliary contact meet the requirements of mirror contacts in IEC 60 947-4-1 (Annex F).

. For Contactors CTX³ 3P from 9 to 150 [A].

CTX³ auxiliary contact front: weight = 0.50 [kg]

- 4NO (cat n° 4 168 53).
- 3NO + 1NC (cat n° 4 168 54)
- 2NO + 2NC (cat n° 4 168 55)
- 1NO + 3NC (cat n° 4 168 56)
- 4NC (cat n° 4 168 57)

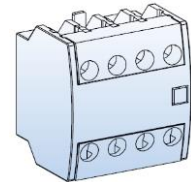
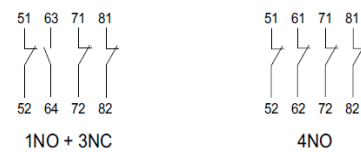
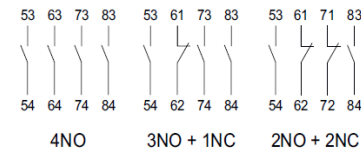

For Contactors CTX³ 3P from 9 to 150 [A].

CTX³ auxiliary contact front: weight = 0.28 [kg]

- 1NO + 1NC (cat n° 4 168 50)
- 2NO (cat n° 4 168 51)
- 2NC (cat n° 4 168 52)

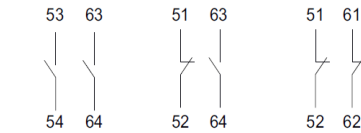

1NO + 1NC 2NO 2NC

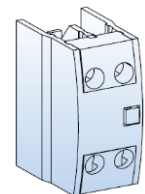

For Contactors CTX³ 3P from 9 to 150 [A].

Industrial Contactors

CTX³ 3P 9A - 150A

Cat. N°(s) : 4 160 80..84/86/88..94/96/98..99/4 161 00..04/ 4 161 06/08..14/16/18..24/26/28..34/36/38..44/46/48..54/56/ 4 161 58..64/66/68..74/76/78..84/86/88..94/96/98..99/ 4 162 00..04/06/08..14/16/18..24/26/28..34/36/38..43/46/ 4 162 49..53/56/59..63/66/69..73/76/79

7. AUXILIARIES AND ACCESSORIES (continued)

Auxiliaries: (continued)

Maximum combination of Auxiliaries:

Type of products	CTX ³ Auxiliary contact side (2P)	CTX ³ Auxiliary front side (2P)	CTX ³ Auxiliary front side (4P)
CTX ³ 3P 9A~22A	1 (on one side)	-	1
	1 (on one side)	1	-
	2 (on both sides)	-	-
CTX ³ 3P 32A~150A	2 (1 on both sides)	-	1
	2 (1 on both sides)	1	-
	4 (2 on both sides)	-	-

Making Breaking conditions according to application categories: According to IEC/EN 60 947-4-1

Category	Normal operation						Occasional operation					
	Making			Breaking			Making			Breaking		
	I	U	Cos Ø	I	U	Cos Ø	I	U	Cos Ø	I	U	Cos Ø
AC-14	6 I _e	U _e	0.3	I _e	U _e	0.3	6 I _e	1.1 U _e	0.7	6 I _e	1.1 U _e	0.7
AC-15	10 I _e	U _e	0.3	I _e	U _e	0.3	10 I _e	1.1 U _e	0.3	10 I _e	1.1 U _e	0.3
DC-13	I _e	U _e	6P	I _e	U _e	6P	1.1 I _e	1.1 U _e	6P	I _e	1.1 U _e	6P

. With:

. I = Inserted and breaking current express symmetric element value such as mean square of DC or AC.

. I_e = Rated current.

. U = Voltage recovery.

. U_e = Rated operation voltage.

. Cos Ø = Power factor.

. The value 6P [W] is based on real axis, P = 50 [W], in other words it indicates the most magnetic load up to maximum limit of 6P = 300 [ms] = L/R. The upper load of this consists of smaller loads in parallel. Therefore 300 [ms] is the maximum limit regardless of rated current value.

Industrial Contactors

CTX³ 3P 9A - 150A

Cat. N°(s) : 4 160 80..84/86/88..94/96/98..99/4 161 00..04/ 4 161 06/08..14/16/18..24/26/28..34/36/38..44/46/48..54/56/ 4 161 58..64/66/68..74/76/78..84/86/88..94/96/98..99/ 4 162 00..04/06/08..14/16/18..24/26/28..34/36/38..43/46/ 4 162 49..53/56/59..63/66/69..73/76/79

7. AUXILIARIES AND ACCESSORIES (continued)

Auxiliaries: (continued)

Combined devices:

- . Installation principle:
 - Contactor CTX³ with MPCB MPX³

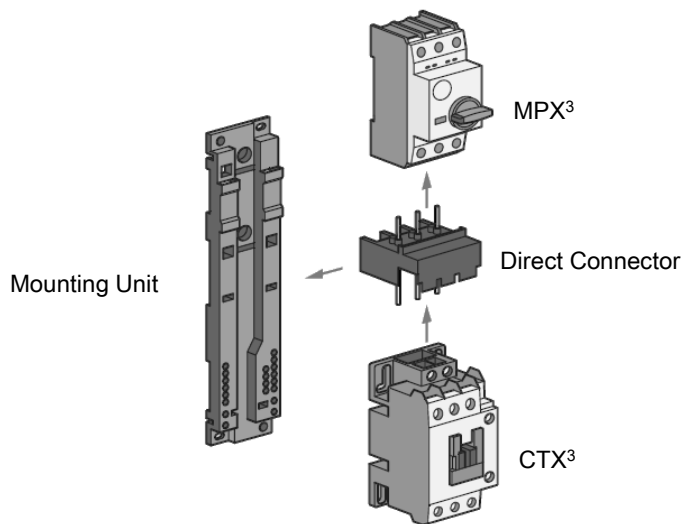

Direct connector	Mounting Unit	MPX ³	CTX ³	
4 174 40	Mounting Unit MPX ³ 32S / 32H / 32MA 4 174 60	MPX ³ 32S	CTX ³ mini AC	
4 174 41			CTX ³ mini DC	
4 174 48			CTX ³ 22 AC	
4 174 49			CTX ³ 22 DC	
4 174 52			CTX ³ 40 AC	
4 174 53			CTX ³ 40 DC	
4 174 42		MPX ³ 32H / 32MA	CTX ³ mini AC	
4 174 43			CTX ³ mini DC	
4 174 50			CTX ³ 22 AC	
4 174 51			CTX ³ 22 DC	
4 174 54			CTX ³ 40 AC	
4 174 55			CTX ³ 40 DC	
4 174 56			MPX ³ 63H	CTX ³ 65 AC
4 174 57				CTX ³ 65 DC
4 174 58	MPX ³ 100H	CTX ³ 100 AC		
4 174 59		CTX ³ 100 DC		

7. AUXILIARIES AND ACCESSORIES (continued)

Auxiliaries: (continued)

Combined devices: (continued)

- . For more information, refer to the technical data sheet of RTX³.

Installation principle:

- Contactor CTX³ with Thermal Overload Relay RTX³

Type of products	Directly mountable Overload relay
CTX ³ 22	RTX ³ 40
CTX ³ 40	RTX ³ 40
CTX ³ 65	RTX ³ 65
CTX ³ 100	RTX ³ 100
CTX ³ 150	RTX ³ 150

Accessories:

Interlock CTX³: weight = 0.06 [kg]

- Interlock CTX³ 3P (cat n° 4 168 80)

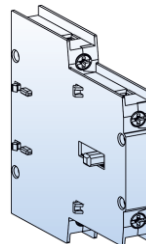

- . For Contactors CTX³ 3P from 9 to 150 [A].
- . Mechanical association permitted for equivalent size contactors only.

Wiring kit interlock:

- Wiring kit interlock CTX³ 22 3P (cat n° 4 168 82) (weight = 0.04 [kg])
- Wiring kit interlock CTX³ 40 3P (cat n° 4 168 83) (weight = 0.05 [kg])
- Wiring kit interlock CTX³ 65 3P (cat n° 4 168 84) (weight = 0.12 [kg])
- Wiring kit interlock CTX³ 100 3P (cat n° 4 168 85) (weight = 0.33 [kg])

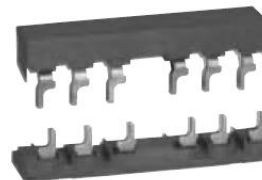

- . For Contactors CTX³ 3P from 9 to 100 [A].

Industrial Contactors

CTX³ 3P 9A - 150A

Cat. N°(s) : 4 160 80..84/86/88..94/96/98..99/4 161 00..04/ 4 161 06/08..14/16/18..24/26/28..34/36/38..44/46/48..54/56/ 4 161 58..64/66/68..74/76/78..84/86/88..94/96/98..99/ 4 162 00..04/06/08..14/16/18..24/26/28..34/36/38..43/46/ 4 162 49..53/56/59..63/66/69..73/76/79

7. AUXILIARIES AND ACCESSORIES (continued)

Accessories: (continued)

Rating of the contacts in the interlocks:

Rated operation voltage (Ue)	600 [V]		
Rated insulation voltage (Ui)	600 [V]		
Rated frequency	50 / 60 [Hz]		
Rated thermal current (Ith)	10 [A]		
Rated operation current	AC 15 duty	120 [V]	6 [A]
		240 [V]	3 [A]
		380 [V]	1.9 [A]
		480 [V]	1.5 [A]
	DC 13 duty	500 [V]	1.4 [A]
		600 [V]	1.2 [A]
		125 [V]	0.55 [A]
		250 [V]	0.27 [A]

CTX³ Varistor:

- . It absorbs the surge arisen out of the coil of the contactor.
- . It can be installed simply to the contactor terminals A1 A2.
- . Conform to IEC 61000-4-5 (surge immunity test).

- CTX³ Varistor 24~48 [V] AC/DC (cat n° 4 168 95)
- CTX³ Varistor 100~125 [V] AC/DC (cat n° 4 168 96)
- CTX³ Varistor 200~240 [V] AC/DC (cat n° 4 168 97)
- CTX³ Varistor 380~440 [V] AC (cat n° 4 168 98)

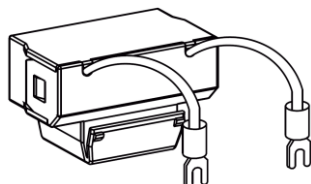

Rated operation voltage (Ue)	AC 24 ~ 440V DC 24 ~ 125V
Rated insulation voltage (Ui)	1000 [V]
Rated impulse withstand voltage (Uimp)	8 [kV]
Degree of protection	IP20

- . For Contactors CTX³ 3P from 9 to 150 [A].

7. AUXILIARIES AND ACCESSORIES (continued)

Accessories: (continued)

CTX³ Safety front cover:

- CTX³ Safety front cover from 9 - 150 [A]
(cat n° 4 168 40)

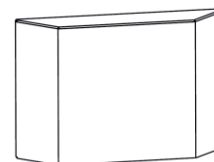

- . For Contactors CTX³ 3P: All products.

Time delay blocks:

- CTX³ electronic timer ON delay, 1 - 30 [s] / 24 - 48 [V~/=]
(cat n° 4 168 70)
- CTX³ electronic timer ON delay, 1 - 30 [s] / 110 - 230 [V~]
(cat n° 4 168 71)
- CTX³ electronic timer OFF delay, 1 - 30 [s] / 24 - 48 [V~/=]
(cat n° 4 168 72)
- CTX³ electronic timer OFF delay, 1 - 30 [s] / 110 - 230 [V~]
(cat n° 4 168 73)

- . For Contactors CTX³ 3P from 9 to 150 [A].



- . Frequency: 50/60 [Hz].

. Operation:

- Min. voltage = 85 [%]
- Maxi. voltage = 110 [%]

- . Accuracy of setting time: ±20 [%].

Capacitor switching unit: (for CTX³ 3P up to 100 [A])

- For CTX³ 9 - 40 [A] (cat n° 4 168 74)
- For CTX³ 50 - 65 [A] screw terminals (cat n° 4 168 75)
- For CTX³ 50 - 100 [A] cage terminals (cat n° 4 168 76)
- For CTX³ 75 - 100 [A] screw terminals (cat n° 4 168 77)

- . For more information, refer to the technical data sheet of Capacitor switching units.

Installation software:

- . XL PRO³.