

# 3-pole contactors CTX<sup>3</sup>

130 A to 800 A industrial contactors



4 162 46



4 162 56



4 162 96



4 163 56

Technical characteristics **p. 188**  
 Dimensions and coordination with circuit breakers **see e-catalogue**

Conform to IEC 60947-1, IEC 60947-4-1  
 Can be equipped with RTX<sup>3</sup> thermal relays (p. 184-185) add-on auxiliary contact blocks, time delay blocks (except CTX<sup>3</sup> 225/400/800) and CTX<sup>3</sup> interlocking (p. 186)

Pack	Cat.Nos		CTX <sup>3</sup> 150		
			With integrated auxiliary contacts		
			<b>130 A (AC3) - 160 A (AC1)</b>		
	Screw terminals	Cage terminals	3-phase motor 400/415 V	Control Voltage	Integrated auxiliary contacts
1	4 162 40	4 162 50	60 kW	24 V $\sim$	2 NO + 2 NC
1	4 162 41	4 162 51	60 kW	24 V $\equiv$	2 NO + 2 NC
1	4 162 46	4 162 56	60 kW	100-240 V $\sim/\equiv$	2 NO + 2 NC
1	4 162 49	4 162 59	60 kW	400-440 V $\sim$	2 NO + 2 NC
			<b>150 A (AC3) - 210 A (AC1)</b>		
1	4 162 60	4 162 70	75 kW	24 V $\sim$	2 NO + 2 NC
1	4 162 61	4 162 71	75 kW	24 V $\equiv$	2 NO + 2 NC
1	4 162 66	4 162 76	75 kW	100-240 V $\sim/\equiv$	2 NO + 2 NC
1	4 162 69	4 162 79	75 kW	400-440 V $\sim$	2 NO + 2 NC

Pack	Cat.Nos		CTX <sup>3</sup> 225		
			With integrated auxiliary contacts		
			<b>185 A (AC3) - 230 A (AC1)</b>		
	Screw terminals		3-phase motor 400/415 V	Control Voltage	Integrated auxiliary contacts
1	4 162 80		90 kW	24 V $\sim/\equiv$	2 NO + 2 NC
1	4 162 86		90 kW	100-240 V $\sim/\equiv$	2 NO + 2 NC
1	4 162 89		90 kW	380-450 V $\sim$	2 NO + 2 NC
			<b>225 A (AC3) - 275 A (AC1)</b>		
1	4 162 90		132 kW	24 V $\sim/\equiv$	2 NO + 2 NC
1	4 162 96		132 kW	100-240 V $\sim/\equiv$	2 NO + 2 NC
1	4 162 99		132 kW	380-450 V $\sim$	2 NO + 2 NC

Pack	Cat.Nos		CTX <sup>3</sup> 400		
			With integrated auxiliary contacts		
			<b>265 A (AC3) - 300 A (AC1)</b>		
	Screw terminals		3-phase motor 400/415 V	Control Voltage	Integrated auxiliary contacts
1	4 163 06		147 kW	100-240 V $\sim/\equiv$	2 NO + 2 NC
1	4 163 09		147 kW	380-450 V $\sim$	2 NO + 2 NC
			<b>330 A (AC3) - 350 A (AC1)</b>		
1	4 163 16		160 kW	100-240 V $\sim/\equiv$	2 NO + 2 NC
1	4 163 19		160 kW	380-450 V $\sim$	2 NO + 2 NC
			<b>400 A (AC3) - 450 A (AC1)</b>		
1	4 163 26		200 kW	100-240 V $\sim/\equiv$	2 NO + 2 NC
1	4 163 29		200 kW	380-450 V $\sim$	2 NO + 2 NC

Pack	Cat.Nos		CTX <sup>3</sup> 800		
			With integrated auxiliary contacts		
			<b>500 A (AC3) - 580 A (AC1)</b>		
	Screw terminals		3-phase motor 400/415 V	Control Voltage	Integrated auxiliary contacts
1	4 163 36		265 kW	200-240 V $\sim/\equiv$	2 NO + 2 NC
1	4 163 39		265 kW	380-450 V $\sim$	2 NO + 2 NC
			<b>630 A (AC3) - 660 A (AC1)</b>		
1	4 163 46		330 kW	200-240 V $\sim/\equiv$	2 NO + 2 NC
1	4 163 49		330 kW	380-450 V $\sim$	2 NO + 2 NC
			<b>800 A (AC3) - 900 A (AC1)</b>		
1	4 163 56		440 kW	200-240 V $\sim/\equiv$	2 NO + 2 NC
1	4 163 59		440 kW	380-450 V $\sim$	2 NO + 2 NC



















Add-on auxiliary contact blocks **p. 186**



Other control voltage, spare coils for CTX<sup>3</sup> 3-pole contactors, **please, consult us**

### 3-pole contactors CTX<sup>3</sup> and thermal overload relays RTX<sup>3</sup>

#### technical characteristics

																												
Contactor		CTX <sup>3</sup> mini	CTX <sup>3</sup> 22	CTX <sup>3</sup> 40	CTX <sup>3</sup> 65	CTX <sup>3</sup> 100	CTX <sup>3</sup> 150	CTX <sup>3</sup> 225	CTX <sup>3</sup> 400	CTX <sup>3</sup> 800																		
Size		-	2	3	4	5	6	7	8	9																		
Terminals type		screw	screw	screw	screw or cage	screw or cage	screw or cage	screw	screw	screw																		
Rated operational voltage, U <sub>e</sub>		690 V	690 V	690 V	690 V	690 V	690 V	690 V	690 V	690 V																		
Rated insulation voltage, U <sub>i</sub>		690 V	690 V	1000 V	1000 V	1000 V	1000 V	1000 V	1000 V	1000 V																		
Rated frequency		50/60 Hz	50/60 Hz	50/60 Hz	50/60 Hz	50/60 Hz	50/60 Hz	50/60 Hz	50/60 Hz	50/60 Hz																		
Rated impulse withstand voltage, U <sub>imp</sub>		6 kV	6 kV	8 kV	8 kV	8 kV	8 kV	8 kV	8 kV	8 kV																		
Max. operating rate in operation cycle per hour (AC-3)		1800	1800	1800	1800	1800	1200	1200	1200	1200																		
Durability in millions of operations	Mechanical	12	15	12	12	12	5	5	5	2.5																		
	Electrical	1	2.5	2	2	2	1	1	1	0.5																		
Current and power	Type	6 A	9 A	12 A	16 A	9 A	12 A	18 A	22 A	32 A	40 A	50 A	65 A	75 A	85 A	100 A	130 A	150 A	185 A	225 A	265 A	330 A	400 A	500 A	630 A	800 A		
	AC-1	Thermal current (A)	20	20	20	20	25	25	40	40	50	60	70	100	110	135	160	160	210	230	275	300	350	450	580	660	900	
		200/240 V (kW)	1.5	2.2	3	4	2.5	3.5	4.5	5.5	7.5	11	15	18.5	22	25	30	37	45	55	75	80	90	125	147	190	220	
	AC-3	(A)	7	9	12	15	11	13	18	22	32	40	55	65	75	85	105	130	150	185	225	265	330	400	500	630	800	
		380/440 V (kW)	2.2	4	5.5	7.5	4	5.5	7.5	11	15	18.5	22	30	37	45	55	60	75	90	132	147	160	200	265	330	440	
	500/550 V (kW)	(A)	3	3.7	4	5.5	4	7.5	7.5	15	18.5	22	30	33	37	45	55	60	70	110	132	147	160	225	265	330	500	
		690 V (kW)	3	4	4	4	4	7.5	7.5	15	18.5	22	30	33	37	45	55	55	55	110	140	160	200	250	300	400	500	
	1000 V (kW)	(A)	4	5	5	5	5	9	9	18	20	23	28	35	42	45	65	60	60	120	150	185	225	300	380	420	630	
		(A)	-	-	-	-	-	-	-	-	22	22	30	30	37	27	37	75	75	132	132	147	147	147	220	220	220	
	UL rating 50/60 Hz	Continuous current (A)		20	20	20	20	25	25	40	40	50	60	70	100	110	135	160	160	210	230	275	300	350	450	580	660	900
Single phase		110/220 V (HP)	1/2	1/2	1	-	0.5	0.75	1	2	2	3	3	5	5	7.5	10	10	15	15	15	15	-	-	-	-	-	-
		220/240 V (HP)	1	1.5	2	-	1.5	2	3	3	5	7.5	10	15	15	15	20	20	25	30	40	40	-	-	-	-	-	
Three phase		200/208 V (HP)	-	-	-	-	2	3	5	7.5	7.5	15	20	25	25	30	30	40	40	60	60	75	100	125	150	200	200	
		220/240 V (HP)	1.5	3	3	-	3	5	7.5	10	10	15	25	30	30	40	40	40	50	60	75	100	125	150	200	250	300	
		440/480 V (HP)	3	5	7.5	-	5	7.5	10	15	20	30	40	50	50	60	75	75	100	125	150	200	250	300	400	500	600	
550/600 V (HP)		3	5	7.5	-	7.5	10	15	20	25	30	50	60	60	75	75	75	75	125	150	200	250	300	400	500	600		
NEMA size		00	00	00	0	00	00	0	1	1	1	2	2	2	3	3	3	4	4	4	4	5	5	5	6	6	7	
Weight and size	AC control	Weight (kg)	0.17				0.34				0.4		0.9			1.6			2.4		5.4		9.2			22.4		
		Size (W x H x D) (mm)	45 x 58 x 57				45 x 73.5 x 87.4				45 x 83 x 90		55 x 106 x 119			70 x 140 x 135.8			95 x 158 x 130.3		138 x 203 x 185.1		163 x 243 x 204.4			285 x 312 x 245.3		
	DC control	Weight (kg)	0.23				0.41				0.6		1.2			2.6			2.4		5.4		9.2			22.4		
		Size (W x H x D) (mm)	45 x 58 x 69				45 x 73.5 x 103.6				45 x 83 x 117.1		55 x 106 x 146.4			70 x 140 x 172.3			95 x 158 x 130.3		138 x 203 x 185.1		163 x 243 x 204.4			285 x 312 x 245.3		
Integrated auxiliary contacts		1 NO or 1 NC				1 NO + 1 NC				2 NO + 2 NC		2 NO + 2 NC			2 NO + 2 NC			2 NO + 2 NC		2 NO + 2 NC		2 NO + 2 NC			2 NO + 2 NC			
Add on auxiliary block	Side mounting	Yes				Yes				Yes		Yes			Yes			Yes		Yes		Yes			Yes			
	Front mounting	Yes				Yes				Yes		Yes			Yes			Yes		No		No			No			
Thermal overload relay		RTX <sup>3</sup> mini	RTX <sup>3</sup> 40	RTX <sup>3</sup> 40	RTX <sup>3</sup> 65	RTX <sup>3</sup> 100	RTX <sup>3</sup> 150	RTX <sup>3</sup> 225	RTX <sup>3</sup> 400	RTX <sup>3</sup> 800																		
																												
Terminals type	Standard RTX <sup>3</sup>	-				screw				screw		screw			screw		-		-		-			-				
	Differential RTX <sup>3</sup>	screw				screw				screw		cage			cage		screw		screw		screw			screw				
Rated operational voltage, U <sub>e</sub>		690 V				690 V				690 V		690 V			690 V		690 V		690 V		690 V			690 V				
Rated insulation voltage, U <sub>i</sub>		690 V				690 V				690 V		690 V			690 V		690 V		690 V		690 V			690 V				
Rated impulse withstand voltage, U <sub>imp</sub>		6 kV				6 kV				6 kV		6 kV			6 kV		6 kV		6 kV		6 kV			6 kV				
Trip class		10 A				10 A				10 A		10 A			10 A		10 A		10 A		10 A			10 A				
Setting		0.1 to 16 A				0.1 to 40 A				0.1 to 40 A		9 to 65 A			18 to 100 A			45 to 150 A		65 to 240 A		85 to 400 A			200 to 800 A			
Weight and size	Weight (kg)	0.1				0.17				0.17		0.31/0.33			0.48/0.5			0.67		2.5		2.6			11.5			
	Size (W x H x D) (mm)	45 x 73 x 63				45 x 75 x 90				45 x 75 x 90		55 x 81 x 100			70 x 97 x 110			95 x 109 x 113		147 x 141 x 184		151 x 171 x 198			360 x 530 x 212			

### 3-pole contactors CTX<sup>3</sup>

dimensions

**CTX<sup>3</sup> 22**

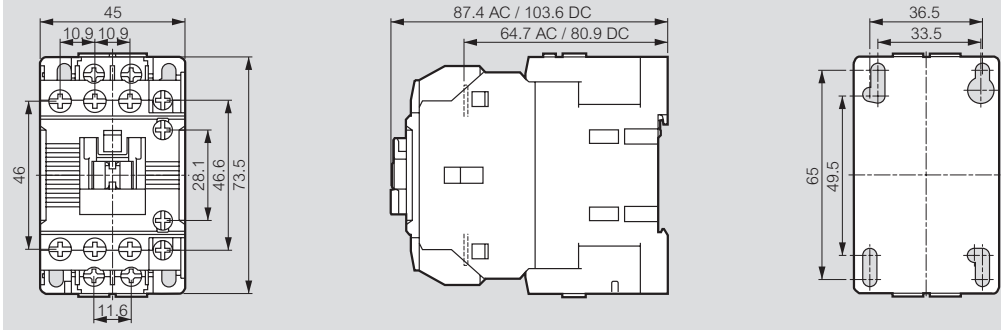

**CTX<sup>3</sup> 150**

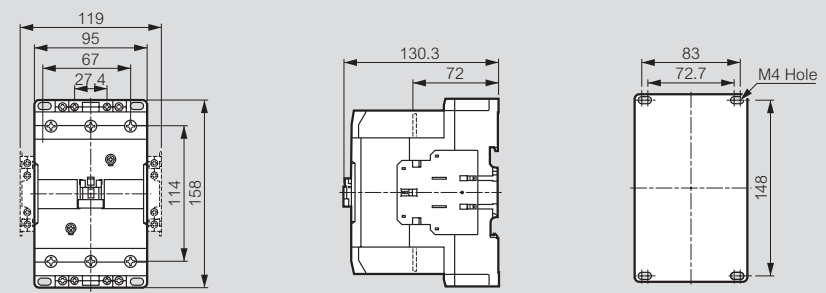

**CTX<sup>3</sup> 40**

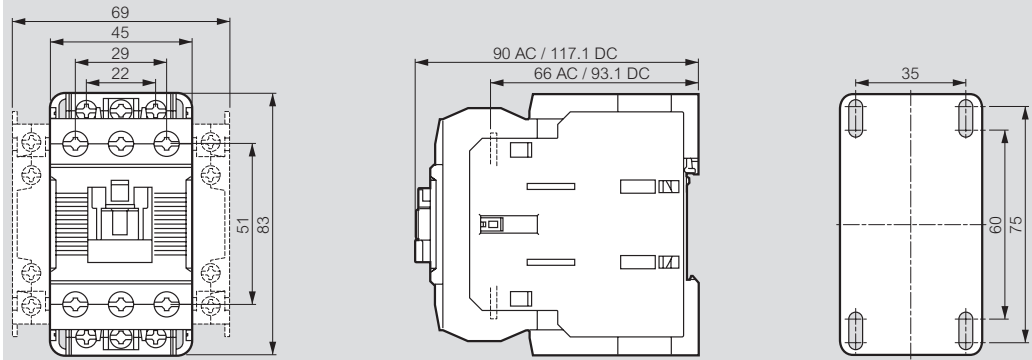

**CTX<sup>3</sup> 225**

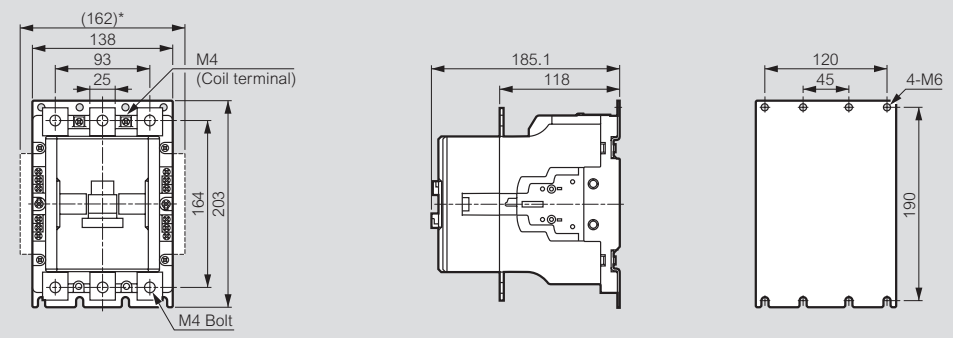

**CTX<sup>3</sup> 65**

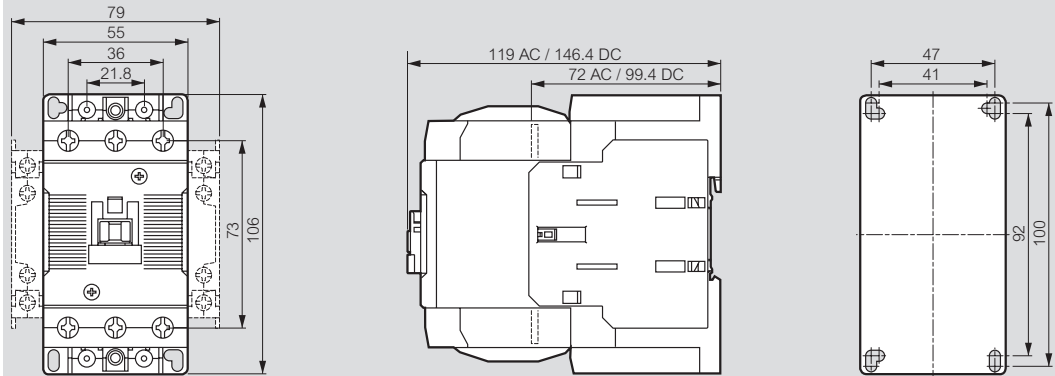

**CTX<sup>3</sup> 400**

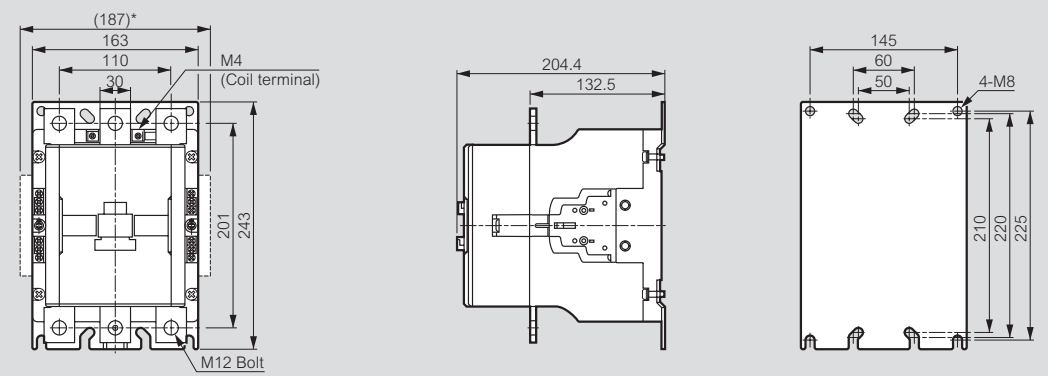

**CTX<sup>3</sup> 100**

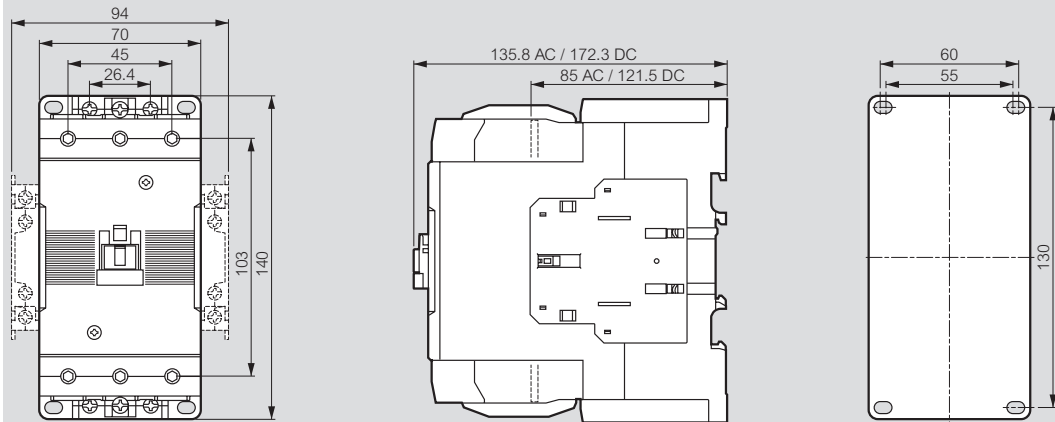

**CTX<sup>3</sup> 800**

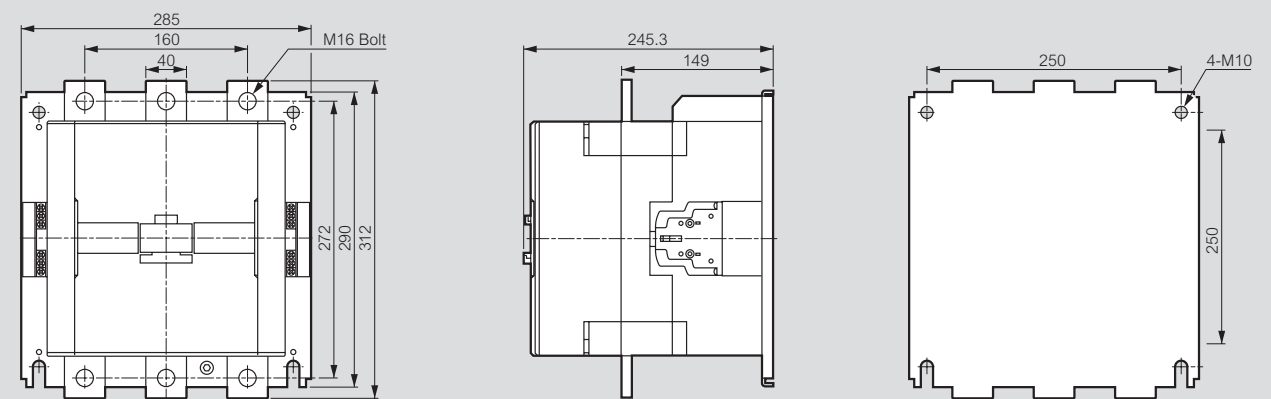

# Industrial Contactors CTX<sup>3</sup> 3P 185A - 800A

Cat. N°(s) : 4 162 80..82/86/89..90/92/96/99  
4 163 06/09/16/19/26/29/36/39/46/49/56/59



CONTENTS	PAGES
1. Description - Use .....	1
2. Range .....	1
3. Overall dimensions.....	1
4. Installation - Connection.....	2
5. General characteristics .....	3
6. Conformities and approvals.....	23
7. Auxiliaries and accessories .....	24

## 1. DESCRIPTION - USE

. Remote control of a load by the mean of a switch.

### Symbol:

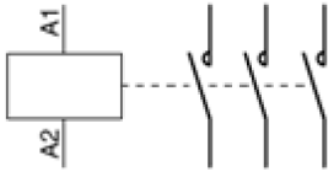

### Technology :

. Electromagnetic contactor.

## 2. RANGE

### Number of Poles:

. Triple pole (3P).

### Rated current Ie:

. 185A, 225A, 265A, 330A, 400A, 500A, 630A, 800A.

### Rated Voltage / Frequency:

. 690 V, 50 / 60 Hz with standard tolerances.

### Rated control circuit voltage Uc:

- . 24 [V~ / =].
- . 48 [V~ / =].
- . 100 - 240 [V~].
- . 100 - 220 [V=].
- . 200 - 240 [V~].
- . 200 - 220 [V~ / =].
- . 380 - 450 [V~].

## 3. OVERALL DIMENSIONS (continued)

### CTX<sup>3</sup> 225:

. CTX<sup>3</sup> Contactor 3P 185A / 225A  
- Type AC and Type DC: 2NO + 2NC Auxiliary contacts

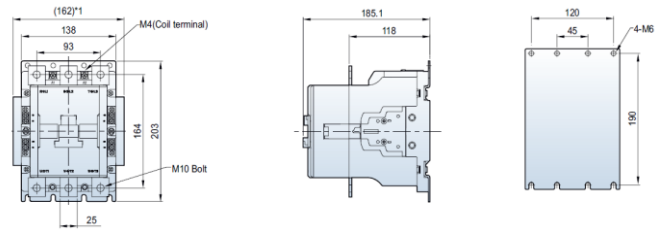

### CTX<sup>3</sup> 400:

. CTX<sup>3</sup> Contactor 3P 265A / 330A / 400A  
- Type AC and Type DC: 2NO + 2NC Auxiliary contacts

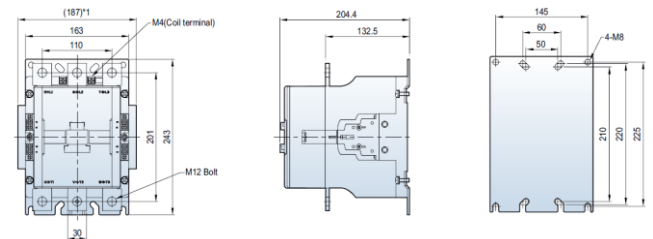

### CTX<sup>3</sup> 800:

. CTX<sup>3</sup> Contactor 3P 500A / 630A / 800A  
- Type AC and Type DC: 2NO + 2NC Auxiliary contacts

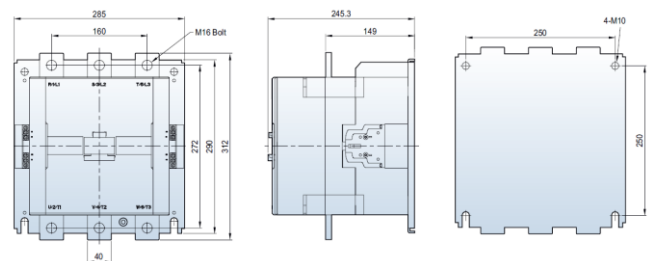

# Industrial Contactors

## CTX<sup>3</sup> 3P 185A - 800A

Cat. N°(s) : 4 162 80..82/86/89..90/92/96/99  
4 163 06/09/16/19/26/29/36/39/46/49/56/59

### 4. INSTALLATION - CONNECTION

#### Fixing:

- . Mounting on plate.

#### Operating position:

- .  $\pm 30$  [°] possible, in relation to normal vertical mounting plane.

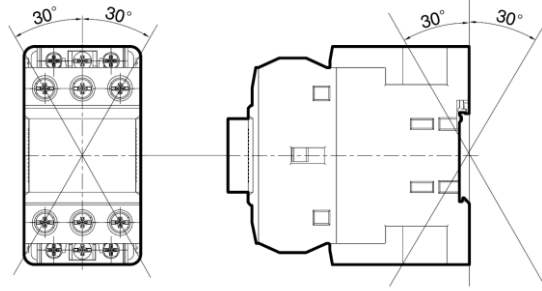

#### Supply:

- . Either from the top or the bottom.

#### Size of wire and tightening torque:

Frame	Wire type	Main Terminal Size							Torque			
			(AWG / mm <sup>2</sup> )						mm(max)	[lb-in]	[Nm]	[kgf·cm]
CTX <sup>3</sup> 225 - 185A		M10	-	1~4/0 / 50~95	1~4/0 / 50~95	-	-	25	130	14.7	150	
CTX <sup>3</sup> 225 - 225A			-	1/0~300 / 50~150	1/0~300 / 50~150	-	-					
CTX <sup>3</sup> 400 - 265A		M12	-	3/0~500 / 95~240	3/0~500 / 95~240	-	-	30	200	22.6	230	
CTX <sup>3</sup> 400 - 330A			-	4/0~500 / 95~240	4/0~500 / 95~240	-	-					
CTX <sup>3</sup> 400 - 400A			-	350~700 / 185~185 × 2	350~700 / 185~185 × 2	-	-					
CTX <sup>3</sup> 800 - 500A		M16	-	350~800 / 185~240 × 2	350~800 / 185~240 × 2	-	-	40	500	26.5	270	
CTX <sup>3</sup> 800 - 630A			-	600~2000	-	-	-					
CTX <sup>3</sup> 800 - 800A			-	1700~Busbar	-	-	-					
CTX <sup>3</sup> 225~800 Aux/Coil		M4	16~10 / 1.25~5.5	16~10 / 1.25~5.5	16~10 / 1.25~5.5	-	-	7.6	15	1.75	18	

#### Type of conductors:

- . Conductor type = 75°C Cu stranded wire.

#### Tools required:

- . Pozidriv N°2 screwdriver recommended.
- . Flat screwdriver Ø5 to Ø6 [mm] Maximum.
- . Flat spanner for M10 bolt (CTX<sup>3</sup> 225).
- . Flat spanner for M12 bolt (CTX<sup>3</sup> 400).
- . Flat spanner for M16 bolt (CTX<sup>3</sup> 800).

**5. GENERAL CHARACTERISTICS**

**Front side:**

. By dark grey laser or pad printing:

- Brand: Legrand
- Range: CTX + frame
- Rated current (in A)
- Marking power terminals
- Marking auxiliary terminals when required

**CTX<sup>3</sup> 225:** (Example of marking)

. CTX<sup>3</sup> Contactor 3P 185A / 225A

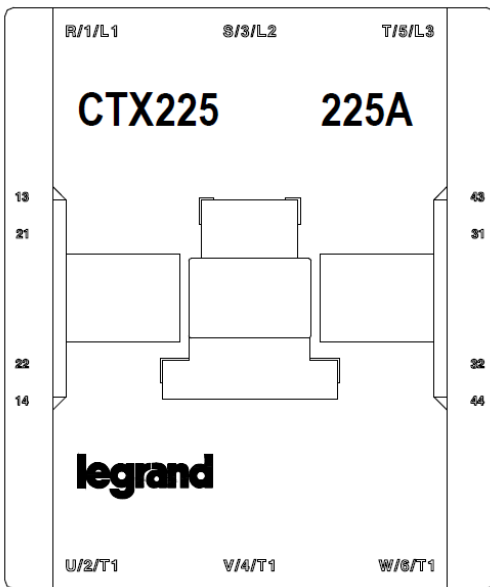

**Left side:**

. By identification label (referring to IEC standard)

**5. GENERAL CHARACTERISTICS (continued)**

**Upper side:** when applicable

. By dark grey laser or pad printing:

- Control voltage (Uc)
- Frequency (f)
- Terminals identification

**Lower side:** when applicable

. By dark grey laser or pad printing:

- Control voltage (Uc)
- Frequency (f)
- Terminals identification

**Rated operational voltage:**

. Ue = 690 [V] for all products.

**Frequency limit:**

. 25/400 [Hz].

**Degree of pollution:**

. 3, in accordance with IEC / EN 60 947-4-1.

**Rated impulse voltage and rated insulation voltage:**

Type of products	Rated impulse voltage (Uimp)	Rated insulation voltage (Ui)
CTX <sup>3</sup> 225	8 [kV]	1 000 [V]
CTX <sup>3</sup> 400	8 [kV]	1 000 [V]
CTX <sup>3</sup> 800	8 [kV]	1 000 [V]

**Overvoltage category:**

. Category III.

**Mechanical and electrical endurance:**

Type of products	Mechanical endurance (in millions of operations)	Electrical endurance (in millions of operations)	Maxi operating rate in operating cycles per hour (AC3)
CTX <sup>3</sup> 225	5	1	1200
CTX <sup>3</sup> 400 265 [A]	5	1	1200
CTX <sup>3</sup> 400 330 [A]	5	1	1200
CTX <sup>3</sup> 400 400 [A]	2.5	0.5	1200
CTX <sup>3</sup> 800	2.5	0.5	1200



**5. GENERAL CHARACTERISTICS** *(continued)*

**Weight:**

Type of products	AC/DC Control
CTX <sup>3</sup> 225	5.4 [kg]
CTX <sup>3</sup> 400	9.2 [kg]
CTX <sup>3</sup> 800	22.4 [kg]

**Ambient operating temperature:**

. Min. = -5°C. Max. = +55°C (AC type) / +40°C (DC Type).  
(-20% derating up to +65°C, -30% derating up to +70°C)

**Derating of products depending on the ambient temperature:**

		Ambient temperature			
		≤ 40 [°C] ≤ 104 [°F]	≤ 55 [°C] ≤ 131 [°F]	≤ 65 [°C] ≤ 149 [°F]	≤ 70 [°C] ≤ 158 [°F]
CTX <sup>3</sup> 3P 225 - 185A	Operational current (AC1) [A]	230	230	185	165
CTX <sup>3</sup> 3P 225 - 225A		275	275	220	195
CTX <sup>3</sup> 3P 400 - 265A		300	300	240	210
CTX <sup>3</sup> 3P 400 - 330A		350	350	280	245
CTX <sup>3</sup> 3P 400 - 400A		450	450	360	315
CTX <sup>3</sup> 3P 800 - 500A		580	580	465	410
CTX <sup>3</sup> 3P 800 - 630A		660	660	530	465
CTX <sup>3</sup> 3P 800 - 800A		900	900	720	630

**Ambient storage temperature:**

. Min. = -50°C. Max. = +80°C.

**Degree of protection:** (In accordance with IEC 60 529 standard)

. IP20 (with terminal cover unit only).

**Flame resistance:**

. Conforming to UL = V0.  
. Conforming to IEC 695-2-1 = 960 [°C].

**5. GENERAL CHARACTERISTICS** *(continued)*

**Maximum operating altitude:**

. 3000 [m].

**High altitude application:**

. Rated compensation coefficient at altitudes of more than 1000[m]:

Type	ANSI C37 30-1971			BS2692 PT1-1971/IEC Pub.282-1-1985			
	Rated insulation voltage	Rated current flow of current	Surrounding temperature	Voltage resistance test voltage	Rated insulation voltage	Rated current flow current	Temperature rise
1000	1.00	1.00	1.00	1.0	1.0	1.0	1.0
1200	0.98	0.995	0.992	↑ proportional	↑ proportional	↑ proportional	↑ proportional
1500	0.95	0.99	0.980	1.05	0.95	0.99	0.98
1800	0.92	0.985	0.968	↑ proportional	↑ proportional	↑ proportional	↑ proportional
2100	0.89	0.98	0.956				
2400	0.86	0.97	0.944				
2700	0.83	0.965	0.932				
3000	0.80	0.96	0.920				
3600	0.75	0.95	0.896	1.25	0.80	0.96	0.92
4200	0.70	0.935	0.872	/	/	/	/
4800	0.65	0.925	0.848				
5400	0.61	0.91	0.824				
6000	0.56	0.90	0.800				

**Shock resistance:** (1/2 sine wave = 11 [ms])

. Opened = 8 [g].

. Closed = 10 [g].

**Vibration resistance:** (Conforming to IEC68-2-6; 5...300 [Hz])

. Opened = 2 [g].

. Closed = 4 [g].



# Industrial Contactors

## CTX<sup>3</sup> 3P 185A - 800A

Cat. N°(s) : 4 162 80..82/86/89..90/92/96/99  
4 163 06/09/16/19/26/29/36/39/46/49/56/59

### 5. GENERAL CHARACTERISTICS *(continued)*

Control coil characteristics:



FRAME SIZE	CTX <sup>3</sup> 3P 225	CTX <sup>3</sup> 3P 400	CTX <sup>3</sup> 3P 800
Type	185A 225A	265A 330A 400A	500A 630A 800A
<b>AC/DC common coil</b>			
Control voltage [Uc]	24/24	-	-
AC/DC	48/48	-	100/100
AC/DC	100~240/100~220	100~240/100~220	200/200
AC	300	300	300
AC	400	400	400
AC	500	500	500
Voltage limit [Uc]	85~110%		
Pick-up	30~60%		
Drop-out	30~60%		
Coil consumption at 20°C			
AC 230V Inrush [VA]	380	571	1000
50/60Hz Holding [VA]	11.6	14	29
Heat dissipation [W]	4.7	5	7.8
Operating time			
Closing [ms]	70	55	75
Opening [ms]	70	55	75

**Lifetime of the coil supplied permanently:**

. No limit.

### 5. GENERAL CHARACTERISTICS *(continued)*

**Rating:** In accordance with IEC 60 947 and IEC 60 947-4-1

. For Contactor CTX<sup>3</sup> 3P 185~800

- Rated short-time withstand current, (I<sub>cw</sub>)
- Rated making capacity - AC3
- Rated breaking capacity - AC3

Contactor type		CTX <sup>3</sup> 3P 225 - 185[A]	CTX <sup>3</sup> 3P 225 - 225[A]	CTX <sup>3</sup> 3P 400 - 265[A]	CTX <sup>3</sup> 3P 400 - 330[A]	CTX <sup>3</sup> 3P 400 - 400[A]	CTX <sup>3</sup> 3P 800 - 500[A]	CTX <sup>3</sup> 3P 800 - 630[A]	CTX <sup>3</sup> 3P 800 - 800[A]
<b>I<sub>cw</sub></b> Rated short-time withstand current (IEC 60 947)	1 [s] [A]	2000	2500	3500	4000	4600	6000	7000	7500
	10 [s] [A]	1500	1700	2400	3000	4400	5050	6400	7000
	30 [s] [A]	1000	1200	1500	2500	2974	4400	4500	4900
	1 [min] [A]	800	1000	1100	1700	1846	3400	3500	3800
	3 [min] [A]	520	700	800	1000	1313	2000	2200	2500
	10 [min] [A]	350	500	600	620	760	1400	1550	1550
	≥ 15 [min] [A]	320	400	500	553	699	1100	1300	1300

Contactor type		CTX <sup>3</sup> 3P 225 - 185[A]	CTX <sup>3</sup> 3P 225 - 225[A]	CTX <sup>3</sup> 3P 400 - 265[A]	CTX <sup>3</sup> 3P 400 - 330[A]	CTX <sup>3</sup> 3P 400 - 400[A]	CTX <sup>3</sup> 3P 800 - 500[A]	CTX <sup>3</sup> 3P 800 - 630[A]	CTX <sup>3</sup> 3P 800 - 800[A]
<b>According to IEC 60 947-4-1 (AC3)</b>	Rated making capacity	1850	2250	2650	3300	4000	5000	6300	8000
	Rated breaking capacity	1480	1800	2120	2650	3200	4000	5040	6400

**5. GENERAL CHARACTERISTICS** *(continued)*

**Rating:** In accordance with CE (IEC) and UL 508 certifications -  $\theta \leq 55$  [°C]

. For Contactor CTX<sup>3</sup> 3P 225

Contactor type			Rating = 185 [A]		Rating = 225 [A]	
			[kW]	[A]	[kW]	[A]
AC duty	AC3	200 / 240 [V]	55	185	75	225
		380 / 440 [V]	90	185	132	225
		500 / 550 [V]	110	180	132	200
		690 [V]	110	120	140	150
	AC4	200 / 240 [V]	37	150	45	180
		380 / 440 [V]	75	150	90	180
AC1	lth	-	230	-	275	
DC1 duty	2 pole in series	24 [V]	-	180	-	220
		48 [V]	-	180	-	180
		110 [V]	-	150	-	150
	3 pole in series	24 [V]	-	180	-	220
		48 [V]	-	180	-	220
		110 [V]	-	180	-	220
DC 2, 4 duty	2 pole in series	24 [V]	-	180	-	220
		48 [V]	-	150	-	150
		110 [V]	-	120	-	120
	3 pole in series	24 [V]	-	180	-	220
		48 [V]	-	180	-	220
		110 [V]	-	150	-	150

Contactor type		Rating = 185 [A]		Rating = 225 [A]	
		[hp]	[A]	[hp]	[A]
UL Rating (50 / 60 [Hz])	200 / 208 [V]	60	-	60	-
	220 / 240 [V]	60	-	75	-
	440 / 480 [V]	125	-	150	-
	550 / 600 [V]	125	-	150	-
	lth	-	230	-	275

. Wiring diagrams

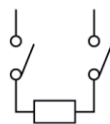

2pole for DC contact

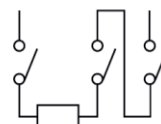

3pole for DC contact

5. GENERAL CHARACTERISTICS (continued)

Rating: In accordance with CE (IEC) and UL 508 certifications -  $\theta \leq 55$  [°C] (continued)

. For Contactor CTX<sup>3</sup> 3P 400

Contactor type		Rating = 265 [A]		Rating = 330 [A]		Rating = 400 [A]		
		[kW]	[A]	[kW]	[A]	[kW]	[A]	
AC duty	AC3	200 / 240 [V]	80	265	90	330	125	400
		380 / 440 [V]	147	265	160	330	200	400
		500 / 550 [V]	147	225	160	280	225	350
		690 [V]	160	185	200	225	250	300
	AC4	200 / 240 [V]	50	200	55	220	75	300
		380 / 440 [V]	102	200	110	220	150	300
AC1	lth	-	300	-	350	-	450	
DC1 duty	2 pole in series	24 [V]	-	220	-	300	-	400
		48 [V]	-	180	-	240	-	240
		110 [V]	-	150	-	200	-	200
	3 pole in series	24 [V]	-	220	-	300	-	400
		48 [V]	-	220	-	300	-	400
		110 [V]	-	220	-	300	-	400
DC 2, 4 duty	2 pole in series	24 [V]	-	220	-	300	-	400
		48 [V]	-	150	-	200	-	200
		110 [V]	-	120	-	150	-	150
	3 pole in series	24 [V]	-	220	-	300	-	400
		48 [V]	-	220	-	280	-	280
		110 [V]	-	150	-	200	-	200

Contactor type		Rating = 265 [A]		Rating = 330 [A]		Rating = 400 [A]	
		[hp]	[A]	[hp]	[A]	[hp]	[A]
UL Rating (50 / 60 [Hz])	200 / 208 [V]	75	-	100	-	125	-
	220 / 240 [V]	100	-	125	-	150	-
	440 / 480 [V]	200	-	250	-	300	-
	550 / 600 [V]	200	-	250	-	300	-
	lth	-	300	-	350	-	450

. Wiring diagrams

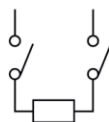

2pole for DC contact

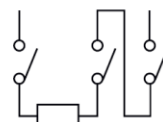

3pole for DC contact

**5. GENERAL CHARACTERISTICS** (continued)

**Rating:** In accordance with CE (IEC) and UL 508 certifications -  $\theta \leq 55$  [°C] (continued)

. For Contactor CTX<sup>3</sup> 3P 800

Contactor type		Rating = 500 [A]		Rating = 630 [A]		Rating = 800 [A]		
		[kW]	[A]	[kW]	[A]	[kW]	[A]	
AC duty	AC3	200 / 240 [V]	147	500	190	630	220	800
		380 / 440 [V]	265	500	330	630	440	800
		500 / 550 [V]	265	400	330	500	500	720
		690 [V]	300	380	400	420	500	630
	AC4	200 / 240 [V]	90	350	110	400	160	630
		380 / 440 [V]	176	350	200	400	300	630
AC1	lth	-	580	-	660	-	900	
DC1 duty	2 pole in series	24 [V]	-	400	-	630	-	800
		48 [V]	-	240	-	630	-	800
		110 [V]	-	200	-	630	-	630
	3 pole in series	24 [V]	-	400	-	630	-	800
		48 [V]	-	400	-	630	-	800
		110 [V]	-	400	-	630	-	800
DC 2, 4 duty	2 pole in series	24 [V]	-	400	-	630	-	800
		48 [V]	-	200	-	630	-	630
		110 [V]	-	150	-	630	-	630
	3 pole in series	24 [V]	-	400	-	630	-	800
		48 [V]	-	280	-	630	-	630
		110 [V]	-	200	-	630	-	630

Contactor type		Rating = 500 [A]		Rating = 630 [A]		Rating = 800 [A]	
		[hp]	[A]	[hp]	[A]	[hp]	[A]
UL Rating (50 / 60 [Hz])	200 / 208 [V]	150	-	200	-	200	-
	220 / 240 [V]	200	-	250	-	300	-
	440 / 480 [V]	400	-	500	-	600	-
	550 / 600 [V]	400	-	500	-	600	-
	lth	-	580	-	660	-	900

. Wiring diagrams

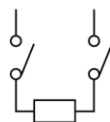

2pole for DC contact

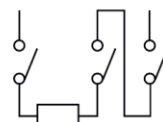

3pole for DC contact

**5. GENERAL CHARACTERISTICS** *(continued)*

**Making and Breaking conditions according to application categories:**

Category	Durability conditions						Occasional operation						
	Making			Breaking			Making			Breaking			
	I/I	U/U	Cos $\theta$ or L/R [ms]	I/I	U/U	Cos $\theta$ or L/R [ms]	I/I	U/U	Cos $\theta$ or L/R [ms]	I/I	U/U	Cos $\theta$ or L/R [ms]	
Magnetic contactors for AC circuit switching													
AC-1	1	1	0.95	1	1	0.95	1.5	1.05	0.8	1.5	1.05	0.8	
AC-2	2.5	1	0.65	2.5	1	0.65	4	1.05	0.65	4	1.05	0.65	
AC-3	$I \leq 17$ [A]	6	1	0.65	1	0.17	0.65	10	1.05	0.45	8	1.05	0.45
	$17 < I \leq 100$ [A]	6	1	0.35	1	0.17	0.35	10	1.05	0.45	8	1.05	0.45
	$I > 100$ [A]	6	1	0.35	1	0.17	0.35	10	1.05	0.35	8	1.05	0.35
AC-4	$I \leq 17$ [A]	6	1	0.65	6	1	0.65	12	1.05	0.45	10	1.05	0.45
	$17 < I \leq 100$ [A]	6	1	0.35	6	1	0.35	12	1.05	0.45	10	1.05	0.45
	$I > 100$ [A]	6	1	0.35	6	1	0.35	12	1.05	0.35	10	1.05	0.35
Magnetic contactors for DC circuit switching													
DC-1	1	1	1	1	1	1	1.5	1.05	1	1.5	1.05	1	
DC-3	2.5	1	2	2.5	1	2	4	1.05	2.5	4	1.05	2.5	
DC-5	2.5	1	7.5	2.5	1	7.5	4	1.05	15	4	1.05	15	

**Operational current when connected in parallel:**

	2 pole in parallel	3 pole in parallel
K	1.6	2.25

5. GENERAL CHARACTERISTICS (continued)

Selection guide for electrical durability:

. For Contactor CTX<sup>3</sup> 3P 185~800[A]

- Category AC-1
- Operational voltage : less than AC 440 [V]
- Power factor : more than 0.95
- It follows when it is applied to resistance load such as heating resistance

Category	Making and Breaking capacity		Electric switching durability	
	Making	Breaking	Making	Breaking
AC-1	1.5 I <sub>e</sub> , 1.1 U <sub>e</sub> Cos Ø 0.95	1.5 I <sub>e</sub> , 1.1 U <sub>e</sub> Cos Ø 0.95	I <sub>e</sub> , U <sub>e</sub> Cos Ø 0.95	I <sub>e</sub> , U <sub>e</sub> Cos Ø 0.95

. With:

- I<sub>e</sub> : Rated operational current
- U<sub>e</sub> : Rated voltage
- Cos Ø : Power factor

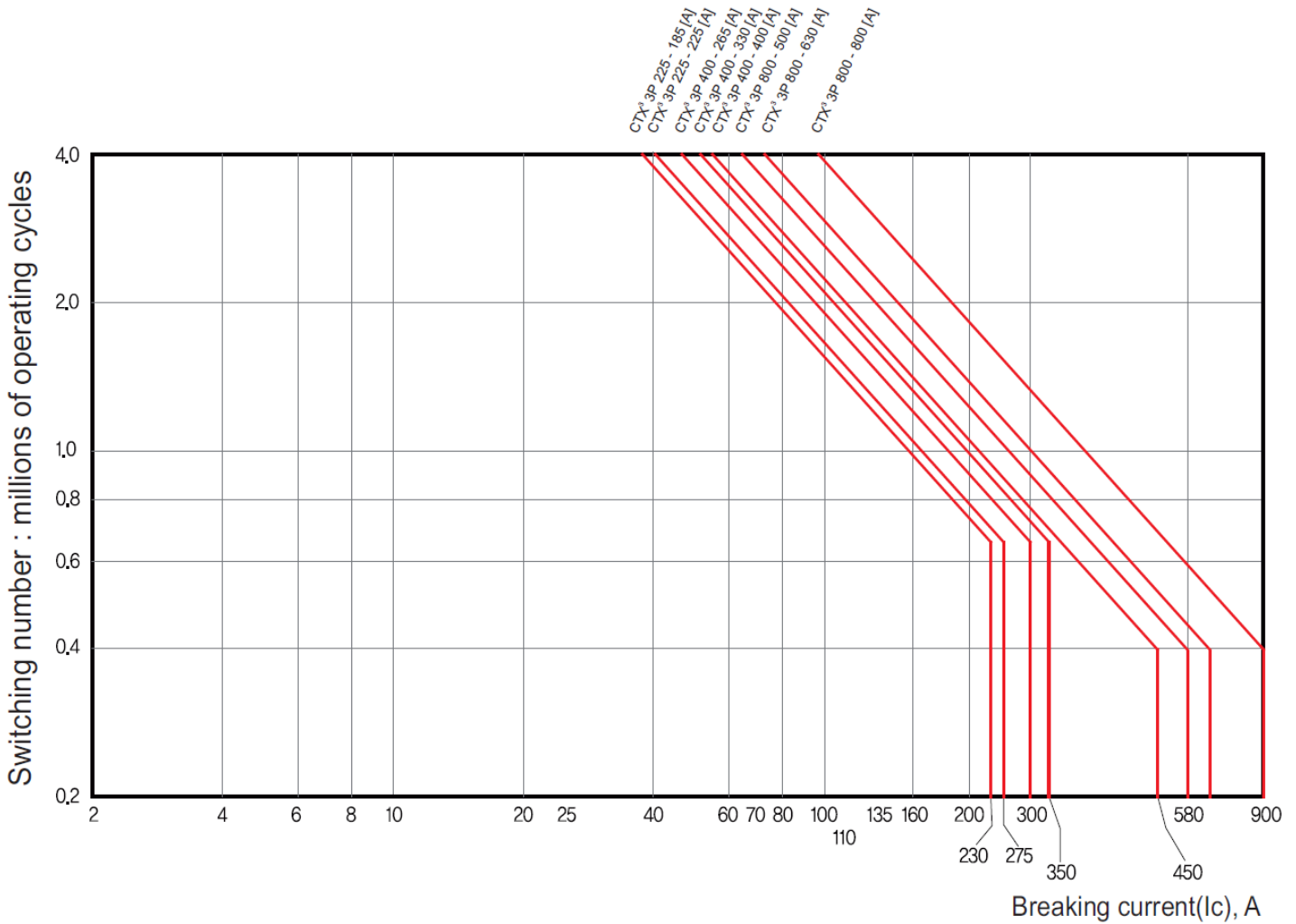



5. GENERAL CHARACTERISTICS (continued)

Selection guide for electrical durability: (continued)

. For Contactor CTX<sup>3</sup> 3P 185~800[A]

- Category AC-3
- Operational voltage : less than 440 [V]

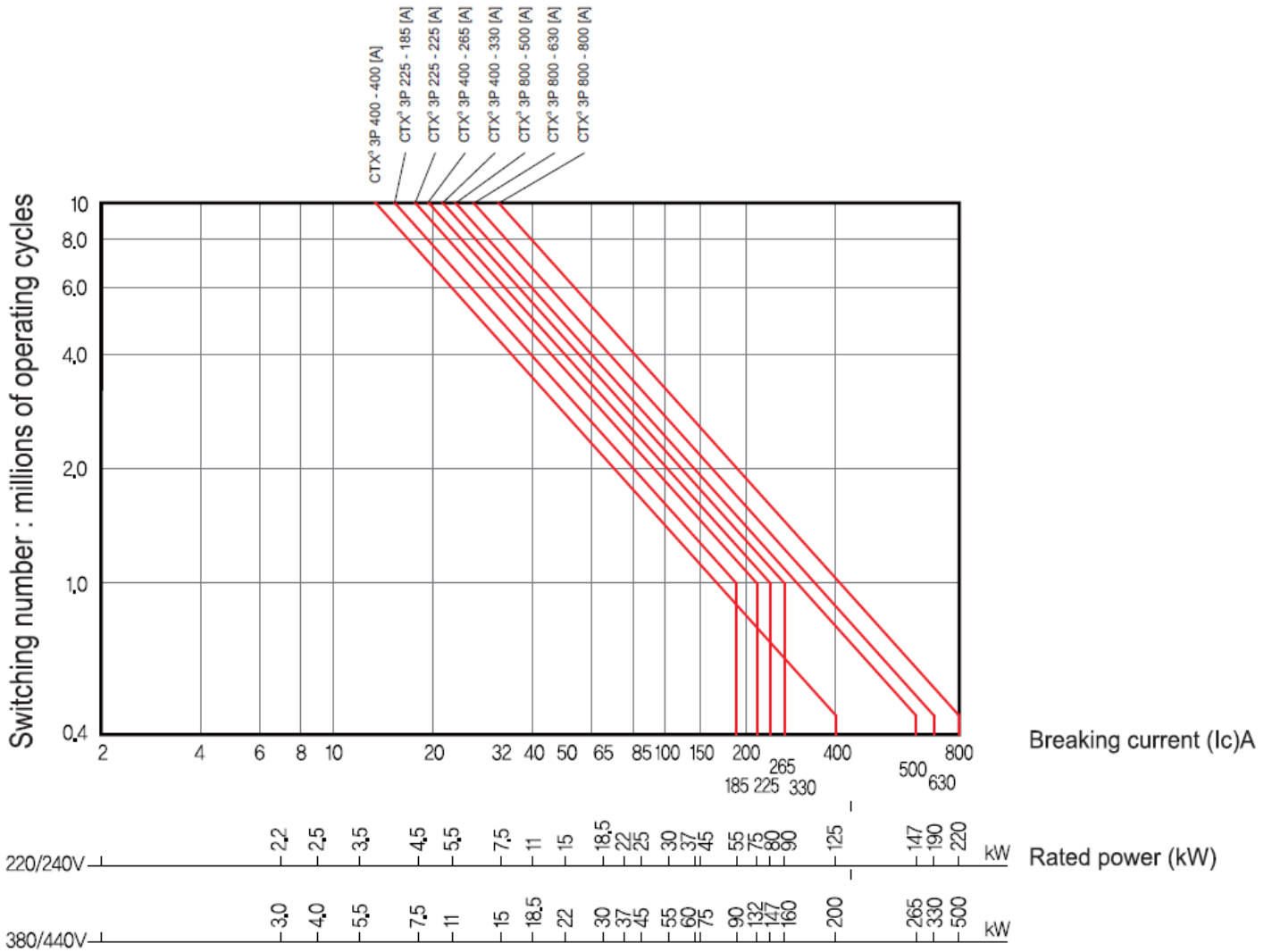

**5. GENERAL CHARACTERISTICS** *(continued)*

**Selection guide for electrical durability:** *(continued)*

. For Contactor CTX<sup>3</sup> 3P 185~800[A]

- Category AC-3
- Operational voltage : less than AC660/690 [V]

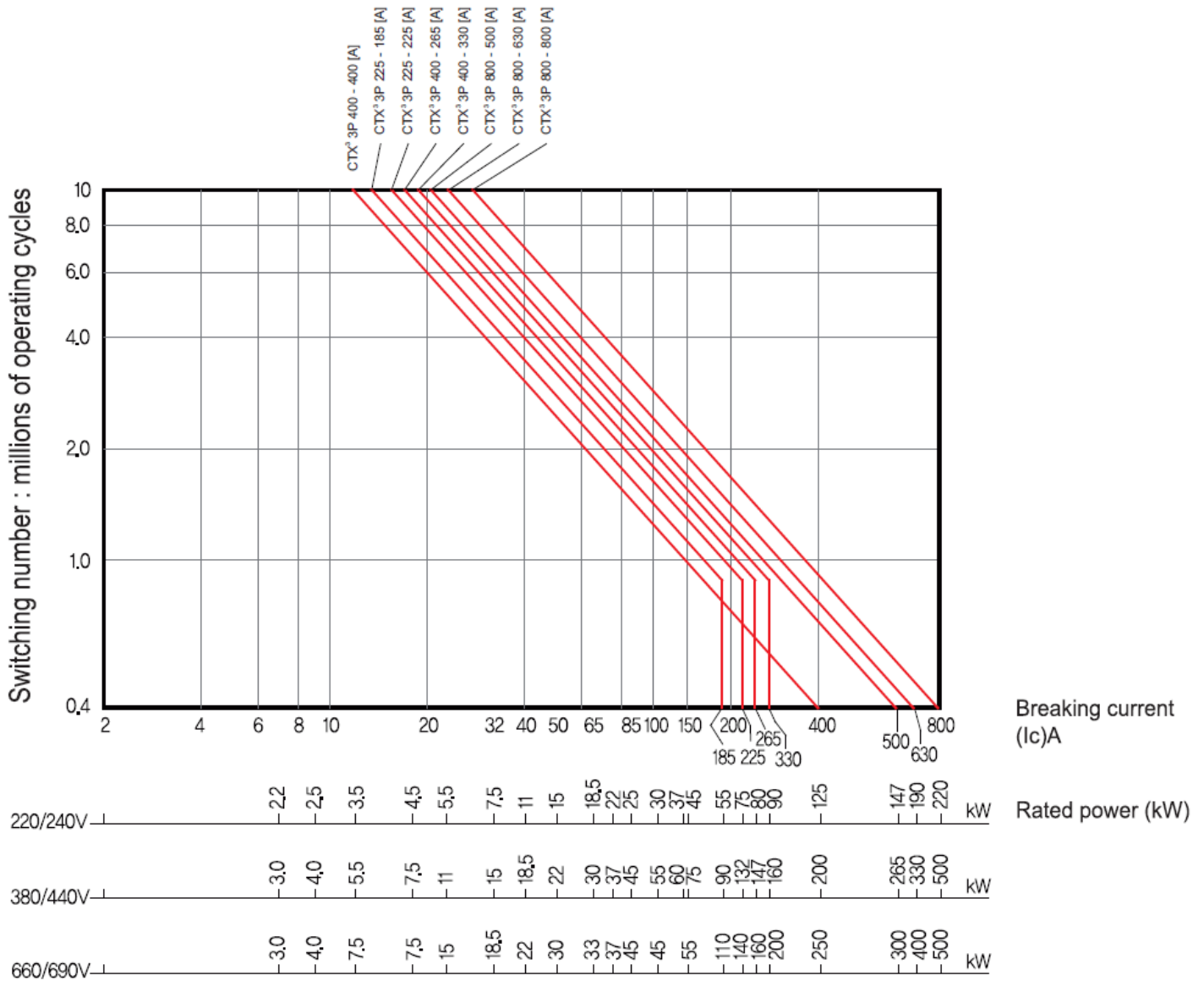

**5. GENERAL CHARACTERISTICS** *(continued)*

**Heating circuit:**

. Switching, control, protection

- Single phase 2 pole switching: (Controlled circuit by 2 poles of contactor)

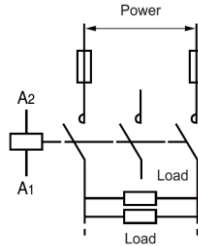

- 3 phases switching: (Controlled circuit by 3 poles of contactor)

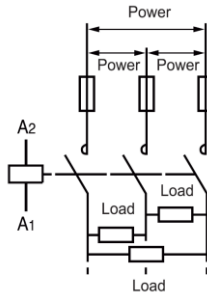

. Component selection according to switching power

- Single phase 2 pole switching: (Controlled circuit by 2 poles of contactor)

Contactor type		CTX <sup>3</sup> 3P 225	CTX <sup>3</sup> 3P 225	CTX <sup>3</sup> 3P 400	CTX <sup>3</sup> 3P 400	CTX <sup>3</sup> 3P 400	CTX <sup>3</sup> 3P 800	CTX <sup>3</sup> 3P 800	CTX <sup>3</sup> 3P 800
		185 [A]	225 [A]	265 [A]	330 [A]	400 [A]	500 [A]	630 [A]	800 [A]
Maximum power [kW]	220 / 240 [V]	48	52	80	75	86	116	155	225
	380 / 415 [V]	83	90	104	130	145	200	368	389
	660 / 690 [V]	130	145	160	200	230	310	415	602

- 3 phases switching: (Controlled circuit by 3 poles of contactor)

Contactor type		CTX <sup>3</sup> 3P 225	CTX <sup>3</sup> 3P 225	CTX <sup>3</sup> 3P 400	CTX <sup>3</sup> 3P 400	CTX <sup>3</sup> 3P 400	CTX <sup>3</sup> 3P 800	CTX <sup>3</sup> 3P 800	CTX <sup>3</sup> 3P 800
		185 [A]	225 [A]	265 [A]	330 [A]	400 [A]	500 [A]	630 [A]	800 [A]
Maximum power [kW]	220 / 240 [V]	82	90	103	130	149	200	268	389
	380 / 415 [V]	143	155	179	225	256	346	464	672
	660 / 690 [V]	220	250	275	345	395	530	710	1030

**5. GENERAL CHARACTERISTICS** *(continued)*

**Switching the primaries of 3 phase LV / LV transformers:** In accordance with IEC 947-4-1 (Table VII b).

. Selection of Contactors

- Maximum ambient temperature : +55 [°C]

Contactor type		CTX <sup>3</sup> 3P 225	CTX <sup>3</sup> 3P 225	CTX <sup>3</sup> 3P 400	CTX <sup>3</sup> 3P 400	CTX <sup>3</sup> 3P 400
		185 [A]	225 [A]	265 [A]	330 [A]	400 [A]
Closing maximum operational power [kVA]	220 / 240 [V]	40	45.8	50.7	64.5	74.8
	380 / 400 [V]	66.6	76.4	84.5	112	130.3
	415 / 440 [V]	73.3	84	92.9	123.2	149.4
	500 [V]	83.3	95.5	105.6	140	169.7
	660 / 690 [V]	115	131.8	142.5	173.5	200.8
Maximum permissible closing peak current - [A]		2900	3300	3800	5000	6300

Contactor type		CTX <sup>3</sup> 3P 800	CTX <sup>3</sup> 3P 800	CTX <sup>3</sup> 3P 800
		500 [A]	630 [A]	800 [A]
Closing maximum operational power [kVA]	220 / 240 [V]	99.8	114.7	179.6
	380 / 400 [V]	166.3	191.2	288.2
	415 / 440 [V]	182.9	210.3	323.1
	500 [V]	207.8	249.4	367.2
	660 / 690 [V]	268.9	329.9	411.11
Maximum permissible closing peak current - [A]		7700	9000	12000

**Transformer sizing:**

. Selection of Transformer power for operation

$$P_{inrush} = 0.8 (\Sigma P_m + \Sigma P_r + P_a)$$

. With:

.  $\Sigma P_m$  = Sum of all contactors holding powers.

.  $\Sigma P_r$  = Sum of all indicators light powers.

.  $P_a$  = Inrush power of the largest contactor.

5. GENERAL CHARACTERISTICS (continued)

Power terminals heat dissipation:

Type CTX <sup>3</sup> 3P	185 [A]	225 [A]	265 [A]	330 [A]	400 [A]	500 [A]	630 [A]	800 [A]
AC-3 Ie 440 [V]	180	250	265	300	400	500	630	800
Power dissipation [W]	11	22	24	32	56	44	69	112

Coordination: Type 2

. According to IEC 60947-4-1

Motor		Circuit-breaker				Contactor	Thermal relay			Test	
Rated power (kW)	Rated current (A)	Type	Rated current (A)	Magnetic threshold (A)	Référence	Type	Type	Setting range (A)	Reference	Conditional short-circuit current I <sub>q</sub> (kA)	Voltage (V)
75	137	DPX <sup>3</sup> 250	160	560 - 1600	4 206 07	CTX <sup>3</sup> 225 185A	RTX <sup>3</sup> 225	100 - 160	4 167 82	50	400
90	164	DPX <sup>3</sup> 250	250	900 - 2500	4 206 09	CTX <sup>3</sup> 225 185A	RTX <sup>3</sup> 225	120 - 185	4 167 83	50	400
110	204	DPX <sup>3</sup> 250	250	900 - 2500	4 206 09	CTX <sup>3</sup> 225 225A	RTX <sup>3</sup> 225	160 - 240	4 167 84	50	400
132	238	DPX <sup>3</sup> 250	250	900 - 2500	4 206 09	CTX <sup>3</sup> 400 265A	RTX <sup>3</sup> 400	200 - 330	4 167 90	50	400
150	262	DPX <sup>3</sup> 630	320	1600 - 3200	4 220 29	CTX <sup>3</sup> 400 330A	RTX <sup>3</sup> 400	200 - 330	4 167 90	50	400
160	282	DPX <sup>3</sup> 630	320	1600 - 3200	4 220 29	CTX <sup>3</sup> 400 330A	RTX <sup>3</sup> 400	260 - 400	4 167 91	50	400
200	350	DPX <sup>3</sup> 630	400	2000 - 3200	4 220 30	CTX <sup>3</sup> 400 400A	RTX <sup>3</sup> 400	260 - 400	4 167 91	50	400
220	387	DPX <sup>3</sup> 630	400	1600 - 3200	4 220 30	CTX <sup>3</sup> 400 400A	RTX <sup>3</sup> 400	260 - 400	4 167 91	50	400
250	440	DPX <sup>3</sup> 630	500	1600 - 3200	4 220 31	CTX <sup>3</sup> 800 630A	RTX <sup>3</sup> 800	400 - 630	4 167 94	50	400

Motor		Circuit-breaker				Contactor	Thermal relay			Test	
Rated power (kW)	Rated current (A)	Type	Rated current (A)	Magnetic threshold (A)	Référence	Type	Type	Setting range (A)	Reference	Conditional short-circuit current I <sub>q</sub> (kA)	Voltage (V)
75	129	DPX <sup>3</sup> 250	160	560 - 1600	4 206 07	CTX <sup>3</sup> 225 185A	RTX <sup>3</sup> 225	100 - 160	4 167 82	50	440
90	157	DPX <sup>3</sup> 250	160	560 - 1600	4 206 07	CTX <sup>3</sup> 225 225A	RTX <sup>3</sup> 225	120 - 185	4 167 83	50	440
110	188	DPX <sup>3</sup> 250	250	900 - 2500	4 206 09	CTX <sup>3</sup> 400 265A	RTX <sup>3</sup> 400	160 - 240	4 167 89	50	440
132	218	DPX <sup>3</sup> 250	250	900 - 2500	4 206 09	CTX <sup>3</sup> 400 265A	RTX <sup>3</sup> 400	160 - 240	4 167 89	50	440
150	244	DPX <sup>3</sup> 630	320	1600 - 3200	4 220 29	CTX <sup>3</sup> 400 400A	RTX <sup>3</sup> 400	200 - 330	4 167 90	50	440
160	260	DPX <sup>3</sup> 630	320	1600 - 3200	4 220 29	CTX <sup>3</sup> 400 400A	RTX <sup>3</sup> 400	200 - 330	4 167 90	50	440
200	330	DPX <sup>3</sup> 630	400	1600 - 3200	4 220 30	CTX <sup>3</sup> 800 630A	RTX <sup>3</sup> 800	260 - 400	4 167 93	50	440
220	355	DPX <sup>3</sup> 630	400	1600 - 3200	4 220 30	CTX <sup>3</sup> 800 630A	RTX <sup>3</sup> 800	260 - 400	4 167 93	50	440
250	405	DPX <sup>3</sup> 630	500	1600 - 3200	4 220 31	CTX <sup>3</sup> 800 800A	RTX <sup>3</sup> 800	400 - 600	4 167 94	50	440

**5. GENERAL CHARACTERISTICS** *(continued)*

**Coordination: Type 2** *(continued)*

. According to IEC 60947-4-1

**Star Delta Motor Starter Type 2 Coordination Table :**

[KW]	[A] at 440 [V]	MCCB Model	Rating - [A]	Nb. of poles	MC Main	MC Delta	MC Star	TOR Model	Rating - [A]	Short circuit current [kA]
75	129	DPX <sup>3</sup> 250A	160	3P	CTX <sup>3</sup> 150	CTX <sup>3</sup> 150	CTX <sup>3</sup> 150	RTX <sup>3</sup> 150	100 - 160	50
90	157	DPX <sup>3</sup> 250A	160	3P	CTX <sup>3</sup> 225	CTX <sup>3</sup> 225	CTX <sup>3</sup> 150	RTX <sup>3</sup> 225	120 - 185	50
110	188	DPX <sup>3</sup> 250A	250	3P	CTX <sup>3</sup> 225	CTX <sup>3</sup> 225	CTX <sup>3</sup> 150	RTX <sup>3</sup> 225	160 - 240	50
132	218	DPX <sup>3</sup> 250A	250	3P	CTX <sup>3</sup> 225	CTX <sup>3</sup> 225	CTX <sup>3</sup> 225	RTX <sup>3</sup> 225	160 - 240	50
160	260	DPX <sup>3</sup> 630A	320	3P	CTX <sup>3</sup> 400	CTX <sup>3</sup> 400	CTX <sup>3</sup> 225	RTX <sup>3</sup> 400	200 - 330	50
200	330	DPX <sup>3</sup> 630A	400	3P	CTX <sup>3</sup> 400	CTX <sup>3</sup> 400	CTX <sup>3</sup> 400	RTX <sup>3</sup> 400	260 - 400	50
220	355	DPX <sup>3</sup> 630A	400	3P	CTX <sup>3</sup> 400	CTX <sup>3</sup> 400	CTX <sup>3</sup> 400	RTX <sup>3</sup> 400	260 - 400	50
250	405	DPX <sup>3</sup> 630A	500	3P	CTX <sup>3</sup> 800	CTX <sup>3</sup> 800	CTX <sup>3</sup> 400	RTX <sup>3</sup> 800	400 - 600	50

**Auto Transformer Motor Starter Type 2 Coordination Table :**

[KW]	[A] at 440 [V]	MCCB Model	Rating - [A]	Nb. of poles	MC Main	MC Delta	MC Star	TOR Model	Rating - [A]	Short circuit current [kA]
75	129	DPX <sup>3</sup> 250A	160	3P	CTX <sup>3</sup> 150	CTX <sup>3</sup> 150	CTX <sup>3</sup> 150	RTX <sup>3</sup> 150	100 - 160	50
90	157	DPX <sup>3</sup> 250A	160	3P	CTX <sup>3</sup> 225	CTX <sup>3</sup> 225	CTX <sup>3</sup> 150	RTX <sup>3</sup> 225	120 - 185	50
110	188	DPX <sup>3</sup> 250A	250	3P	CTX <sup>3</sup> 225	CTX <sup>3</sup> 225	CTX <sup>3</sup> 150	RTX <sup>3</sup> 225	160 - 240	50
132	218	DPX <sup>3</sup> 250A	250	3P	CTX <sup>3</sup> 225	CTX <sup>3</sup> 225	CTX <sup>3</sup> 225	RTX <sup>3</sup> 225	160 - 240	50
160	260	DPX <sup>3</sup> 630A	320	3P	CTX <sup>3</sup> 400	CTX <sup>3</sup> 400	CTX <sup>3</sup> 225	RTX <sup>3</sup> 400	200 - 330	50
200	330	DPX <sup>3</sup> 630A	400	3P	CTX <sup>3</sup> 400	CTX <sup>3</sup> 400	CTX <sup>3</sup> 400	RTX <sup>3</sup> 400	260 - 400	50
220	355	DPX <sup>3</sup> 630A	400	3P	CTX <sup>3</sup> 400	CTX <sup>3</sup> 400	CTX <sup>3</sup> 400	RTX <sup>3</sup> 400	260 - 400	50
250	405	DPX <sup>3</sup> 630A	500	3P	CTX <sup>3</sup> 800	CTX <sup>3</sup> 800	CTX <sup>3</sup> 400	RTX <sup>3</sup> 800	400 - 600	50

**5. GENERAL CHARACTERISTICS** *(continued)*

**Lighting circuit selection guid:**

. Incandescent lamp:

- Incandescent lamp, halogen lamp

Contactor	P [W]	60	75	100	150	200	300	500	750	1000
	I [A]	0.27	0.34	0.45	0.68	0.91	1.36	2.27	3.41	4.55
CTX <sup>3</sup> 225 185A	Maximum number of lamp according to P [W]	700	560	420	280	210	140	84	56	42
CTX <sup>3</sup> 225 225A		767	613	460	307	230	153	92	61	46
CTX <sup>3</sup> 400 265A		883	707	530	353	265	177	106	71	53
CTX <sup>3</sup> 400 330A		1000	800	600	400	300	200	120	80	60
CTX <sup>3</sup> 400 400A		1267	1013	760	507	380	253	152	101	76
CTX <sup>3</sup> 800 500A		1717	1373	1030	687	515	343	206	137	103
CTX <sup>3</sup> 800 630A		2333	1867	1400	933	700	467	280	187	140
CTX <sup>3</sup> 800 800A		3033	2427	1820	1213	910	607	364	243	182

- Mixed lighting

Contactor	P [W]	100	160	250	500	1000
	I [A]	0.45	0.73	1.14	2.27	4.55
CTX <sup>3</sup> 225 185A	Maximum number of lamp according to P [W]	420	263	168	84	42
CTX <sup>3</sup> 225 225A		460	288	184	92	46
CTX <sup>3</sup> 400 265A		530	331	212	106	53
CTX <sup>3</sup> 400 330A		600	375	240	120	60
CTX <sup>3</sup> 400 400A		760	475	304	152	76
CTX <sup>3</sup> 800 500A		1030	644	412	206	103
CTX <sup>3</sup> 800 630A		1400	875	560	280	140
CTX <sup>3</sup> 800 800A		1820	1138	728	364	182



5. GENERAL CHARACTERISTICS (continued)

Lighting circuit selection guid: (continued)

- . Fluorescent lamp with starter:
  - Single fitting

Contactor	Type	Not compensated					With AC compensation (parallel connection)				
	P [W]	20	40	65	80	110	20	40	65	80	110
	I [A]	0.39	0.45	0.70	0.80	1.20	0.17	0.26	0.42	0.52	0.72
	C [μF]	-	-	-	-	-	5	5	7	7	16
CTX <sup>3</sup> 225 185A	Maximum number of lamp according to P [W]	492	426	274	240	160	1128	738	456	368	266
CTX <sup>3</sup> 225 225A		532	462	296	260	172	1224	800	490	400	288
CTX <sup>3</sup> 400 265A		614	532	342	300	200	1412	922	570	462	332
CTX <sup>3</sup> 400 330A		696	604	388	340	226	1600	1046	648	522	378
CTX <sup>3</sup> 400 400A		882	764	490	430	286	2024	1322	818	662	478
CTX <sup>3</sup> 800 500A		1190	1030	652	580	386	2728	1724	1104	892	644
CTX <sup>3</sup> 800 630A		1612	1398	698	786	524	3700	2418	1498	1210	874
CTX <sup>3</sup> 800 800A		2096	1817	907	1022	681	4810	3143	1947	1573	1136

- Twin fitting

Contactor	Type	Not compensated					With AC compensation (parallel connection)				
	P [W]	2x20	2x40	2x65	2x80	2x110	2x20	2x40	2x65	2x80	2x110
	I [A]	2x0.22	2x0.41	2x0.67	2x0.82	2x1.1	2x0.13	2x0.24	2x0.39	2x0.48	2x0.65
CTX <sup>3</sup> 225 185A	Maximum number of lamp according to P [W]	2x436	2x234	2x142	2x116	2x86	2x738	2x400	2x246	2x200	2x146
CTX <sup>3</sup> 225 225A		2x472	2x254	2x154	2x126	2x94	2x800	2x432	2x266	2x216	2x160
CTX <sup>3</sup> 400 265A		2x544	2x292	2x178	2x146	2x108	2x922	2x500	2x308	2x250	2x184
CTX <sup>3</sup> 400 330A		2x618	2x332	2x202	2x166	2x124	2x1046	2x566	2x348	2x282	2x208
CTX <sup>3</sup> 400 400A		2x782	2x420	2x256	2x210	2x156	2x1322	2x716	2x440	2x358	2x264
CTX <sup>3</sup> 800 500A		2x1054	2x566	2x346	2x282	2x210	2x1784	2x966	2x594	2x482	2x356
CTX <sup>3</sup> 800 630A		2x1430	2x766	2x468	2x384	2x286	2x2418	2x1370	2x806	2x654	2x484
CTX <sup>3</sup> 800 800A		2x1859	2x995	2x608	2x499	2x371	2x3143	2x1781	2x1047	2x850	2x629

**5. GENERAL CHARACTERISTICS** *(continued)*

**Lighting circuit selection guide:** *(continued)*

- . Fluorescent lamp without starter:
  - Single fitting

Contactor	Type	Not compensated					With AC compensation (parallel connection)				
	P [W]	20	40	65	80	110	20	40	65	80	110
	I [A]	0.39	0.45	0.70	0.80	1.20	0.17	0.26	0.42	0.52	0.72
	C [µF]	-	-	-	-	-	5	5	7	7	16
CTX <sup>3</sup> 225 185A	Maximum number of lamp according to P [W]	446	348	240	202	130	1010	662	416	336	242
CTX <sup>3</sup> 225 225A		484	378	260	218	148	1094	716	452	364	262
CTX <sup>3</sup> 400 265A		558	438	300	252	170	1252	828	522	420	304
CTX <sup>3</sup> 400 330A		632	494	340	286	194	1462	936	590	476	344
CTX <sup>3</sup> 400 400A		800	524	430	362	246	1810	1186	748	604	434
CTX <sup>3</sup> 800 500A		1078	844	580	488	330	2442	1600	1008	814	586
CTX <sup>3</sup> 800 630A		1462	1144	786	662	448	3310	2168	1366	1104	796
CTX <sup>3</sup> 800 800A		1901	1487	1022	861	582	4303	2818	1776	1435	1035

- Twin fitting

Contactor	Type	Not compensated					With AC compensation (parallel connection)				
	P [W]	2x20	2x40	2x65	2x80	2x110	2x20	2x40	2x65	2x80	2x110
	I [A]	2x0.22	2x0.41	2x0.67	2x0.82	2x1.1	2x0.13	2x0.24	2x0.39	2x0.48	2x0.65
CTX <sup>3</sup> 225 185A	Maximum number of lamp according to P [W]	2x384	2x204	2x126	2x102	2x74	2x686	2x368	2x222	2x180	2x132
CTX <sup>3</sup> 225 225A		2x416	2x220	2x136	2x112	2x80	2x742	2x400	2x242	2x196	2x144
CTX <sup>3</sup> 400 265A		2x480	2x254	2x156	2x128	2x92	2x856	2x462	2x278	2x226	2x166
CTX <sup>3</sup> 400 330A		2x544	2x288	2x178	2x146	2x104	2x970	2x522	2x316	2x256	2x188
CTX <sup>3</sup> 400 400A		2x688	2x366	2x226	2x184	2x132	2x1228	2x662	2x400	2x324	2x238
CTX <sup>3</sup> 800 500A		2x928	2x494	2x304	2x248	2x178	2x1656	2x892	2x540	2x438	2x322
CTX <sup>3</sup> 800 630A		2x1258	2x668	2x414	2x338	2x242	2x2246	2x1210	2x730	2x592	2x436
CTX <sup>3</sup> 800 800A		2x1698	2x901	2x558	2x456	2x326	2x3032	2x1633	2x985	2x799	2x588

5. GENERAL CHARACTERISTICS (continued)

Lighting circuit selection guid: (continued)

. Sodium vapor lamp:

- Low pressure sodium vapor lamps

Contactor	Type	Not compensated							With AC compensation (parallel connection)						
	P [W]	35	55	90	135	150	180	200	35	55	90	135	150	180	200
	I [A]	1.2	1.6	2.4	3.1	3.2	3.3	3.4	0.3	0.4	0.6	0.9	1	1.2	1.3
	C [μF]	-	-	-	-	-	-	-	17	17	25	36	36	36	36
CTX <sup>3</sup> 225 185A	Maximum number of lamp according to P [W]	140	104	70	54	52	50	48	560	420	280	186	168	140	128
CTX <sup>3</sup> 225 225A		152	114	76	58	56	54	54	606	454	302	202	182	152	140
CTX <sup>3</sup> 400 265A		174	130	88	68	66	64	62	700	524	350	232	210	174	162
CTX <sup>3</sup> 400 330A		198	148	98	76	74	72	70	792	594	396	264	238	198	182
CTX <sup>3</sup> 400 400A		250	188	124	96	94	90	88	1002	752	502	334	300	250	208
CTX <sup>3</sup> 800 500A		338	254	168	130	126	122	118	1352	1014	676	450	406	338	312
CTX <sup>3</sup> 800 630A		496	372	248	192	186	180	174	1982	1488	992	660	694	496	458
CTX <sup>3</sup> 800 800A		724	543	362	280	272	263	254	2894	2172	1448	964	1013	724	669

- High pressure sodium vapor lamps

Contactor	Type	Not compensated					With AC compensation (parallel connection)				
	P [W]	3.5	5.5	90	135	150	3.5	55	90	135	150
	I [A]	1.2	1.6	2.4	3.1	3.2	0.3	0.4	0.6	0.9	1
	C [μF]	-	-	-	-	-	17	17	25	36	36
CTX <sup>3</sup> 225 185A	Maximum number of lamp according to P [W]	88	52	34	18	14	200	120	76	42	30
CTX <sup>3</sup> 225 225A		96	56	36	20	16	216	130	82	46	32
CTX <sup>3</sup> 400 265A		110	66	42	24	18	250	150	94	54	38
CTX <sup>3</sup> 400 330A		124	74	48	26	20	282	170	108	60	42
CTX <sup>3</sup> 400 400A		158	94	60	34	24	358	214	136	76	54
CTX <sup>3</sup> 800 500A		214	126	80	46	32	482	290	184	104	74
CTX <sup>3</sup> 800 630A		312	186	118	68	48	708	424	270	152	108
CTX <sup>3</sup> 800 800A		452	270	171	99	70	1027	615	392	220	157

**5. GENERAL CHARACTERISTICS** *(continued)*

**Lighting circuit selection guid:** *(continued)*

. Mercury lamp:

- High pressure mercury vapor lamps

Contactor	Type	Not compensated							With AC compensation (parallel connection)						
	P [W]	50	80	125	250	400	700	1000	35	55	90	135	150	185	200
	I [A]	0.54	0.81	1.20	2.30	4.10	6.80	9.90	0.30	0.45	0.67	1.30	2.30	3.80	5.50
	C [µF]	-	-	-	-	-	-	-	10	10	10	18	25	40	60
CTX <sup>3</sup> 225 185A	Maximum number of lamp according to P [W]	310	206	140	72	40	24	17	560	372	250	128	72	44	30
CTX <sup>3</sup> 225 225A		336	224	152	78	44	26	18	606	404	272	140	78	48	32
CTX <sup>3</sup> 400 265A		388	258	174	90	50	30	20	700	466	312	162	90	54	38
CTX <sup>3</sup> 400 330A		440	294	198	102	58	34	24	792	528	354	182	102	62	42
CTX <sup>3</sup> 400 400A		556	372	250	130	72	44	30	1002	668	448	232	130	78	54
CTX <sup>3</sup> 800 500A		752	500	338	176	96	60	40	1352	902	606	312	176	106	74
CTX <sup>3</sup> 800 630A		1102	734	496	258	144	88	60	1982	1322	888	458	258	156	108
CTX <sup>3</sup> 800 800A		1609	1072	724	377	210	128	88	2894	1930	1296	669	377	228	158

- Metal iodide lamps

Contactor	Type	Not compensated				With AC compensation (parallel connection)			
	P [W]	35	55	90	100	35	55	90	100
	I [A]	1.2	1.6	2.4	3.2	0.3	0.4	0.6	1
	C [µF]	-	-	-	-	17	17	25	36
CTX <sup>3</sup> 225 185A	Maximum number of lamp according to P [W]	66	46	18	8	120	84	32	14
CTX <sup>3</sup> 225 225A		72	50	20	10	130	90	34	16
CTX <sup>3</sup> 400 265A		84	58	22	12	150	104	40	18
CTX <sup>3</sup> 400 330A		94	66	24	14	170	118	44	20
CTX <sup>3</sup> 400 400A		120	84	32	16	214	150	56	26
CTX <sup>3</sup> 800 500A		162	112	42	20	290	202	76	36
CTX <sup>3</sup> 800 630A		238	164	62	30	424	298	112	52
CTX <sup>3</sup> 800 800A		347	239	91	44	619	435	164	76

**6. CONFORMITIES AND APPROVALS**

**Compliance to standards:**

. Standards references: IEC/EN 60 947-1, IEC/EN 60 947-4-1 and UL 508.

. Certifications: CE, UL.

# Industrial Contactors

## CTX<sup>3</sup> 3P 185A - 800A

Cat. N°(s) : 4 162 80..82/86/89..90/92/96/99  
4 163 06/09/16/19/26/29/36/39/46/49/56/59

### 7. AUXILIARIES AND ACCESSORIES

#### Auxiliaries:

#### Rating:

Type	CTX <sup>3</sup> Auxiliary contact side (2P)		
Rated operation voltage (Ue)	600 [V]		
Rated insulation voltage (Ui)	600 [V]		
Rated impulse withstand voltage (Uimp)	6 [kV]		
Rated frequency	50 / 60 [Hz]		
Contact sensibility	Voltage	DC 24 [V]	
	Current	DC 10 [mA]	
Rated thermal current (Ith, AC 12 duty)	16 [A]		
Rated operation current	AC 15 duty	120 [V]	6 [A]
		240 [V]	3 [A]
		380 [V]	1.9 [A]
		480 [V]	1.5 [A]
		500 [V]	1.4 [A]
	DC 13 duty	600 [V]	1.2 [A]
		125 [V]	1.1 [A]
		250 [V]	0.55 [A]
		400 [V]	0.31 [A]
		500 [V]	0.27 [A]
Rated short-time withstand current	600 [V]	0.2 [A]	
	1 [s]	100 [A]	
	0.5 [s]	120 [A]	
Electrical lifetime (mil. operations)	AC 15 duty	0.1 [s]	140 [A]
		220 [V]	0.25
	DC 13 duty	440 [V]	0.25
		220 [V]	0.25
Maximum operating cycles per hour	440 [V]	0.25	
	220 [V]	0.25	
Conductor size (solid, stranded) (Max. number of conducts : 2)	[AWG]	18~10	
	[mm <sup>2</sup> ]	1~2.5	

. Minimum current of Auxiliary contactor is DC 17 [V] 5 [mA].

### 7. AUXILIARIES AND ACCESSORIES (continued)

#### Auxiliaries: (continued)

CTX<sup>3</sup> auxiliary contact side: weight = 0.53 [kg]  
- 1NO + 1NC (cat n° 4 168 59)

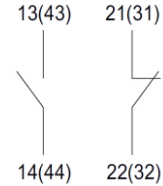

1NO + 1NC

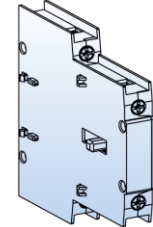

- . Normally closed (NC) auxiliary contact meet the requirements of mirror contacts in IEC 60 947-4-1 (Annex F).
- . For Contactors CTX<sup>3</sup> 3P from 185 to 800 [A].

**7. AUXILIARIES AND ACCESSORIES** *(continued)*

**Auxiliaries:** *(continued)*

**Maximum combination of Auxiliaries:**

Type of products	CTX <sup>3</sup> Auxiliary contact side (2P)
CTX <sup>3</sup> 3P 185A~800A	4 (2 on each side)

**Making Breaking conditions according to application categories:**

. According to IEC/EN 60 947-4-1.

Category	Normal operation						Occasional operation					
	Making			Breaking			Making			Breaking		
	I	U	Cos Ø	I	U	Cos Ø	I	U	Cos Ø	I	U	Cos Ø
AC-14	6 I <sub>e</sub>	U <sub>e</sub>	0.3	I <sub>e</sub>	U <sub>e</sub>	0.3	6 I <sub>e</sub>	1.1 U <sub>e</sub>	0.7	6 I <sub>e</sub>	1.1 U <sub>e</sub>	0.7
AC-15	10 I <sub>e</sub>	U <sub>e</sub>	0.3	I <sub>e</sub>	U <sub>e</sub>	0.3	10 I <sub>e</sub>	1.1 U <sub>e</sub>	0.3	10 I <sub>e</sub>	1.1 U <sub>e</sub>	0.3
DC-13	I <sub>e</sub>	U <sub>e</sub>	6P	I <sub>e</sub>	U <sub>e</sub>	6P	1.1 I <sub>e</sub>	1.1 U <sub>e</sub>	6P	I <sub>e</sub>	1.1 U <sub>e</sub>	6P

. With:

- . I = Inserted and breaking current express symmetric element value such as mean square of DC or AC.
- . I<sub>e</sub> = Rated current.
- . U = Voltage recovery.
- . U<sub>e</sub> = Rated operation voltage.
- . Cos Ø = Power factor.

. The value 6P [W] is based on real axis, P = 50 [W], in other words it indicates the most magnetic load up to maximum limit of 6P = 300 [ms] = L/R. The upper load of this consists of smaller loads in parallel. Therefore 300 [ms] is the maximum limit regardless of rated current value.

**Combined devices:**

. For more information, refer to the technical data sheet of RTX<sup>3</sup>.

. Installation principle:

- Contactor CTX<sup>3</sup> with Thermal Overload Relay RTX<sup>3</sup>

Type of products	Directly mountable Overload relay
CTX <sup>3</sup> 225	RTX <sup>3</sup> 225
CTX <sup>3</sup> 400	RTX <sup>3</sup> 400
CTX <sup>3</sup> 800	RTX <sup>3</sup> 800

### 7. AUXILIARIES AND ACCESSORIES *(continued)*

#### Accessories:

- Mechanical interlock unit CTX<sup>3</sup>:** weight = 0.09 [kg]  
- Mechanical interlock unit CTX<sup>3</sup> 185~400 [A]  
(cat n° 4 168 87)



. For Contactors CTX<sup>3</sup> 3P from 185 to 400 [A].

- Mechanical interlock unit CTX<sup>3</sup>:** weight = 15.2 [kg]  
- Mechanical interlock unit CTX<sup>3</sup> 3P 500~800 [A]  
(cat n° 4 168 88)



. For Contactors CTX<sup>3</sup> 3P from 500 to 800 [A].  
. Mechanical association permitted for equivalent size contactors only.

#### CTX<sup>3</sup> Safety front cover:

- CTX<sup>3</sup> Safety front cover from 185 - 800 [A]  
(cat n° 4 168 41)

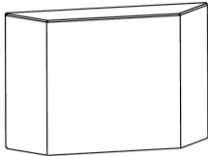

#### Terminal cover unit:

- Terminal cover unit CTX<sup>3</sup> 3P from 185 to 225 [A]  
(cat n° 4 168 42)  
- Terminal cover unit CTX<sup>3</sup> 3P from 265 to 400 [A]  
(cat n° 4 168 43)  
- Terminal cover unit CTX<sup>3</sup> 3P from 500 to 800 [A]  
(cat n° 4 168 44)



### 7. AUXILIARIES AND ACCESSORIES *(continued)*

#### Accessories: *(continued)*

#### Installation software:

- . XL PRO<sup>3</sup>.