

DPX³ 160 thermal magnetic

MCCBs from 16 to 160 A



Electrical characteristics **see e-catalogue**
Dimensions **see e-catalogue**

Can be mounted on rail or on plate in XL³ cabinets and enclosures
MCCBs for switching, control isolation and protection of low voltage electrical lines
Supplied with fixing screws cage terminals 70 mm² max. (flexible cable) or 95 mm² max. rigid cable with accessories
Can be fitted with DPX³ 160 and 250 common auxiliaires and accessories (p. 134)
Conform to IEC 60947-2

Pack	Cat.Nos		
			MCCBs - fixed version
			Thermal adjustable from 0,8 to 1 In Magnetic fixed at 10 In (fixed at 400 A for In 16 A and 25 A)
			Breaking capacity Icu 16 kA (400 V~)
	3P	4P	In (A)
1	4 200 00	4 200 10	16
1	4 200 01	4 200 11	25
1	4 200 02	4 200 12	40
1	4 200 03	4 200 13	63
1	4 200 04	4 200 14	80
1	4 200 05	4 200 15	100
1	4 200 06	4 200 16	125
1	4 200 07	4 200 17	160
			Breaking capacity Icu 25 kA (400 V~)
1	4 200 40	4 200 50	16
1	4 200 41	4 200 51	25
1	4 200 42	4 200 52	40
1	4 200 43	4 200 53	63
1	4 200 44	4 200 54	80
1	4 200 45	4 200 55	100
1	4 200 46	4 200 56	125
1	4 200 47	4 200 57	160
			Breaking capacity Icu 36 kA (400 V~)
1	4 200 80	4 200 90	16
1	4 200 81	4 200 91	25
1	4 200 82	4 200 92	40
1	4 200 83	4 200 93	63
1	4 200 84	4 200 94	80
1	4 200 85	4 200 95	100
1	4 200 86	4 200 96	125
1	4 200 87	4 200 97	160
			Breaking capacity Icu 50 kA (400 V~)
1	4 201 20	4 201 30	16
1	4 201 21	4 201 31	25
1	4 201 22	4 201 32	40
1	4 201 23	4 201 33	63
1	4 201 24	4 201 34	80
1	4 201 25	4 201 35	100
1	4 201 26	4 201 36	125
1	4 201 27	4 201 37	160











Pack	Cat.Nos		
			MCCBs with electronic earth leakage module - fixed version
			Thermal adjustable from 0,8 to 1 In Magnetic fixed at 10 In (fixed at 400 A for In 16 A and 25 A)
			Equipped with earth leakage module with LCD screen Adjustable sensitivity: 0.03 - 0.3 - 1 - 3 A Adjustable tripping: 0 - 0.3 - 1 - 3s (with 0.03 A possible only 0 s)
			Breaking capacity Icu 16 kA (400 V~)
			In (A)
			4P
1	4 200 30		16
1	4 200 31		25
1	4 200 32		40
1	4 200 33		63
1	4 200 34		80
1	4 200 35		100
1	4 200 36		125
1	4 200 37		160
			Breaking capacity Icu 25 kA (400 V~)
1	4 200 70		16
1	4 200 71		25
1	4 200 72		40
1	4 200 73		63
1	4 200 74		80
1	4 200 75		100
1	4 200 76		125
1	4 200 77		160
			Breaking capacity Icu 36 kA (400 V~)
1	4 201 10		16
1	4 201 11		25
1	4 201 12		40
1	4 201 13		63
1	4 201 14		80
1	4 201 15		100
1	4 201 16		125
1	4 201 17		160
			Breaking capacity Icu 50 kA (400 V~)
1	4 201 50		16
1	4 201 51		25
1	4 201 52		40
1	4 201 53		63
1	4 201 54		80
1	4 201 55		100
1	4 201 56		125
1	4 201 57		160

See the video



DPX³

electrical characteristics

																																					
DEVICES	DPX ³ 160 thermal magnetic				DPX ³ 250 thermal magnetic				DPX ³ 250 electronic release				DPX ³ 630 thermal magnetic				DPX ³ 630 electronic release				DPX ³ 1600 thermal magnetic				DPX ³ 1600 electronic release												
Mounting	On rail  or on plate				On rail  or on plate				On rail  or on plate				On plate				On plate				On plate				On plate												
Breaking capacity (kA) (EN 60947-2 and IEC 60947-2)	16 kA	25 kA	36 kA	50 kA	25 kA	36 kA	50 kA	70 kA	25 kA	36 kA	50 kA	70 kA	36 kA	50 kA	70 kA	100 kA	36 kA	50 kA	70 kA	100 kA	36 kA	50 kA	70 kA	100 kA	36 kA	50 kA	70 kA	100 kA									
380/415 V~	16	25	36	50	25	36	50	70	25	36	50	70	36	50	70	100	36	50	70	100	36	50	70	100	36	50	70	100									
220/240 V~	25	35	50	65	40	60	100	100	40	60	100	100	70	100	120	170	70	100	120	170	70	100	120	170	70	100	120	170									
Breaking capacity (% Icu)	100	100	100	100	100	100	100	100	100	100	100	100	100	100	100	100	100	100	100	100	100	100	100	100	100	100	100	100									
Characteristic of use	50/60 Hz												50/60 Hz																								
Nominal frequency	50/60 Hz												50/60 Hz																								
Maximum rated operating voltage Ue	690 V (500 V with integrated e.l.c.bs)				690 V (500 V with integrated e.l.c.bs)				690 V (500 V with integrated e.l.c.bs)				690 V~				690 V~				690 V~				690 V~												
Category of use	A				A				A				A				A: In 630 A - B: In 200 to 400 A				A				B												
Thermal magnetic adjustment	0,8 to 1 In				0,8 to 1 In				-				0.8 to 1 In				-				0.8 to 1 In				-												
Thermal	0,8 to 1 In				0,8 to 1 In				-				0.8 to 1 In				-				0.8 to 1 In				-												
Magnetic	10 In (400 A for 16 A and 25 A sizes)				5 to 10 In				-				5 to 10 In				-				5 to 10 In				-												
Electronic protection adjustment	-				-				-				-				-				-				-												
S2	-				-				-				-				-				-				-												
Sg	-				-				-				-				-				-				-												
Ir = 0.4 - 1 x In	-				-				-				-				-				-				-												
Ir = 3-30 s	-				-				-				-				-				-				-												
I _{sd} = 1.5 - 10 Ir	-				-				-				-				-				-				-												
tsd (I=K) = 0-500 ms	-				-				-				-				-				-				-												
tsd (I≠K) = 0-500 ms	-				-				-				-				-				-				-												
Ig = 0.2 - 1 x In	-				-				-				-				-				-				-												
Ig = 0.1 - 1 s	-				-				-				-				-				-				-												
I _r : 0.4 to 1 In I _{sd} : 1.5 to 10 Ir	-				-				-				-				-				-				-												
Maximum cable cross-section	150 mm ²				150 mm ²				150 mm ²				300 mm ² or 2 x 240 mm ²				300 mm ² or 2 x 240 mm ²				2 or 4 x 240 mm ²				2 or 4 x 240 mm ²												
Rigid cable	150 mm ²				150 mm ²				150 mm ²				300 mm ² or 2 x 240 mm ²				300 mm ² or 2 x 240 mm ²				2 or 4 x 240 mm ²				2 or 4 x 240 mm ²												
Flexible cable	120 mm ²				120 mm ²				120 mm ²				240 mm ² or 2 x 185 mm ²				240 mm ² or 2 x 185 mm ²				2 or 4 x 185 mm ²				2 or 4 x 185 mm ²												
Copper bar and lug width	18 mm				28.5 mm ⁽¹⁾				28.5 mm ⁽¹⁾				32 mm				32 mm				50 mm				50 mm												
Tightening torque	8 Nm				10 Nm				10 Nm				15 Nm				15 Nm				20 Nm				20 Nm												
Nominal current (In) at 40 °C (A)	16	25	40	63	80	100	125	160	100	160	200	250	40	100	160	250	250	320	400	500	630	250	320	400	500	630	500	630	800	1000	1250	500	630	800	1000	1250	1600
In (A)	16	25	40	63	80	100	125	160	100	160	200	250	40	100	160	250	250	320	400	500	630	250	320	400	500	630	500	630	800	1000	1250	500	630	800	1000	1250	1600
Phase	16	25	40	63	80	100	125	160	100	160	200	250	40	100	160	250	250	320	400	500	630	250	320	400	500	630	500	630	800	1000	1250	500	630	800	1000	1250	1600
N	16	25	40	63	80	100	125	160	100	160	200	250	40	100	160	250	250	320	400	500	630	0 - 50 - 100 % of phase value				500	630	800	1000	1250	0 - 50 - 100 % of phase value						
N/2	-	-	-	-	-	-	-	-	-	-	-	-	-	-	-	-	-	250	250	250	320	-				-	-	-	500	630	-						
Magnetic threshold (Im) (A) ⁽²⁾ of DPX ³ thermal magnetic	Fixed				Adjustable				Adjustable				Adjustable																								
In (A)	16	25	40	63	80	100	125	160	100	160	200	250	-	-	-	-	250	320	400	500	630	-				500	630	800	1000	1250	-						
Phase	400	400	400	630	800	1000	1250	1600	125-250	200-400	315-630	500-1000	-	-	-	-	1250-2500	1600-3200	2000-4000	2500-5000	3150-6300	-				2500-5000	3150-6300	4000-8000	5000-10000	6250-12500	-						
N	400	400	400	630	800	1000	1250	1600	125-250	200-400	315-630	500-1000	-	-	-	-	1250-2500	1600-3200	2000-4000	2500-5000	3150-6300	-				2500-5000	3150-6300	4000-8000	5000-10000	6250-12500	-						
N/2	-	-	-	-	-	-	-	-	-	-	-	-	-	-	-	-	-	1000-2000	1250-2500	1600-2500	2000-4000	-				-	-	-	2500-5000	3150-6000	-						
Endurance (cycles)	8000				8000				8000				5000				5000				4000				4000												
Electrical	8000				8000				8000				5000				5000				4000				4000												
Mechanical	25000				20000				20000				10000				20000				10000				10000												
Electronic earth leakage module	without or integrated				without or integrated				without or integrated				downstream e.l.c.bs.				downstream e.l.c.bs.				-				-												
Type	without or integrated				without or integrated				without or integrated				downstream e.l.c.bs.				downstream e.l.c.bs.				-				-												

1: Copper bars only
2: Trip current for 50/60 Hz. For direct current, multiply by 1.5

 For DPX³ magnetic release only, Please, consult us

DPX³ 160

Thermal magnetic and trip-free switches

DPX³-I 160

Reference(s) : 420 000/ 001/ 002/003/ 004/ 005/ 006/ 007/ 010/ 011/ 012/ 013/ 014/ 015/ 016/ 017/ 040/ 041/ 042/ 043/ 044/ 045/ 046/ 047/ 050/ 051/ 052/ 053/ 054/ 055/ 056/ 057/ 080/ 081/ 082/ 083/ 084/ 085/ 086/ 087/ 090/ 091/ 092/ 093/ 094/ 095/ 096/ 097/ 120/ 121/ 122/ 123/ 124/ 125/ 126/ 127/ 130/ 131/ 132/ 133/ 134/ 135/ 136/ 137/ 198/ 199

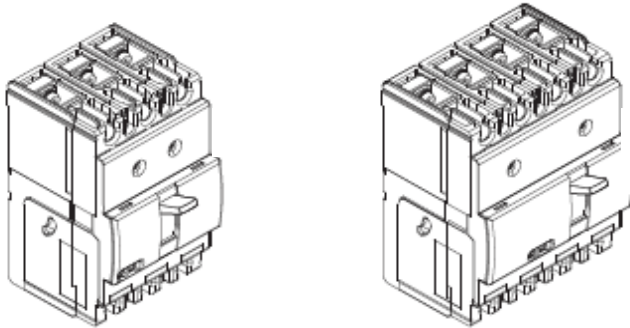

CONTENTS	PAGES
1. USE	1
2. RANGE	1
3. DIMENSIONS	1
3. DIMENSIONS (NEXT)	2
4. ELECTRICAL AND MECHANICAL CHARACTERISTICS	3
5. CONFORMITY	4
6. MARKING	4
7. EQUIPMENTS AND ACCESSORIES	4
8. CURVES	6

1. USE

DPX³ "moulded case" offers optimal solutions to answer protection requirements of tertiary and industrial installations.

2. RANGE

DPX³

In (A)	16 kA		25 kA		36 kA		50 kA	
	3P	4P	3P	4P	3P	4P	3P	4P
16	420000	420010	420040	420050	420080	420090	420120	420130
25	420001	420011	420041	420051	420081	420091	420121	420131
40	420002	420012	420042	420052	420082	420092	420122	420132
63	420003	420013	420043	420053	420083	420093	420123	420133
80	420004	420014	420044	420054	420084	420094	420124	420134
100	420005	420015	420045	420055	420085	420095	420125	420135
125	420006	420016	420046	420056	420086	420096	420126	420136
160	420007	420017	420047	420057	420087	420097	420127	420137

DPX³-I

	3P	4P
160	420 198	420 199

3. DIMENSIONS

3.1 Fixed version

	A	B	C	D	E	F	G	H	I	J	K
160 3P	81	130	72,5	45	62,5	110	27	19	18	74	97
160 4P	108	130	72,5	45	62,5	110	27	19	18	74	97

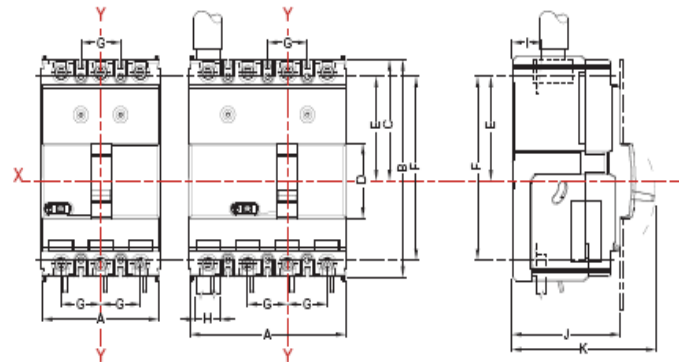
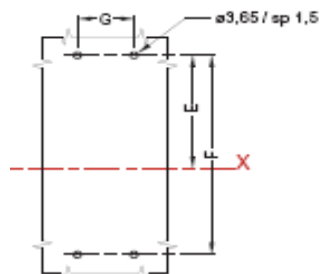

3.2 Fixed version, front terminals

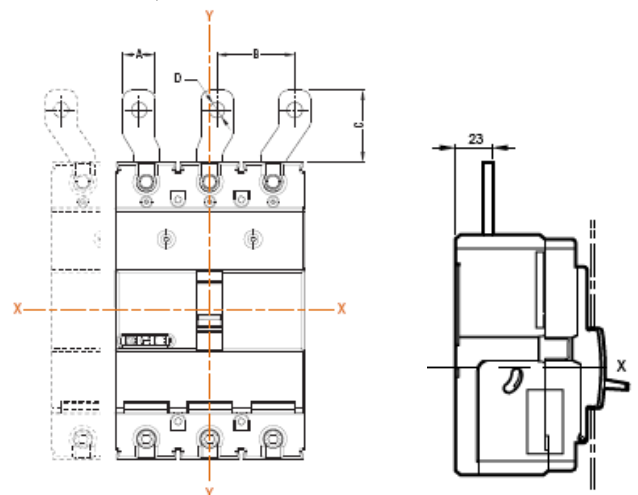

	A	B	C	D
160	17,5	35	41	8,5

DPX³ 160

Thermal magnetic and trip-free switches

DPX³-I 160

Reference(s) : 420 000/ 001/ 002/003/ 004/ 005/ 006/ 007/ 010/ 011/ 012/ 013/ 014/ 015/ 016/ 017/ 040/ 041/ 042/ 043/ 044/ 045/ 046/ 047/ 050/ 051/ 052/ 053/ 054/ 055/ 056/ 057/ 080/ 081/ 082/ 083/ 084/ 085/ 086/ 087/ 090/ 091/ 092/ 093/ 094/ 095/ 096/ 097/ 120/ 121/ 122/ 123/ 124/ 125/ 126/ 127/ 130/ 131/ 132/ 133/ 134/ 135/ 136/ 137/ 198/ 199

3.3 Fixed version, rear terminals

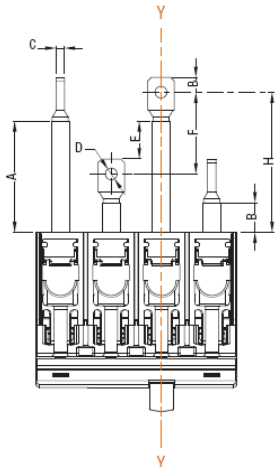

	A	B	C	D	E	F	G	H
160	65,5	21,5	4,5	6,3	19,5	44	11	79

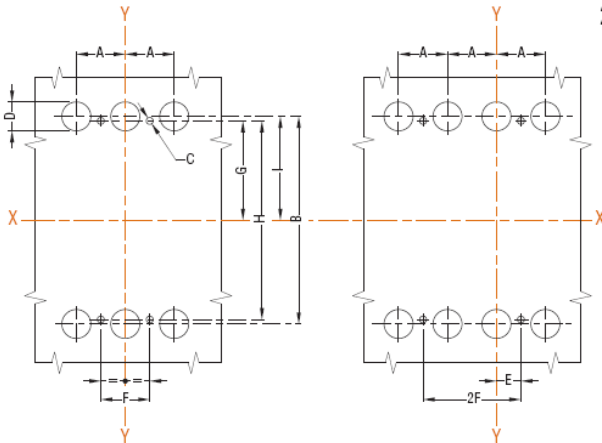

	A	B	C	D	E	F	G	H	I
160	27	115	3,65	16	13,5	27	62,5	110	65

3.4 Fixed version, front motor operator

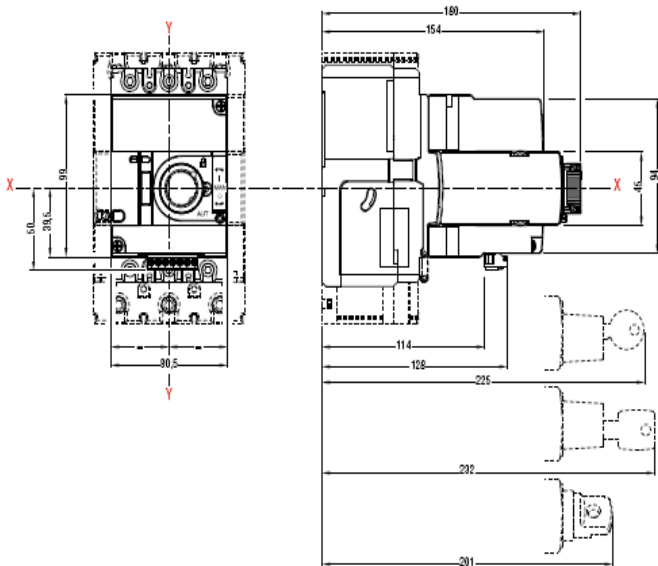

3.5 Fixed version, side motor operator

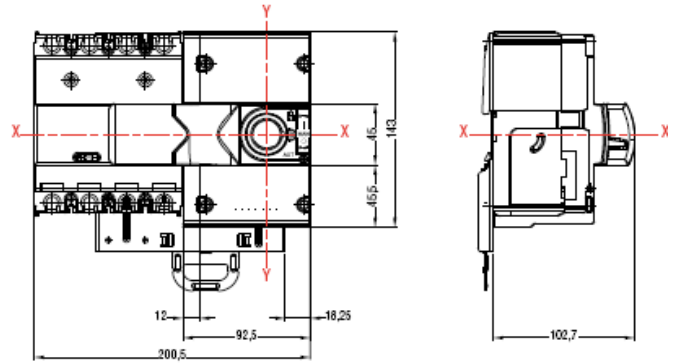

3.6 Plug-in version

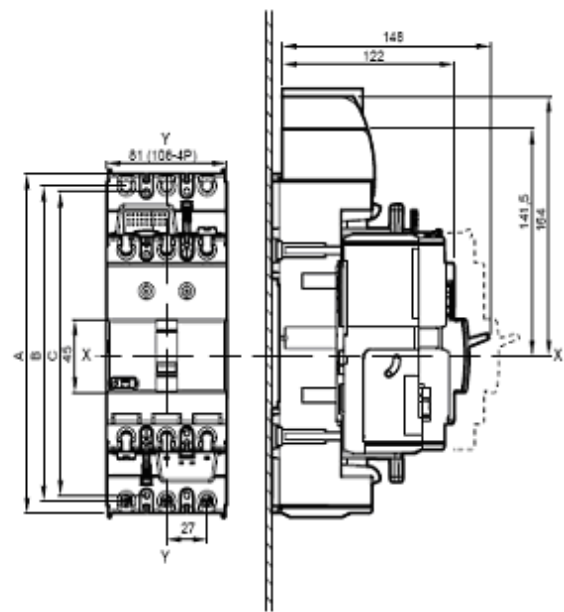

	A	B	C
DPX ³ 160 - 3P	208	193	186
DPX ³ 160 - 4P	238	223	216

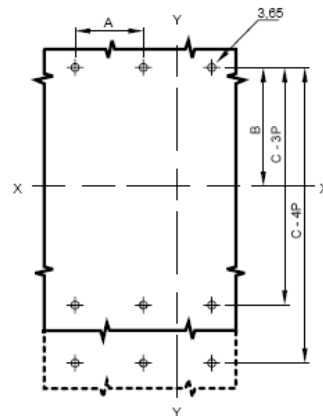

	A	B	C
DPX ³ 160	27	100,5	186

DPX³ 160

Thermal magnetic and trip-free switches

DPX³-I 160

Reference(s) : 420 000/ 001/ 002/003/ 004/ 005/ 006/ 007/ 010/ 011/ 012/ 013/ 014/ 015/ 016/ 017/ 040/ 041/ 042/ 043/ 044/ 045/ 046/ 047/ 050/ 051/ 052/ 053/ 054/ 055/ 056/ 057/ 080/ 081/ 082/ 083/ 084/ 085/ 086/ 087/ 090/ 091/ 092/ 093/ 094/ 095/ 096/ 097/ 120/ 121/ 122/ 123/ 124/ 125/ 126/ 127/ 130/ 131/ 132/ 133/ 134/ 135/ 136/ 137/ 198/ 199

4. ELECTRICAL AND MECHANICAL CHARACTERISTICS

4.1 Breaker technical characteristics

Circuit breaker	DPX ³ 160
Rated current I _n (A)	16-160
Rated insulation voltage U _i (V)	800
Rated operational voltage U _e (V)	690 V (ac) 500 V (dc)
Rated impulse withstand voltage U _{imp} (kV)	8
Ambient temperature (°C)	40
Endurance electrical / mechanical	8000/25000
Utilization category	A
Releases type	thermal-mag
Nominal frequency (Hz)	50-60
Thermal adjustment	0,8 ÷ 1 I _n
Magnetic threshold (for 16 and 25A I _m = 400A)	10 x I _n

4.2 Switches technical characteristics

Switches	DPX ³ -I 160
Rated current I _n (A)	160
Rated insulation voltage U _i (V)	800
Rated operational voltage U _e (V)	690 V (ac) 500 V (dc)
Rated impulse withstand voltage U _{imp} (kV)	8
Ambient temperature (°C)	40
Endurance electrical / mechanical	8000/25000
Nominal frequency (Hz)	50-60
Rated short-time withstand current I _{sw} (1 s) (kA)	1,7
Rated short-circuit making capacity I _{cm} (kA)	2,4
AC 22, AC 23, DC 22, DC 23 (A)	160

4.3 Breaking capacity (kA)

Breaking capacity I _{cu} and I _{cs} in AC (KA)					
	U _e	16 kA	25 kA	36 kA	50 kA
I _{cu} (kA)	220/240V	25	36	50	65
	380/415V	16	25	36	50
	440V	10	18	25	30
	460V	10	18	25	30
	480/500V	8	10	12	15
690V	5	5	8	10	
I _{cs} (%I _{cu})	-	100	100	100	100
Rated short-circuit making capacity I _{cm} (KA)					
	U _e	16 kA	25 kA	36 kA	50 kA
I _{cm} (kA)	415 V	32	52.5	75.6	105

4.4 Derating temperature Ta (°C)

Influence of ambient temperature Ta(°C)												
I _n (A)	-25	-20	-10	-5	0	10	20	30	40	50	60	70
16	23	22	21	21	20	19	18	17	16	15	15	14
25	37	35	34	33	32	30	28	26	25	23	22	21
40	55	54	52	51	50	47	43	42	40	38	36	34
63	88	87	84	83	81	76	69	66	63	60	57	55
80	115	113	111	109	107	97	87	84	80	78	75	72
100	135	133	130	123	115	108	104	102	100	95	90	85
125	160	158	155	153	150	138	130	127	125	118	112	105
160	224	221	214	210	205	192	176	168	160	152	145	139

4.5 Power loss (W)

4.5.1 Breaker power loss (W)

Power loss DPX ³ 160 (W)								
I _n (A) ---->	16	25	40	63	80	100	125	160
Cage terminals	2,8	5,0	5,1	6,7	7,0	11,0	12,5	15,4
Lugs	2,8	5,0	5,1	6,7	7,0	11,0	12,5	15,4
External terminals	2,8	5,0	5,1	6,7	7,0	11,0	12,5	15,4
Spreaders	2,8	5,0	5,1	6,7	7,0	11,0	12,5	15,4
Rear terminals	2,8	5,0	5,1	6,7	7,0	11,0	12,5	15,4
Plugin version	2,9	5,1	5,4	7,5	8,3	13,0	15,6	20,5

4.5.2 Switches power loss (W)

Power loss DPX ³ -I 160 (W)	
I _n (A) ---->	160
Cage terminals	9,2
Lugs	9,2
External terminals	9,2
Spreaders	9,2
Rear terminals	9,2
Plugin version	14,3

4.6 Short-circuit breaking capacity in D.C. current

Short-circuit breaking capacity in D.C. current				
Breaking capacity I _{cu} (kA)				
	2 p. in ser.	2 p. in ser.	3 p. in ser.	3 p. in ser.
	110-125V	250V	400V	500V
160 16 kA	32	16	16	10
160 25 kA	50	25	25	20
160 36 kA	60	30	30	25
160 50 kA	80	40	40	35

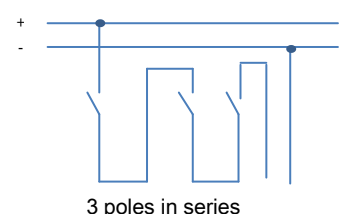
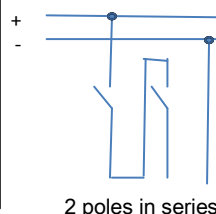

DPX³ 160

Thermal magnetic and trip-free switches

DPX³-I 160

Reference(s) : 420 000/ 001/ 002/003/ 004/ 005/ 006/ 007/ 010/ 011/ 012/ 013/ 014/ 015/ 016/ 017/ 040/ 041/ 042/ 043/ 044/ 045/ 046/ 047/ 050/ 051/ 052/ 053/ 054/ 055/ 056/ 057/ 080/ 081/ 082/ 083/ 084/ 085/ 086/ 087/ 090/ 091/ 092/ 093/ 094/ 095/ 096/ 097/ 120/ 121/ 122/ 123/ 124/ 125/ 126/ 127/ 130/ 131/ 132/ 133/ 134/ 135/ 136/ 137/ 198/ 199

4.7 Protection in DC

Protection in D.C. current		
	thermal	magnetic
160 16 kA	like AC	1,5 Im AC
160 25 kA	like AC	1,5 Im AC
160 36 kA	like AC	1,5 Im AC
160 50 kA	like AC	1,5 Im AC

4.8 Altitude

Altitude (m)				
	Altitude (m)	≤2000	3000	4000
DPX ³ 160	Rated current (A)	1 x In	0,96 x In	0,93 x In
	Rated voltage (V)	690	690	550
DPX ³ -I 160	Rated current (A)	1 x In	0,96 x In	0,93 x In
	Rated voltage (V)	500	500	400

4.9 Loads operation

Loads operation	
Rated current (A)	In=160
Opening (N)	45
Closing (N)	78
Reset (N)	75

5. CONFORMITY

IEC 60947-2
(for switches IEC 60947-3)
EN 60947-2
(for switches EN 60947-3)

6. MARKING

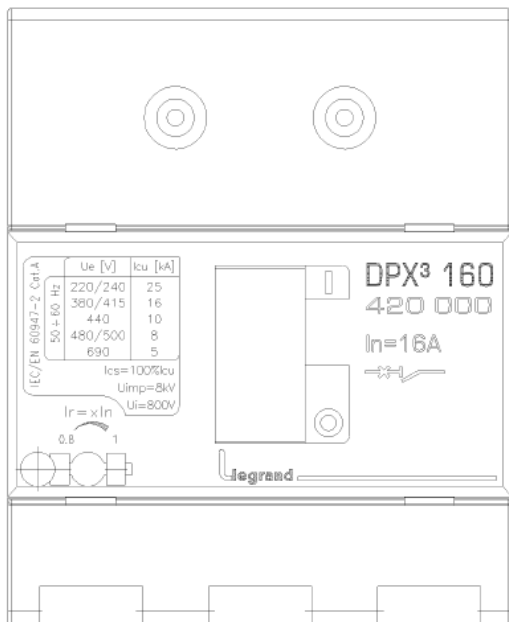

7. EQUIPMENTS AND ACCESSORIES

7.1 Releases

- Shunt releases with voltage:
 - 12 Vac/dc ref. 421 012
 - 24 Vac/dc ref. 421 013
 - 48 Vac/dc ref. 421 014
 - 110-130 Vac ref. 421 015
 - 200-277 Vac ref. 421 016
 - 380-480 Vac ref. 421 017
- undervoltage releases with voltage:
 - 12 Vac/dc ref. 421 018
 - 24 Vac/dc ref. 421 019
 - 48 Vac/dc ref. 421 020
 - 110 Vac ref. 421 021
 - 200-240 Vac ref. 421 022
 - 277 Vac ref. 421 023
 - 380-415 Vac ref. 421 024
 - 440-480 Vac ref. 421 025
- auxiliary contact:
 - set of connectors for aux contacts ref. 421 044
 - aux contacts and fault signal ref. 421 011
 - aux contacts (1NC and 1 NO) for all rotary handles ref. 421 010
 - inserted device signal ref. 421 048

7.2 Rotary handles :

- Direct:
- DPX³ direct rotary handle ref. 421 000
 - DPX³ emergency direct rotary handle ref. 421 002
- Vari-depth:
- DPX³ vari depth rotary handle ref. 421 004
 - DPX³ emergency vari depth rotary handle ref. 421 005

Locking accessories

- locking acc. for direct rotary handle - ronis ref. 421 006
- locking acc. for direct rotary handle - profalux ref. 421 007
- locking acc. for vari depth rotary handle - ronis ref. 421 008
- locking acc. for vari depth rotary handle - profalux ref. 421 009

7.3 Mechanical accessories :

Insulated shields

- Set of 3 ref. 421 070

Sealable terminal shields

- sealable terminal shield for rear terminals 160 3P ref. 421 050
- sealable terminal shield for rear terminals 160 4P ref. 421 051
- sealable terminal shield for front spreaders 160 3P ref. 421 054
- sealable terminal shield for front spreaders 160 4P ref. 421 055

Padlocks

- DPX³ padlock accessory for handle (off) ref. 421 049

Interlock:

- DPX³ interlock mounting plate ref. 421 058
- DPX³ interlock for plug-in / draw-out version ref. 421 059

7.4 Connection's accessories :

Cage terminals

- high capacity terminals for al or cu cables kit (3) - flex 1x120mm², rigid 1x150mm², bar/cable lug 18mm ref. 421 026
- high capacity terminals for al or cu cables kit (4) - flex 1x120mm², rigid 1x150mm², bar/cable lug 18mm ref. 421 027
- rack screw and nut for cable lug (3) ref. 421 028
- rack screw and nut for cable lug (4) ref. 421 029

Front spreaders

- DPX³ front spreaders for 3P DPX³ 160 (3) ref. 421 032
- DPX³ front spreaders for 4P DPX³ 160 (4) ref. 421 033

DPX³ 160

Thermal magnetic and trip-free switches

DPX³-I 160

Reference(s) : 420 000/ 001/ 002/003/ 004/ 005/ 006/ 007/ 010/ 011/
012/ 013/ 014/ 015/ 016/ 017/ 040/ 041/ 042/ 043/ 044/ 045/ 046/ 047/
050/ 051/ 052/ 053/ 054/ 055/ 056/ 057/ 080/ 081/ 082/ 083/ 084/ 085/
086/ 087/ 090/ 091/ 092/ 093/ 094/ 095/ 096/ 097/ 120/ 121/ 122/ 123/
124/ 125/ 126/ 127/ 130/ 131/ 132/ 133/ 134/ 135/ 136/ 137/ 198/ 199

Rear terminals

- DPX³ flat rear terminals for 3P DPX³ 160 (3) ref. 421 036
- DPX³ flat rear terminals for 4P DPX³ 160 (4) ref. 421 037

7.5 Plug-in version

Bases

- front/rear terminals plug-in base 3P DPX³ 160 ref. 421 040
- front/rear terminals plug-in base 4P DPX³ 160 ref. 421 041

Locking accessories

- locking accessory for plug-in base – ronis ref. 421 045
- locking accessory for plug-in base – profalux ref. 421 046
- padlock accessory for plug-in base ref. 421 047

7.6 Motor operator

- side motor operator 24-230 Vac - 24-230 Vdc ref. 421 060
- front motor operator 24-230 Vac - 24-230 Vdc ref. 421 061

Locking accessories for front motor operator:

- locking acc. for front motor operator - ronis ref. 421 062
- locking acc. for front motor operator – profalux ref. 421 063
- padlock selector for front motor operator ref. 421 064

Locking accessories for side motor operator:

- locking acc. for side motor operator - ronis ref. 421 065
- locking acc. for side motor operator – profalux ref. 421 066
- padlock selector for side motor operator ref. 421 067

Din plate:

- DPX³ din plate for motor operator DPX³ 160 ref. 421 068

7.7 Mounting on rail fixing plate

- DPX³ din rail fixing plate DPX³ 160 3P/4P ref. 421 071

DPX³ 160

Thermal magnetic and trip-free switches

DPX³-I 160

Reference(s) : 420 000/ 001/ 002/003/ 004/ 005/ 006/ 007/ 010/ 011/
012/ 013/ 014/ 015/ 016/ 017/ 040/ 041/ 042/ 043/ 044/ 045/ 046/ 047/
050/ 051/ 052/ 053/ 054/ 055/ 056/ 057/ 080/ 081/ 082/ 083/ 084/ 085/
086/ 087/ 090/ 091/ 092/ 093/ 094/ 095/ 096/ 097/ 120/ 121/ 122/ 123/
124/ 125/ 126/ 127/ 130/ 131/ 132/ 133/ 134/ 135/ 136/ 137/ 198/ 199

8. CURVES

8.1 TRIPPING CURVE

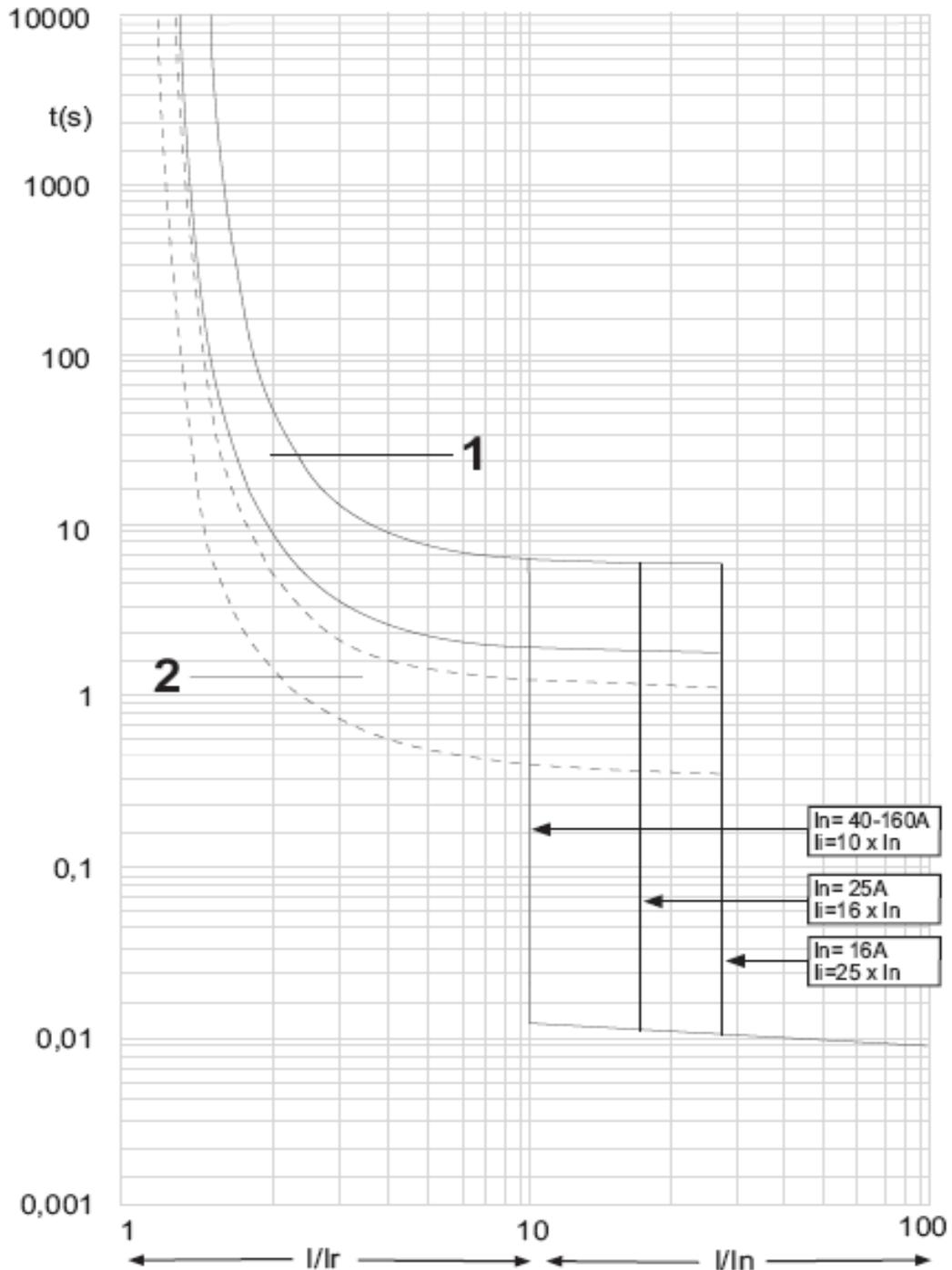

t = time
I = rated current □
Ir = setting current
curve number 1 = characteristic with cold start
curve number 2 = characteristic with hot start

DPX³ 160

Thermal magnetic and trip-free switches

DPX³-I 160

Reference(s) : 420 000/ 001/ 002/003/ 004/ 005/ 006/ 007/ 010/ 011/
012/ 013/ 014/ 015/ 016/ 017/ 040/ 041/ 042/ 043/ 044/ 045/ 046/ 047/
050/ 051/ 052/ 053/ 054/ 055/ 056/ 057/ 080/ 081/ 082/ 083/ 084/ 085/
086/ 087/ 090/ 091/ 092/ 093/ 094/ 095/ 096/ 097/ 120/ 121/ 122/ 123/
124/ 125/ 126/ 127/ 130/ 131/ 132/ 133/ 134/ 135/ 136/ 137/ 198/ 199

8.2 Energy curve

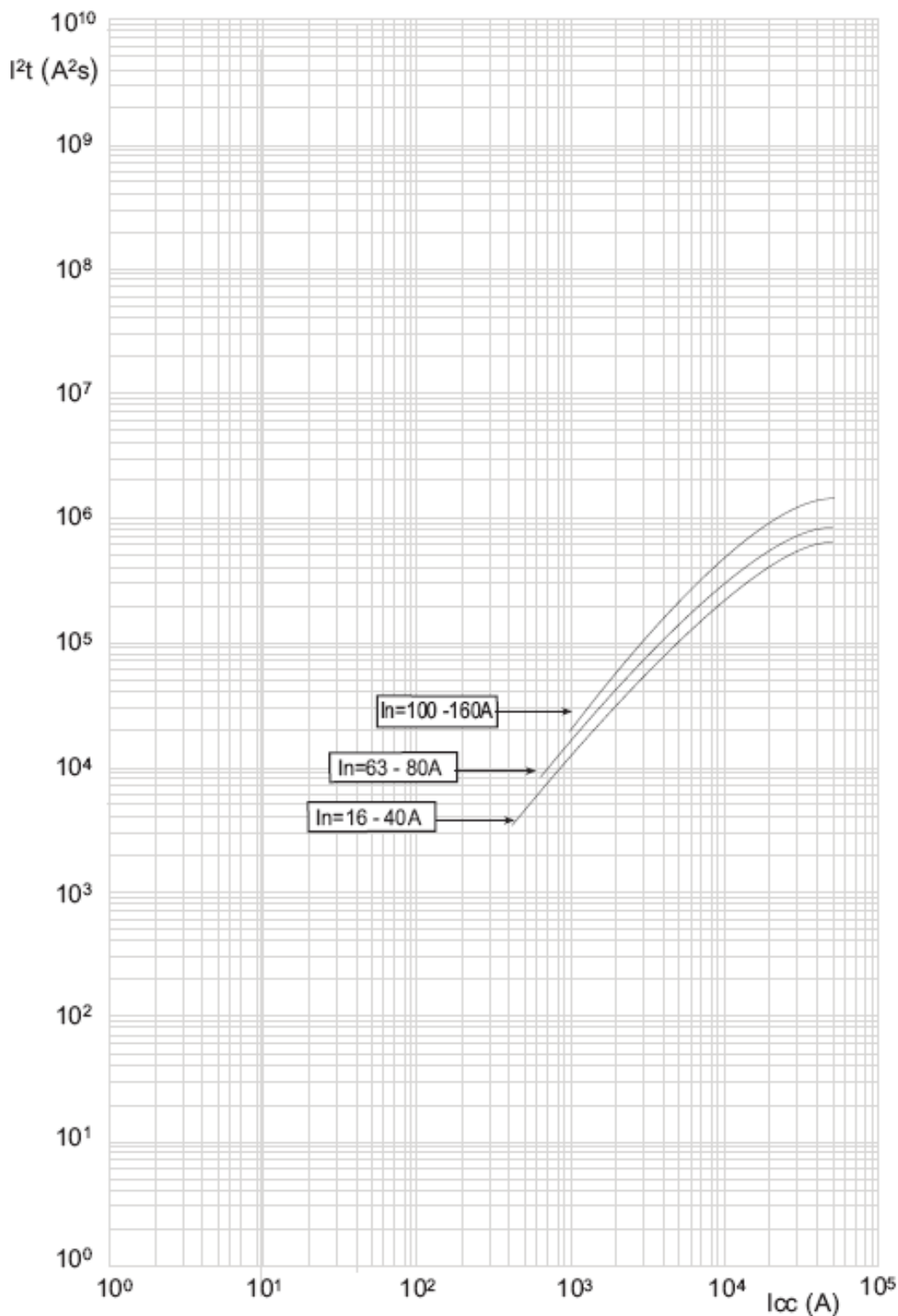

I_{cc} = estimated short circuit symmetrical current (RMS value)
 I^2t (A^2s) = pass-through specific energy

DPX³ 160

Thermal magnetic and trip-free switches

DPX³-I 160

Reference(s) : 420 000/ 001/ 002/003/ 004/ 005/ 006/ 007/ 010/ 011/ 012/ 013/ 014/ 015/ 016/ 017/ 040/ 041/ 042/ 043/ 044/ 045/ 046/ 047/ 050/ 051/ 052/ 053/ 054/ 055/ 056/ 057/ 080/ 081/ 082/ 083/ 084/ 085/ 086/ 087/ 090/ 091/ 092/ 093/ 094/ 095/ 096/ 097/ 120/ 121/ 122/ 123/ 124/ 125/ 126/ 127/ 130/ 131/ 132/ 133/ 134/ 135/ 136/ 137/ 198/ 199

8.3 Restricted current curve

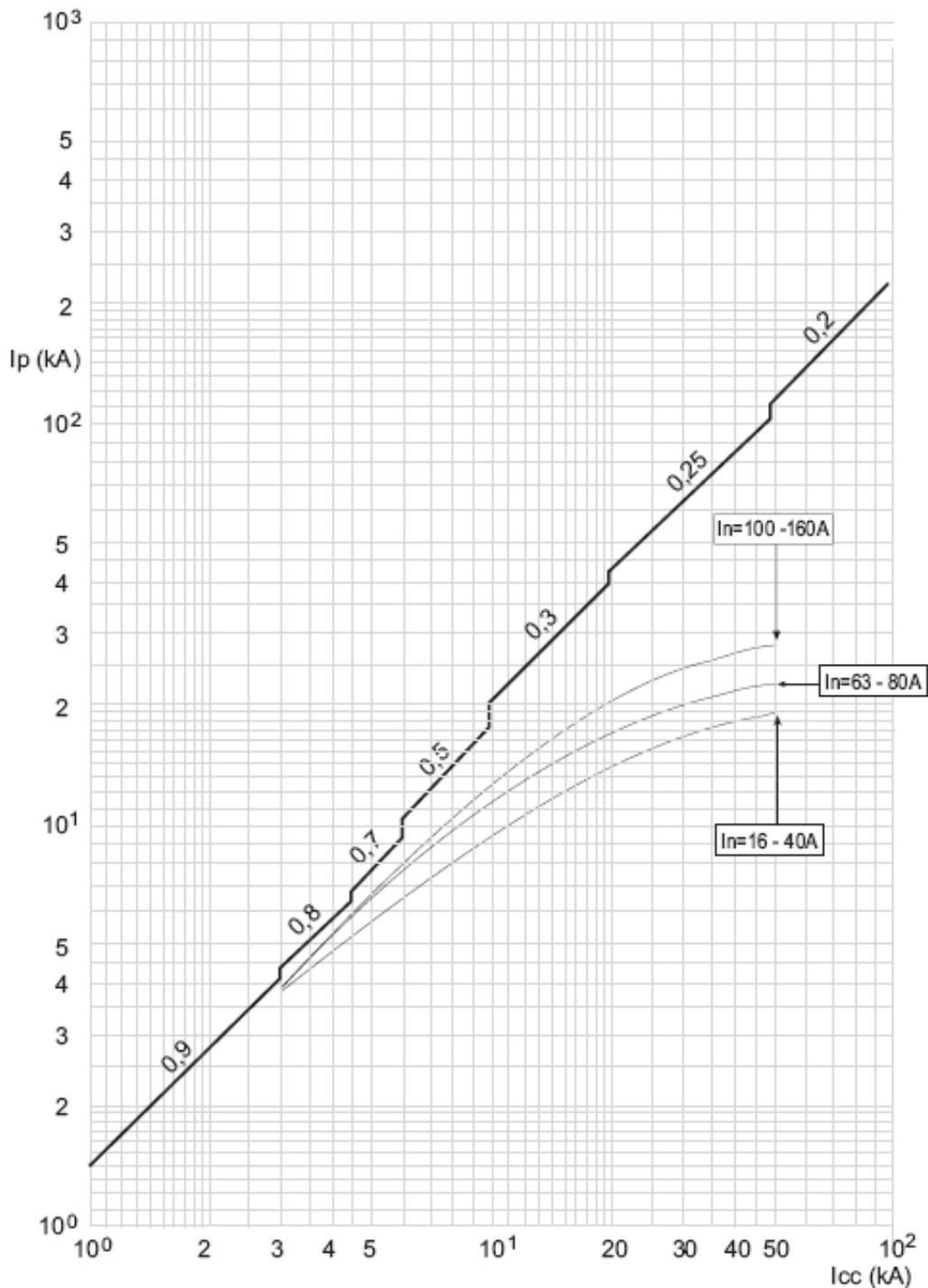

I_{cc} = estimated short circuit symmetrical current (RMS value)
 I_p = maximum short circuit peak current
 ——— maximum prospective short circuit peak current corresponding at the power factor
 - - - - - maximum real peak short circuit current