

Arteor™

hotel equipment – square version
data, audio and video sockets



Cover plates selection chart (p. 262-265)
Technical data (p. 244-248)

Pack	Cat.Nos		Data, audio and video sockets
	White	Magnesium	
20/200	5734 28	5736 28	RJ 45 tool-less system - Cat. 6 UTP - 8 contacts 1 module 22.5 x 45 mm
10/100	5734 74	5736 74	UTP - 8 contacts 2 modules 45 x 45 mm
1/20	5722 75	5727 75	USB sockets Used to bring connections closer to the user For connecting USB devices (scanner-printer, external hard disk) Connection via screw terminals cross-section 1 mm ² Recommended cable: USB A max. cable length 5 m 1 module 22.5 x 45 mm
1/20	5722 72	5727 72	2 x female RCA For the stereo audio connection of any DVD drive, camera, video recorder, etc. type peripheral Recommended cable: 1 shielded audio pair 1 module 22.5 x 45 mm
1/20	5722 73	5727 73	3 x female RCA For the composite video and stereo audio connection of a DVD drive, camera, video recorder, video conference equipment etc. Recommended cable: 1 shielded audio pair + 1 x 3 mm mini-coaxial 1 module 22.5 x 45 mm
1/20	5722 71	5727 71	YUV For analog high definition connection of a DVD, PC monitor, plasma screen, video projector, graphic paintbox, etc. Recommended cable: 3 x 3 mm mini-coaxial (max. cable length 25 m) or 3 x RG59 coaxial (max. cable length 50 m) 1 module 22.5 x 45 mm
1/20	5722 74	5727 74	Female 3.5 mm jack For stereo audio connection from a portable source Recommended cable: 1 x 0.22 mm ² shielded audio pair Connection on screw terminals 1 module 22.5 x 45 mm

Pack	Cat.Nos		Audio and video sockets (continued)
	White	Magnesium	
1/20	5722 82	5727 82	Female HD 15 For VGA, XGA or VESA connection of a PC monitor, plasma screen, video projector, graphic paintbox, etc. Recommended cable Cat.No 0327 81 Max. cable length 25 m (beyond this a VGA amplifier is recommended) Connection on screw terminals 2 modules 45 x 45 mm
1/20	5722 79	5727 79	Solder connection 1 module 22.5 x 45 mm
1/20	5722 81	5727 81	HDMI For digital high definition audio and video connection of a PC monitor, plasma screen, video projector, graphic paintbox, etc. Recommended cable Cat.No 0327 80 2 modules 45 x 45 mm
1/40	5744 01	5744 51	S-Video socket (4-pin mini-DIN) 1-gang Provides the YC video link for any peripheral device such as a DVD drive, camera, video recorder, videoconferencing, etc 1 module 22.5 x 45 mm
1/20	5722 88	5727 88	Female HD 15 + jack 3.5 mm 2 modules 45 x 45 mm Square version

Bold catalogue numbers are products normally available with Legrand (India) stockists.

Cat. nos. that are not bold - delivery within 4 - 8 weeks from the date of order.

Bold packing quantity is our mandatory packing. Orders to be placed by Legrand (India) stockists in multiples of the same.

Arteor™

10 Giga, Cat. 6 and Cat. 5e data sockets



Arteor™

rear pluggable data sockets and wiring splitter



Cover plates selection chart (p. 262-265)

Certified as conforming to standards ISO 11801 ed. 2.0, EN 50173-1 and EIA/TIA 568

Contacts marked with 568 A and B dual colour code and numbers

Connectors with self-stripping terminals

Possibility of re-wiring in the event of error

Multidirectionnal cable entry

Cover plates selection chart (p. 262-265)
Technical data (p. 257)

Certified as conforming to standards ISO 11801 ed. 2.0, EN 50173-1 and EIA/TIA 568

Contacts marked with 568 A and B dual colour code and numbers

Connectors with self-stripping terminals

Possibility of re-wiring in the event of error

Multidirectionnal cable entry

Pack	Cat.Nos		RJ 45 - tool-less system
	White	Magnesium	
10/100	5734 32	5728 06	<p>Rapid connection sockets, no tool required</p> <p>10 Giga</p> <p>Supports 10 G base-T applications up to 100 m in a channel conforming to ISO/IEC TIA TSB 155 and IEEE 802.3an</p> <p> STP/FTP - 9 contacts, shielded folded metal 1 module 22.5 x 45 mm</p> <p>Cat. 6</p> <p> STP - 9 contacts, shielded folded metal 2 modules 45 x 45 mm</p> <p>20/200 5734 34 5736 34 STP - 9 contacts 1 module 22.5 x 45 mm</p> <p>10/100 5734 76 5736 76 FTP - 9 contacts 2 modules 45 x 45 mm</p> <p>20/200 5734 28 5736 28 UTP - 8 contacts 1 module 22.5 x 45 mm</p> <p>10/100 5734 74 5736 74 UTP - 8 contacts 2 modules 45 x 45 mm</p> <p>Cat. 5e</p> <p>20/200 5734 30 5736 30 FTP - 9 contacts 1 module 22.5 x 45 mm</p> <p>20/200 5734 29 5736 29 UTP - 8 contacts 1 module 22.5 x 45 mm</p> <p>10/100 5734 75 5736 75 UTP - 8 contacts 2 modules 45 x 45 mm</p>

Pack	Cat.Nos		Rear pluggable RJ 45 sockets
	White	Magnesium	
10/100	5723 31	5728 31	<p>Used to create Cat. 6 and Cat. 5e links in accordance with standards 2 modules 45 x 45 mm</p> <p>Cat. 6</p> <p> UTP FTP</p> <p>Cat. 5e</p> <p> UTP FTP</p>
10/100	5723 33	5728 33	
10/100	5723 30	5728 30	
10/100	5723 32	5728 32	

Pack	Cat.Nos		Telephone/Ethernet wiring splitter
	White	Magnesium	
10/100	5723 36	5728 36	<p>Provide increased security against theft and damage to double connectors Provide a rate of 10/100 Mbps Multidirectionnal cable entry Can be installed in all supports min. depth 35 mm Telephone and Ethernet applications marked on the protective cap 1 module 22.5 x 45 mm</p> <p> FTP double connector 9 contacts</p> <p> UTP double connector 8 contacts</p>
10/100	5723 35	5728 35	

Bold catalogue numbers are products normally available with Legrand (India) stockists.

Cat. nos. that are not bold - delivery within 4 - 8 weeks from the date of order.

Bold packing quantity is our mandatory packing. Orders to be placed by Legrand (India) stockists in multiples of the same.

Arteor™
data, audio and video sockets

■ **Technical data**

2 x female RCA

Cat. no. 5722 72/5727 72 / 5732 72/5737 72

3 x female RCA

Cat. no. 5722 73 / 5727 73 / 5732 73 / 5737 73

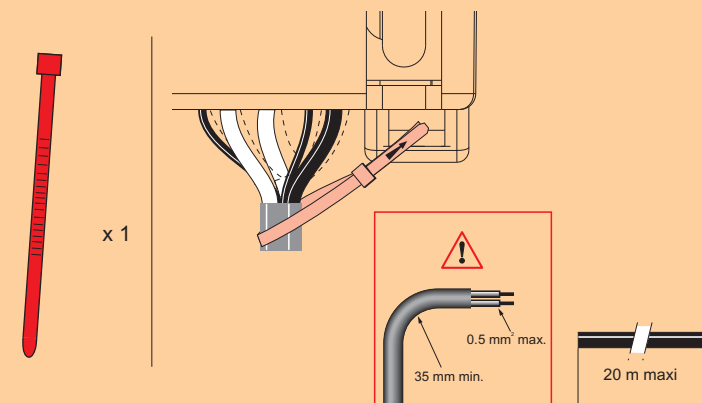
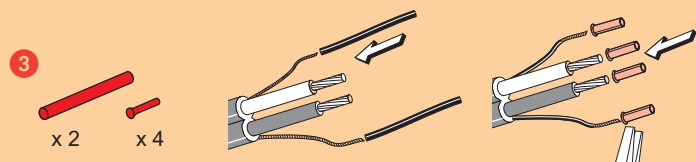
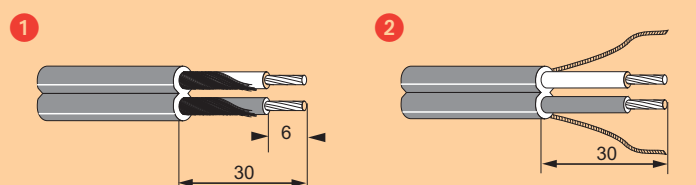
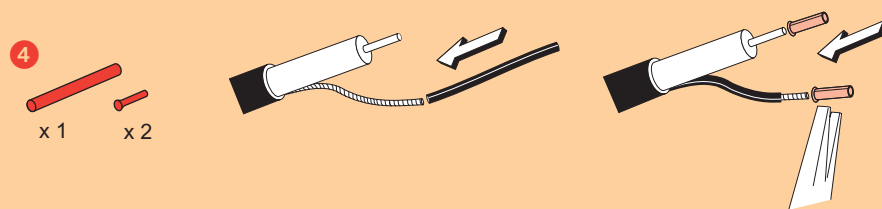
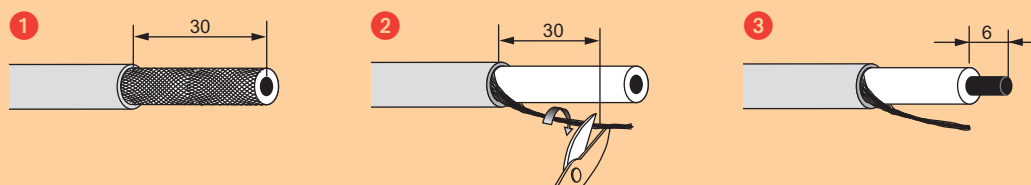
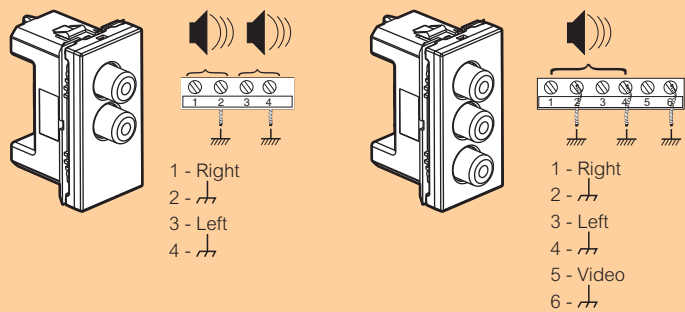

Arteor™

data, audio and video sockets

■ Technical data

Female 3.5 mm Jack

Cat. no. 5722 74 - 5727 74

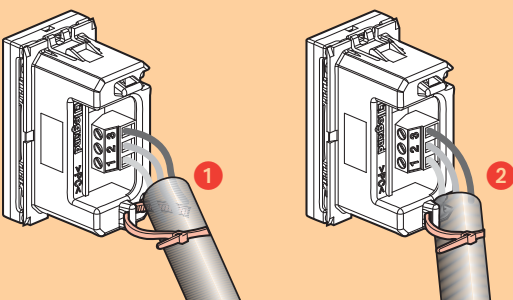
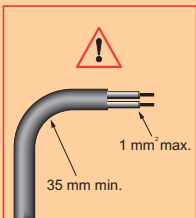
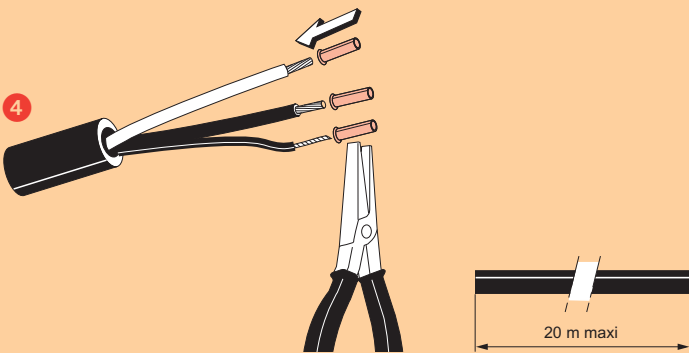
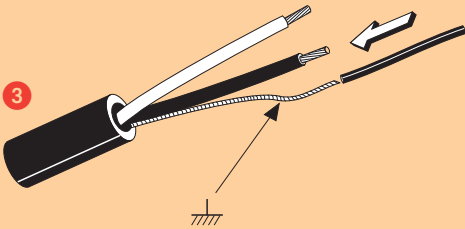
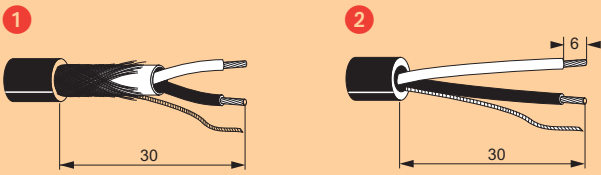
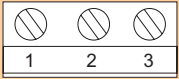

HD 15 socket

Cat. no. 5722 82 / 5727 82

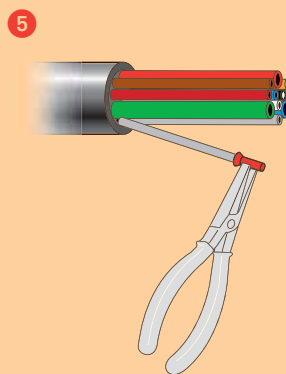
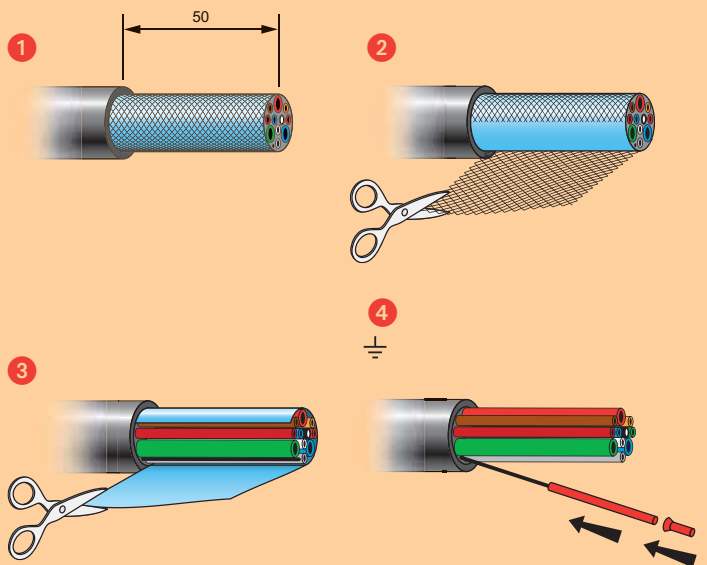
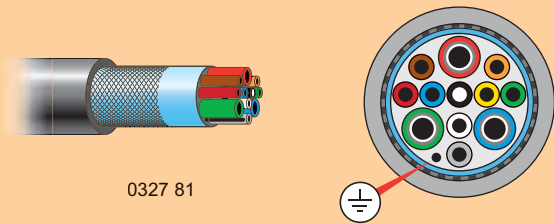
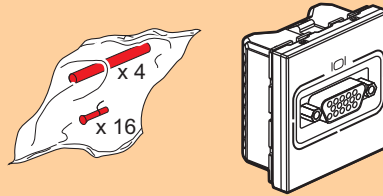

■ **Technical data**

HD 15 socket

Cat. no. 5722 82 / 5727 82

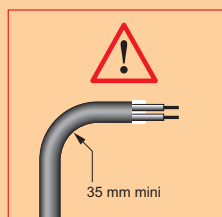
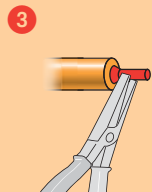
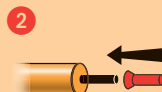
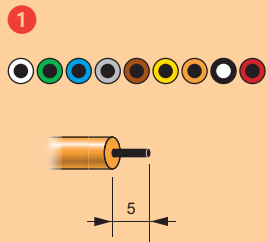
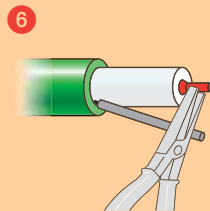
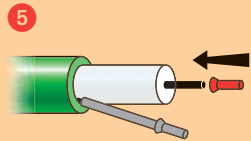
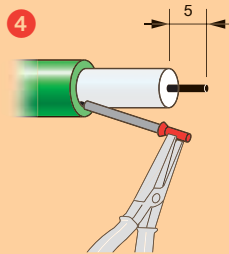
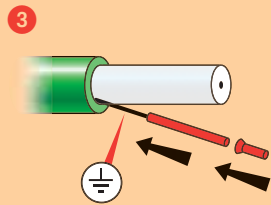
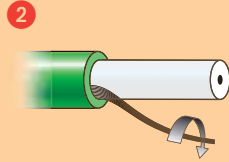
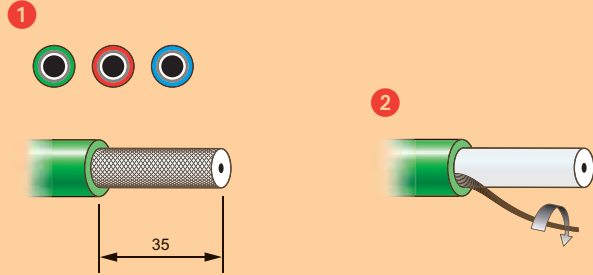

HD 15 socket

Cat. no. 5722 82 / 5727 82

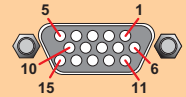
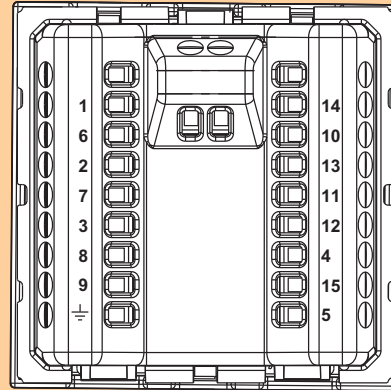

Terminal strip marking (Connector marking)

VGA FULL PIN

- { 1 Video rec (red)
- { 6 Red (general + ground)
- { 2 Video green (green)
- { 7 Green shield (green ground)
- { 3 Video blue (blue)
- { 8 Blue shield (blue ground)
- 9 White
- 14 Green (SV)
- 10 Blue (ground SH-SV)
- 13 Grey (SH)
- 11 Brown (ID Bit 0)
- 12 Yellow (ID Bit 1)
- 4 Orange (ID Bit 2)
- 15 Black (ID Bit 3)
- 5 Red (Gnd)

VGA R V B SH SV

- 1 Video rec (red)
- 2 Video green (green)
- 3 Video blue (blue)
- 13 Video white (SH)
- 14 Video yellow (SV)
- 6 Red + generale shield (generale + ground)
- 7 Green shield (green ground)
- 8 Blue shield (blue ground)
- 10 Yellow + white shield (masse SH-SV)

Arteor™

data, audio and video sockets

■ Technical data

HDMI socket

Cat. no. 5722 81 / 5727 81

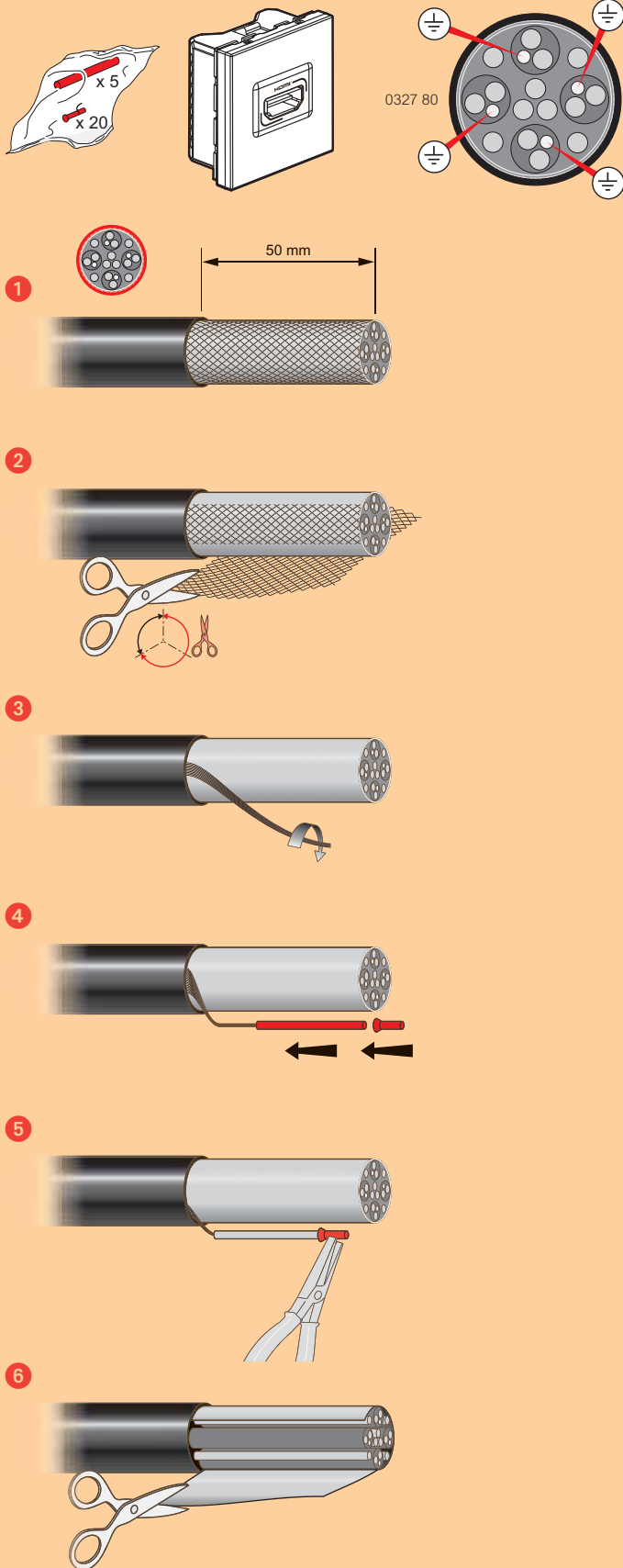

HDMI socket

Cat. no. 5722 81 / 5727 81

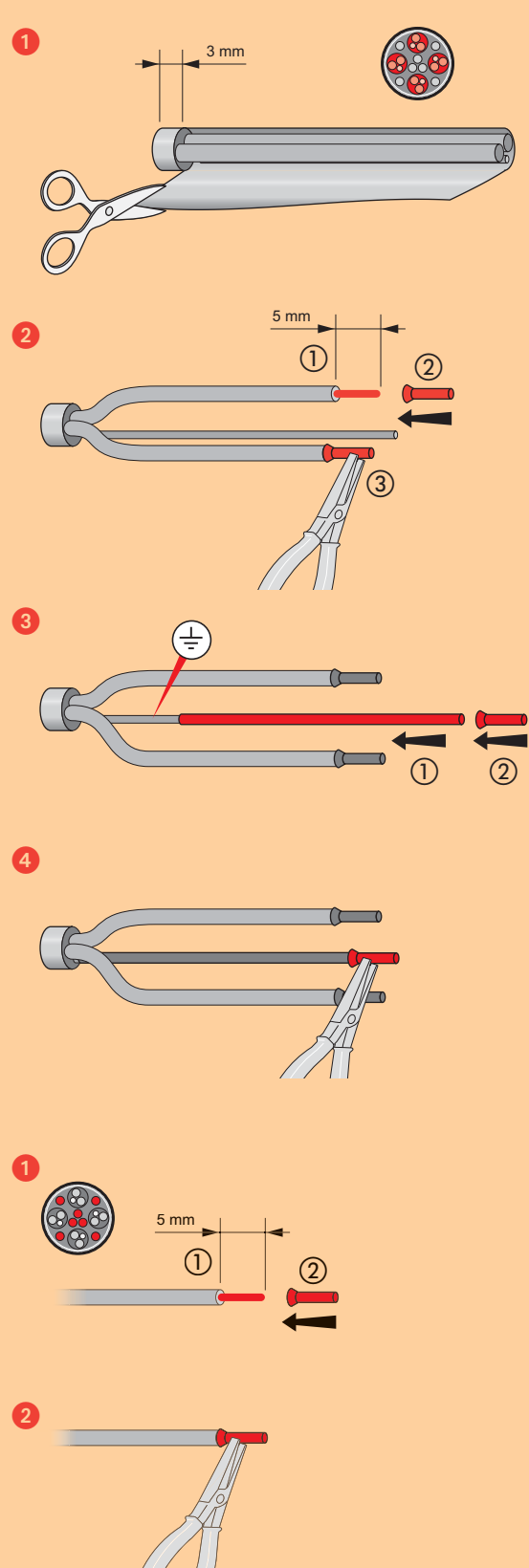

Arteor™
data, audio and video sockets

■ Technical data

HDMI socket (continued)

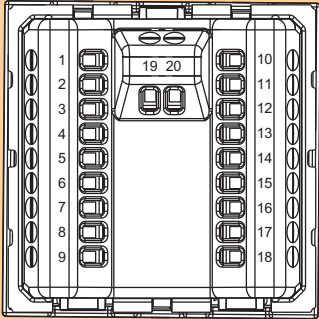

- 1 - TMDS Data 2+
- 2 - TMDS Data 2
- 3 - TMDS Data 2-
- 4 - TMDS Data 1+
- 5 - TMDS Data 1
- 6 - TMDS Data 1-
- 7 - TMDS Data 0+
- 8 - TMDS Data 0
- 9 - TMDS Data 0-
- 10 - TMDS Clock+
- 11 - TMDS Clock
- 12 - TMDS Clock-

- 13 - CEC
- 14 -
- 15 - SCL
- 16 - SDA
- 17 - Ground
- 18 - + 5v
- 19 - HPD
- 20 - general (grounding) strand

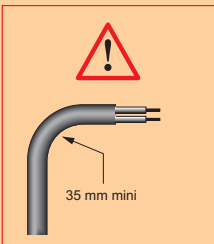

USB socket

Cat. no. 5722 75 / 5727 75 / 5732 74 / 5737 74

- | | | | | |
|---|---|---|---|---|
| 1 | 2 | 3 | 4 | 5 |
|---|---|---|---|---|
- 1 - Vbus (5V)
 - 2 - D-
 - 3 - D+
 - 4 -
 - 5 -

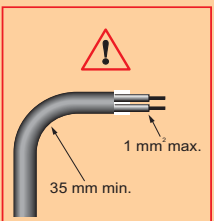
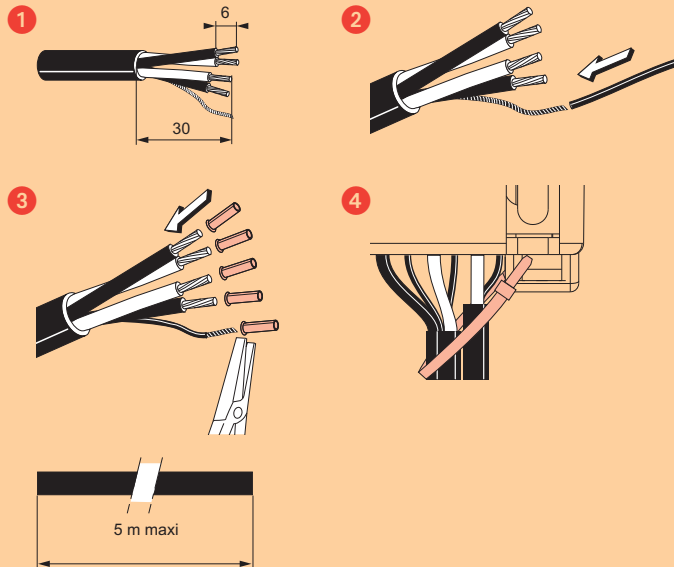

USB socket

Cat. no. 5722 75 / 5727 75 / 5732 74 / 5737 74

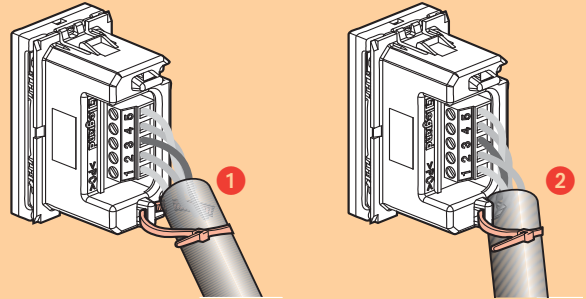

YUV socket

Cat. no. 5722 71 / 5727 71

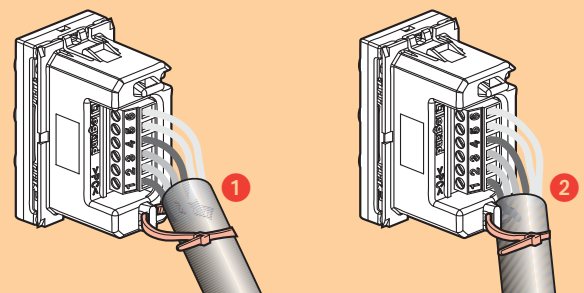
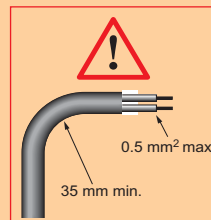
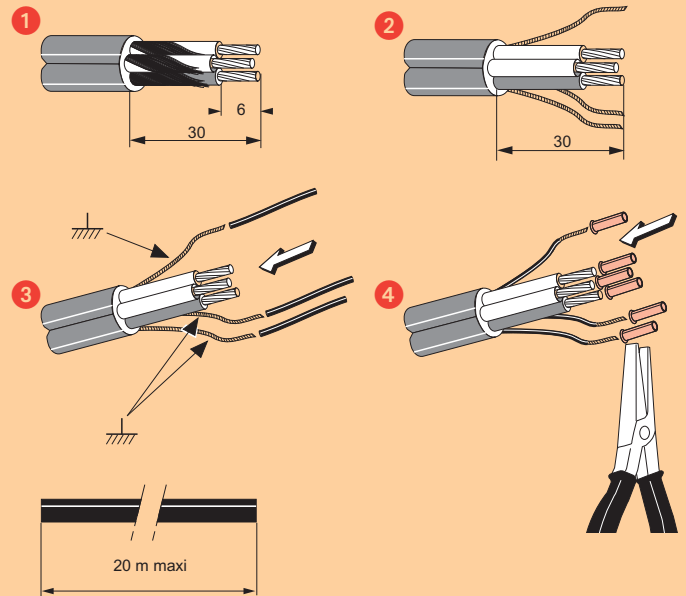
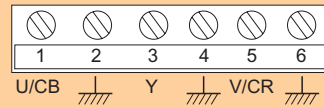

Arteor™

cover plates - square version

Modules	Plates + Support frames	COVER PLATES						
		Neutral		Tattoo	Mirror			
		White	Pearl alu	Graphite	Edition 1	Mirror white	Mirror black	
INDIAN STANDARD								
1 module		5757 00	5757 01	5757 02	5762 98	5757 04	5757 03	
2 modules		5757 10	5757 11	5757 12	5763 18	5757 14	5757 13	
3 modules		5757 20	5757 21	5757 22	5763 38	5757 24	5757 23	
3 modules for shaver sockets ⁽¹⁾		5750 70	5750 71	5750 72	5761 68	5750 74	5750 73	
4 modules		5757 30	5757 31	5757 32	5763 58	5757 34	5757 33	
6 modules		5757 40	5757 41	5757 42	5763 88	5757 44	5757 43	
8 modules		5757 50	5757 51	5757 52	5764 08	5757 54	5757 53	
2 x 4 modules		5757 60	5757 61	5757 62	-	5757 64	5757 63	
2 x 6 modules		5757 70	5757 71	5757 72	-	5757 74	5757 73	
2 x 8 modules		5757 80	5757 81	5757 82	-	-	-	
3 x 6 modules		5757 90	5757 91	5757 92	-	-	-	
3 x 8 modules		5758 00	5758 01	5758 02	-	-	-	
SPECIAL PLATES								
Video internal display unit 2.5", BUS alarm module 3.5" touch screen ⁽¹⁾		-	-	-	-	5764 94	5764 93	
10" multimedia touch screen ⁽¹⁾		-	-	-	-	5765 04	5765 03	
Central unit for: - temperature control - intruder alarm ⁽¹⁾		-	-	-	-	5765 34	5765 33	

(1) Support frame supplied with mechanism

COVER PLATES

Mirror		Graphic		Brushed metal		Wood		Leather		Signature
Mirror red	Mirror taupe	Casual	Formal	Stainless steel	Gold brass	Wenge style	Light Oak	Club	Galuchat	Woven metal
5762 96	5762 95	5762 91	5762 92	5757 06	5762 90	5757 05	5762 99	5762 93	5762 94	5762 97
5763 16	5763 15	5763 11	5763 12	5757 16	5763 10	5757 15	5763 19	5763 13	5763 14	5763 17
5763 36	5763 35	5763 31	5763 32	5757 26	5763 30	5757 25	5763 39	5763 33	5763 34	5763 37
5761 66	5761 65	5761 61	5761 62	5750 76	5761 60	5750 75	5761 69	5761 63	5761 64	5761 67
5763 56	5763 55	5763 51	5763 52	5757 36	5763 50	5757 35	5763 59	5763 53	5763 54	5763 57
5763 86	5763 85	5763 81	5763 82	5757 46	5763 80	5765 75	5763 89	5763 83	5763 84	5763 87
5764 06	5764 05	5764 01	5764 02	5757 56	5764 00	5765 95	5764 09	5764 03	5764 04	5764 07
-	-	-	-	5757 66	-	-	-	-	-	-
-	-	-	-	5757 76	-	-	-	-	-	-
-	-	-	-	-	-	-	-	-	-	-
-	-	-	-	-	-	-	-	-	-	-
-	-	-	-	-	-	-	-	-	-	-
-	-	-	-	5764 96	5764 90	-	-	-	-	5764 97
-	-	-	-	5765 06	5765 00	-	-	-	-	5765 07
-	-	-	-	5765 36	5765 30	-	-	-	-	5765 27

Arteor™

cover plates - round version

Modules	Plates + Support frames	COVER PLATES					
		Neutral			Tattoo	Mirror	
		White	Pearl alu	Graphite	Edition 1	Mirror white	Mirror black
INDIAN STANDARD							
2 modules		5759 00	5759 01	5759 02	5763 08	5759 04	5759 03
3 modules		5759 10	5759 11	5759 12	5763 28	5759 14	5759 13
4 modules		5759 20	5759 21	5759 22	5763 48	5759 24	5759 23
6 modules		5759 30	5759 31	5759 32	5763 68	5759 34	5759 33
8 modules		5765 80	5765 81	5765 82	5763 98	5765 84	5765 83
2 x 4 modules		5759 40	5759 41	5759 42	-	5759 44	5759 43
2 x 6 modules		5759 50	5759 51	5759 52	-	5759 54	5759 53

COVER PLATES

Mirror		Graphic		Brushed metal		Wood		Leather		Signature
Mirror red	Mirror taupe	Casual	Formal	Stainless steel	Gold brass	Wenge style	Light Oak	Club	Galuchat	Woven metal
5763 06	5763 05	5763 01	5763 02	5759 06	5763 00	5759 05	5763 09	5763 03	5763 04	5763 07
5763 26	5763 25	5763 21	5763 22	5759 16	5763 20	5759 15	5763 29	5763 23	5763 24	5763 27
5763 46	5763 45	5763 41	5763 42	5759 26	5763 40	5759 25	5763 49	5763 43	5763 44	5763 47
5763 66	5763 65	5763 61	5763 62	5759 36	5763 60	5759 35	5763 69	5763 63	5763 64	5763 67
5763 96	5763 95	5763 91	5763 92	5765 86	5763 90	5765 85	5763 99	5763 93	5763 94	5763 97
-	-	-	-	5759 46	-	-	-	-	-	-
-	-	-	-	5759 56	-	-	-	-	-	-