

Arteor™

hotel equipment - square and round version and call indicators

Arteor™

hotel equipment - call confirmation, buzzers and chimes



5734 61



5725 67



5725 74



5736 43



Cover plates selection chart p. 108-111
Technical data p. 81-99

Pack	Cat.Nos		Hotel bedroom call indicators
			Enables the resident to inform hotel staff of the room status Two settings are possible: - Do not disturb - Please clean the room 1 + 1 modules 22.5 x 45 mm
5/50	White 5734 61	Magnesium 5736 61	Indicator Indicator lamp and bell push Installed in the corridor, display calls Supplied with LED Square version
5/40	5720 67	5725 67	Round version
10/100	5734 58	5736 58	Internal control unit Allows the user to select the desired setting Supplied with LED Square version
5/50	5720 74	5725 74	Round version



Cover plates selection chart p. 108-111

Pack	Cat.Nos		Bell push call indicator and register
20/200			White 5734 15 Magnesium 5736 15 230 V 1 module 22.5 x 45 mm
5/50	5736 06		Accessories Set of labels
20/200			White 5734 42 Magnesium 5736 42 230 V 1 module 22.5 x 45 mm
10/100			White 5734 43 Magnesium 5736 43 Electronic chime 230/240 V AC - 50 Hz 2 modules 45 x 45 mm Tone level: 70 dB at 1 m Can be controlled by push-buttons Can be associated to movement detectors Cat.Nos 5720 53, 5740 61

Technical data

Biometric reader

Stand-alone

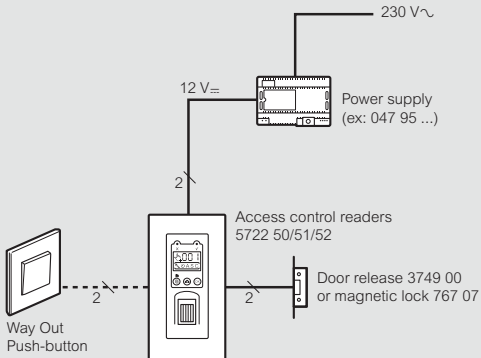

Centralized

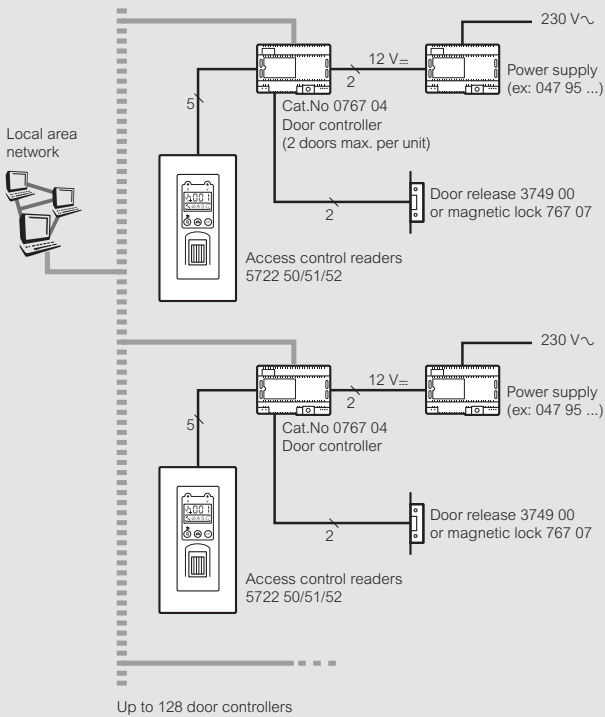

Key fob switches

Cat.Nos 5722 30/5727 30

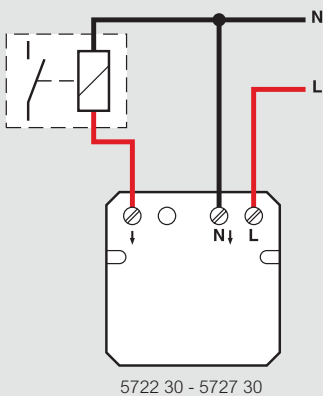

Technical data

Cat.Nos 5720 67/74 - 5725 67/74, 5734 58/61 - 5736 58/61

Description

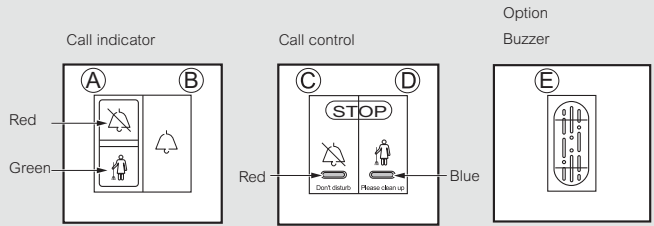

Wiring

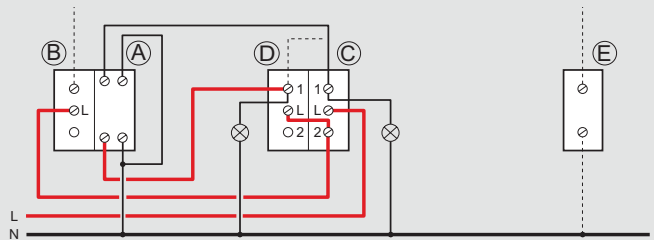

Operation

1- Instruction : «Do not disturb»

Bedroom

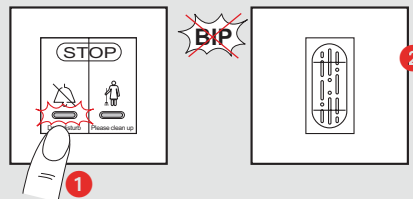

Corridor



2- Instruction : «Please clean up»

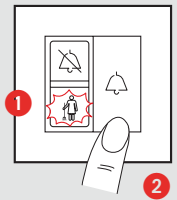
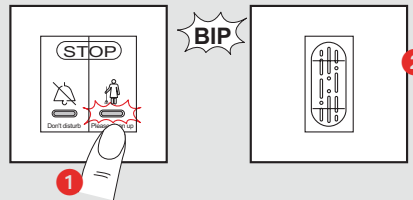

3- No call

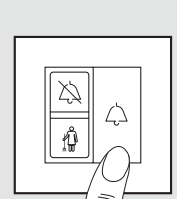
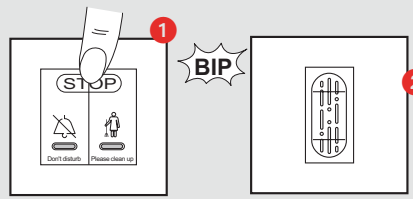

Note : If both buttons are pressed simultaneously, priority is given to the «don't disturb» call

