

**NEW**

# Raceways and junction boxes for screed floors

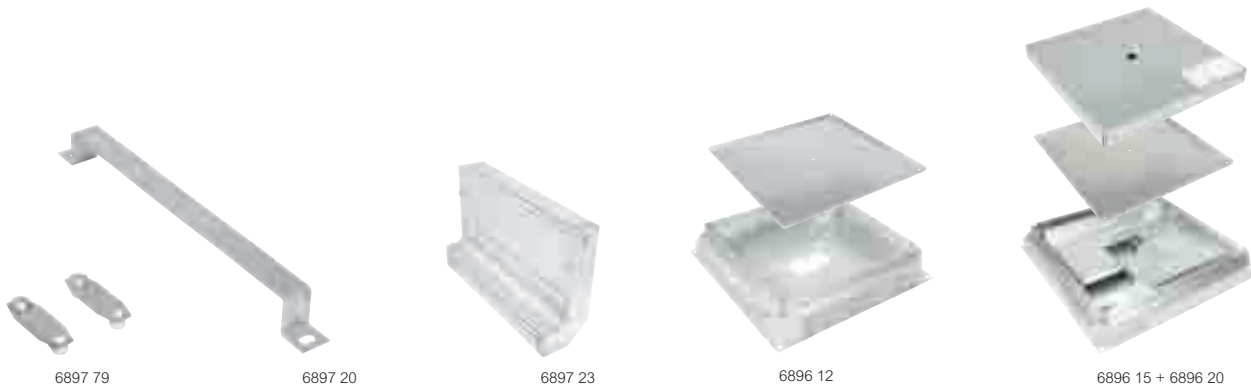

*Dimensions (p. 428-429)*  
*Technical characteristics (p. 428-429)*

Confirms to EN 50 085 - 2 - 2.  
Raceways are made from PVC and Galvanised sheet.  
Compatible with Cat.6 structured cabling system.

Pack	Cat.Nos	<b>Raceways accessories</b>
		<b>Fixing bracket</b>
		For fixing Raceways on the floor
9	<b>6897 09</b>	50 mm x 25 mm (metal)
9	<b>6897 10</b>	75 mm x 25 mm (PVC and metal)
9	<b>6897 12</b>	100 mm x 25 mm (metal)
9	<b>6897 15</b>	150 mm x 25 mm (PVC and metal)
9	<b>6897 20</b>	225 mm x 25 mm (PVC and metal)
9	<b>6897 30</b>	300 mm x 25 mm (PVC and metal)
9	<b>6897 27</b>	50 mm x 38 mm (PVC and metal)
9	<b>6897 28</b>	75 mm x 38 mm (metal)
9	<b>6897 37</b>	100 mm x 38 mm (PVC and metal)
9	<b>6897 38</b>	150 mm x 38 mm (PVC and metal)
9	<b>6897 25</b>	225 mm x 38 mm (metal)
9	<b>6897 35</b>	300 mm x 38 mm (metal)
		<b>Riser</b>
1	<b>6897 23</b>	Vertical - 225 mm width Raceways
1	<b>6897 33</b>	Vertical - for 300 mm width Raceways
		<b>Coupler for joining Raceways</b>
6	<b>6897 77</b>	Coupling 38
6	<b>6897 79</b>	Coupling 25

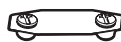
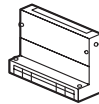
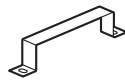

Pack	Cat.Nos	<b>Junction box</b>
		For direct access to cables at the intersection of Raceways
		Supplied completely with base and cover plate (Lid)
		<b>Height adjustable junction box 65 - 90 mm</b>
1	<b>6896 10</b>	150 x 150 x 65 - 90 mm
1	<b>6896 11</b>	225 x 225 x 65 - 90 mm
1	<b>6896 12</b>	300 x 300 x 65 - 90 mm
1	<b>6896 13</b>	400 x 400 x 65 - 90 mm
		<b>Height adjustable junction box 65 - 90 mm with fly over</b>
		For direct access to cables at the intersection of floor Raceways while maintaining perfect separation and 90° cross overs between data and power cables
1	<b>6896 14</b>	225 x 225 x 65 - 90 mm with flyover
1	<b>6896 15</b>	300 x 300 x 65 - 90 mm with flyover
1	<b>6896 16</b>	400 x 400 x 65 - 90 mm with flyover
		<b>Optional site cover for junction box</b>
10	<b>6896 18</b>	150 x 150 x 65 - 90 mm with metal cover
10	<b>6896 19</b>	225 x 225 x 65 - 90 mm with metal cover
10	<b>6896 20</b>	300 x 300 x 65 - 90 mm with metal cover
10	<b>6896 21</b>	400 x 400 x 65 - 90 mm with metal cover



## Raceways accessories for screed floor

### ■ Dimensions

#### Riser Cat.Nos 6897 23/33

The riser allows a change of direction (horizontal to vertical) of the Raceways. Conduit or Raceways can be run vertically from the box.

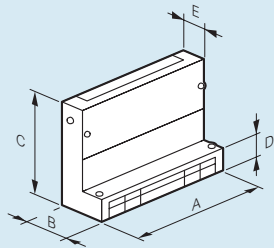

Use for Raceways	Cat.Nos
225 x 38 mm PVC or metal	6897 23
300 x 25 / 38 mm PVC or metal	6897 33

Cat.Nos	A (mm)	B (mm)	C (mm)	D (mm)	E (mm)
6897 23	250	89	201	43	52
6897 33	325	89	201	43	52

### ■ Dimensions

#### Fixing bracket Cat.Nos 6897 09/10/12/15/20/25/27/28/30/35/37/38

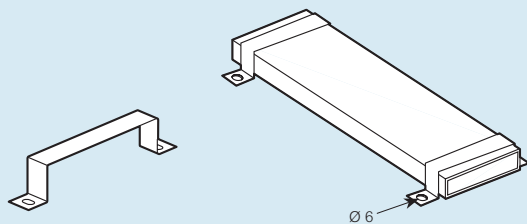

For fixing Raceways onto the slab.

Dimension (mm)

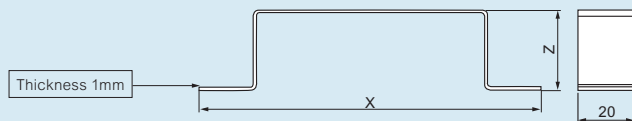

Dimension (mm)

Cat.Nos	Fixing brackets	X	Z
6897 09	50 x 25 mm	92	27.5
6897 10	75 x 25 mm	120	27.5
6897 12	100 x 25 mm	142	27.5
6897 15	150 x 25 mm	194	27.5
6897 20	225 x 25 mm	267	27.5
6897 30	300 x 25 mm	342	27.5
6897 27	50 x 38 mm	92	40.5
6897 28	75 x 38 mm	120	40.5
6897 37	100 x 38 mm	142	40.5
6897 38	150 x 38 mm	194	40.5
6897 25	225 x 38 mm	267	40.5
6897 35	300 x 38 mm	342	40.5

#### Couplings Cat.Nos 6897 77/79

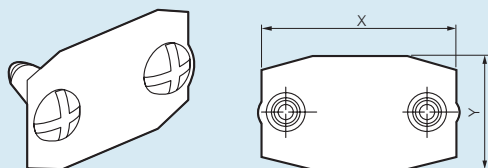

Used to connect two Raceways lengths

Cat.Nos	Designation	X	Z
6897 77	Coupling 38	55	32
6897 79	Coupling 25	55	19

Thickness: 1mm, Comes with 2 screws M6 x 10

## junction box for screed floor

### ■ Dimensions

#### Junction box Cat.Nos 6896 10/11/12/13/14/15/16

The junction box should be positioned directly on the slab. It provides access to cables at the intersection of trunkings or changes of direction. The junction box allows deviation of power and data cables. Screed height should be between 65 to 90 mm. Junction boxes are supplied with a base with flyovers and a lid. A disposable cover protection is available as an option. Side plates are pierced to suit Raceways.

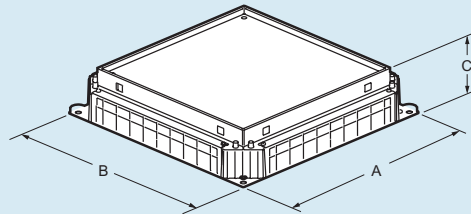

Dimensions (mm)

Cat.Nos	A	B	C
6896 10	252	252	65-90
6896 11/14	325	325	65-90
6896 12/15	402	402	65-90
6896 13/16	500	500	65-90

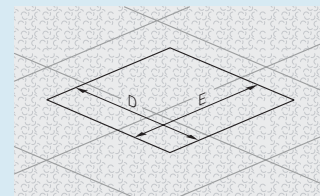
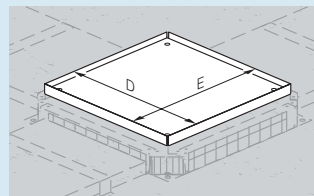

Dimensions (mm) for carpet cut out

Cat.Nos	D	E
6896 10	192.5	192.5
6896 11/14	263	263
6896 12/15	340	340
6896 13/16	437	437

Note: junction box with flyovers include for Cat.Nos 6896 14/15/16

