

Circuit breaker size S00 for starter combination Rated current 0.32 A  
N-release 4.2 A screw terminal Standard switching capacity



Product brand name	SIRIUS
Product designation	Circuit breaker
Design of the product	For starter combinations
Product type designation	3RV2

General technical data	
Size of the circuit-breaker	S00
Size of contactor can be combined company-specific	S00, S0
Product extension	
• Auxiliary switch	Yes
Power loss [W] total typical	5 W
Insulation voltage with degree of pollution 3 rated value	690 V
Surge voltage resistance rated value	6 kV
maximum permissible voltage for safe isolation	
• in networks with grounded star point between main and auxiliary circuit	400 V
• in networks with grounded star point between main and auxiliary circuit	400 V
Protection class IP	

<ul style="list-style-type: none"> <li>• on the front</li> <li>• of the terminal</li> </ul>	IP20 IP20
<b>Shock resistance</b>	
<ul style="list-style-type: none"> <li>• acc. to IEC 60068-2-27</li> </ul>	25g / 11 ms
<b>Mechanical service life (switching cycles)</b>	
<ul style="list-style-type: none"> <li>• of the main contacts typical</li> <li>• of auxiliary contacts typical</li> </ul>	100 000 100 000
<b>Electrical endurance (switching cycles)</b>	
<ul style="list-style-type: none"> <li>• typical</li> </ul>	100 000
Certificate of suitability ATEX	No
<b>Protection against electrical shock</b>	finger-safe
<b>Reference code acc. to DIN EN 81346-2</b>	Q

#### Ambient conditions

<b>Installation altitude at height above sea level</b>	
<ul style="list-style-type: none"> <li>• maximum</li> </ul>	2 000 m
<b>Ambient temperature</b>	
<ul style="list-style-type: none"> <li>• during operation</li> <li>• during storage</li> <li>• during transport</li> </ul>	-20 ... +60 °C -50 ... +80 °C -50 ... +80 °C
Relative humidity during operation	10 ... 95 %

#### Main circuit

<b>Number of poles for main current circuit</b>	3
<b>Operating voltage</b>	
<ul style="list-style-type: none"> <li>• rated value</li> <li>• at AC-3 rated value maximum</li> </ul>	690 V 690 V
<b>Operating frequency rated value</b>	50 ... 60 Hz
<b>Operating current rated value</b>	0.32 A
<b>Operating current</b>	
<ul style="list-style-type: none"> <li>• at AC-3 <ul style="list-style-type: none"> <li>— at 400 V rated value</li> </ul> </li> </ul>	0.32 A
<b>Operating power</b>	
<ul style="list-style-type: none"> <li>• at AC-3 <ul style="list-style-type: none"> <li>— at 230 V rated value</li> <li>— at 400 V rated value</li> <li>— at 500 V rated value</li> <li>— at 690 V rated value</li> </ul> </li> </ul>	40 W 90 W 120 W 120 W
<b>Operating frequency</b>	
<ul style="list-style-type: none"> <li>• at AC-3 maximum</li> </ul>	15 1/h

#### Auxiliary circuit

<b>Number of NC contacts for auxiliary contacts</b>	0
<b>Number of NO contacts for auxiliary contacts</b>	0

<b>Number of CO contacts</b>	
• for auxiliary contacts	0
<b>Protective and monitoring functions</b>	
<b>Product function</b>	
• Ground fault detection	No
• Phase failure detection	No
<b>Operational short-circuit current breaking capacity (Ics) at AC</b>	
• at 240 V rated value	100 kA
• at 400 V rated value	100 kA
• at 500 V rated value	100 kA
• at 690 V rated value	100 kA
<b>Maximum short-circuit current breaking capacity (Icu)</b>	
• at AC at 240 V rated value	100 kA
• at AC at 400 V rated value	100 kA
• at AC at 500 V rated value	100 kA
• at AC at 690 V rated value	100 kA
<b>Breaking capacity short-circuit current (Icn)</b>	
• at 1 current path at DC at 150 V rated value	10 kA
• with 2 current paths in series at DC at 300 V rated value	10 kA
• with 3 current paths in series at DC at 450 V rated value	10 kA
<b>Response value current</b>	
• of instantaneous short-circuit trip unit	4.2 A
<b>UL/CSA ratings</b>	
<b>Full-load current (FLA) for three-phase AC motor</b>	
• at 480 V rated value	0.32 A
• at 600 V rated value	0.32 A
<b>Short-circuit protection</b>	
<b>Product function Short circuit protection</b>	Yes
<b>Design of the short-circuit trip</b>	magnetic
<b>Installation/ mounting/ dimensions</b>	
<b>Mounting position</b>	any
<b>Mounting type</b>	screw and snap-on mounting onto 35 mm standard mounting rail according to DIN EN 60715
<b>Height</b>	97 mm
<b>Width</b>	45 mm
<b>Depth</b>	97 mm
<b>Required spacing</b>	
• with side-by-side mounting	

— forwards	0 mm
— Backwards	0 mm
— upwards	50 mm
— downwards	50 mm
— at the side	0 mm
• for grounded parts	
— forwards	0 mm
— Backwards	0 mm
— upwards	50 mm
— at the side	30 mm
— downwards	50 mm
• for live parts	
— forwards	0 mm
— Backwards	0 mm
— upwards	50 mm
— downwards	50 mm
— at the side	30 mm

## Connections/Terminals







<b>Product function</b>	
• removable terminal for auxiliary and control circuit	No
<b>Type of electrical connection</b>	
• for main current circuit	screw-type terminals
<b>Arrangement of electrical connectors for main current circuit</b>	Top and bottom
<b>Type of connectable conductor cross-sections</b>	
• for main contacts	
— single or multi-stranded	2x (0,75 ... 2,5 mm <sup>2</sup> ), 2x 4 mm <sup>2</sup>
— finely stranded with core end processing	2x (0.5 ... 1.5 mm <sup>2</sup> ), 2x (0.75 ... 2.5 mm <sup>2</sup> )
• at AWG conductors for main contacts	2x (18 ... 14), 2x 12
<b>Tightening torque</b>	
• for main contacts with screw-type terminals	0.8 ... 1.2 N·m
<b>Design of screwdriver shaft</b>	Diameter 5 to 6 mm
<b>Size of the screwdriver tip</b>	Pozidriv 2
<b>Design of the thread of the connection screw</b>	
• for main contacts	M3



## Safety related data





<b>B10 value</b>	
• with high demand rate acc. to SN 31920	5 000
<b>Proportion of dangerous failures</b>	
• with low demand rate acc. to SN 31920	50 %

<ul style="list-style-type: none"> <li>with high demand rate acc. to SN 31920</li> </ul>	50 %
<b>Failure rate [FIT]</b>	
<ul style="list-style-type: none"> <li>with low demand rate acc. to SN 31920</li> </ul>	50 FIT
<b>T1 value for proof test interval or service life acc. to IEC 61508</b>	10 y
<b>Display version</b>	
<ul style="list-style-type: none"> <li>for switching status</li> </ul>	Handle

### Certificates/approvals

<b>General Product Approval</b>	<b>Declaration of Conformity</b>
 CCC	 CSA
 UL	 EAC
 KC	 EG-Konf.

<b>Test Certificates</b>	<b>Marine / Shipping</b>
<a href="#">Type Test Certificates/Test Report</a>	<a href="#">Special Test Certificate</a>
 ABS	 BUREAU VERITAS
	 LRS
	 PRS

<b>Marine / Shipping</b>	<b>other</b>
 RINA	<a href="#">Confirmation</a>
 RMRS	 VDE
 DNV-GL	<a href="#">Miscellaneous</a>

### Railway

[Vibration and Shock](#)

### Further information

- Information- and Downloadcenter (Catalogs, Brochures,...)**  
<http://www.siemens.com/industrial-controls/catalogs>
- Industry Mall (Online ordering system)**  
<https://mall.industry.siemens.com/mall/en/en/Catalog/product?mlfb=3RV2311-0DC10>
- Cax online generator**  
<http://support.automation.siemens.com/WW/CAXorder/default.aspx?lang=en&mlfb=3RV2311-0DC10>
- Service&Support (Manuals, Certificates, Characteristics, FAQs,...)**  
<https://support.industry.siemens.com/cs/ww/en/ps/3RV2311-0DC10>
- Image database (product images, 2D dimension drawings, 3D models, device circuit diagrams, EPLAN macros, ...)**  
[http://www.automation.siemens.com/bilddb/cax\\_de.aspx?mlfb=3RV2311-0DC10&lang=en](http://www.automation.siemens.com/bilddb/cax_de.aspx?mlfb=3RV2311-0DC10&lang=en)

**Characteristic: Tripping characteristics, I<sup>2</sup>t, Let-through current**

<https://support.industry.siemens.com/cs/ww/en/ps/3RV2311-0DC10/char>

**Further characteristics (e.g. electrical endurance, switching frequency)**

<http://www.automation.siemens.com/bilddb/index.aspx?view=Search&mlfb=3RV2311-0DC10&objecttype=14&gridview=view1>

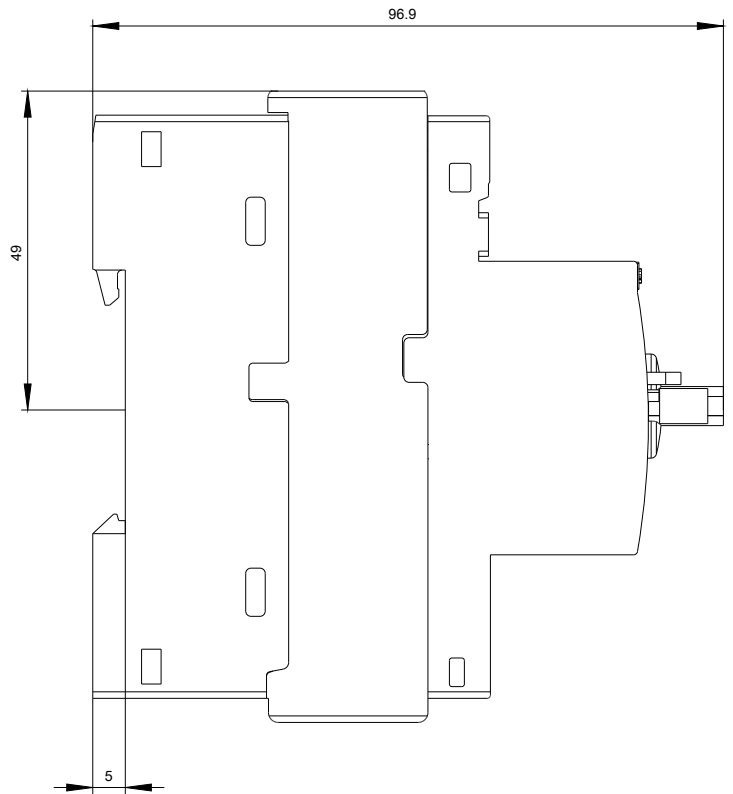
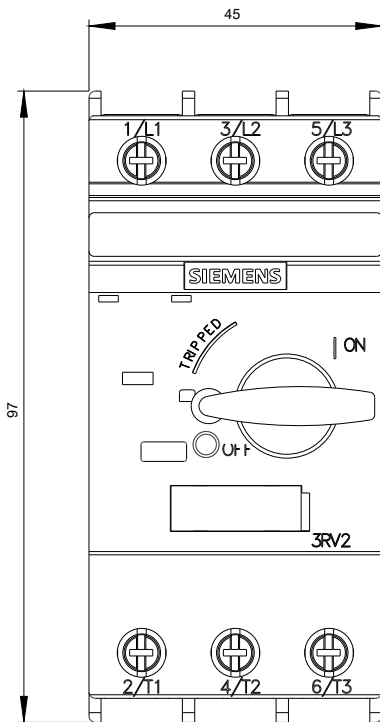

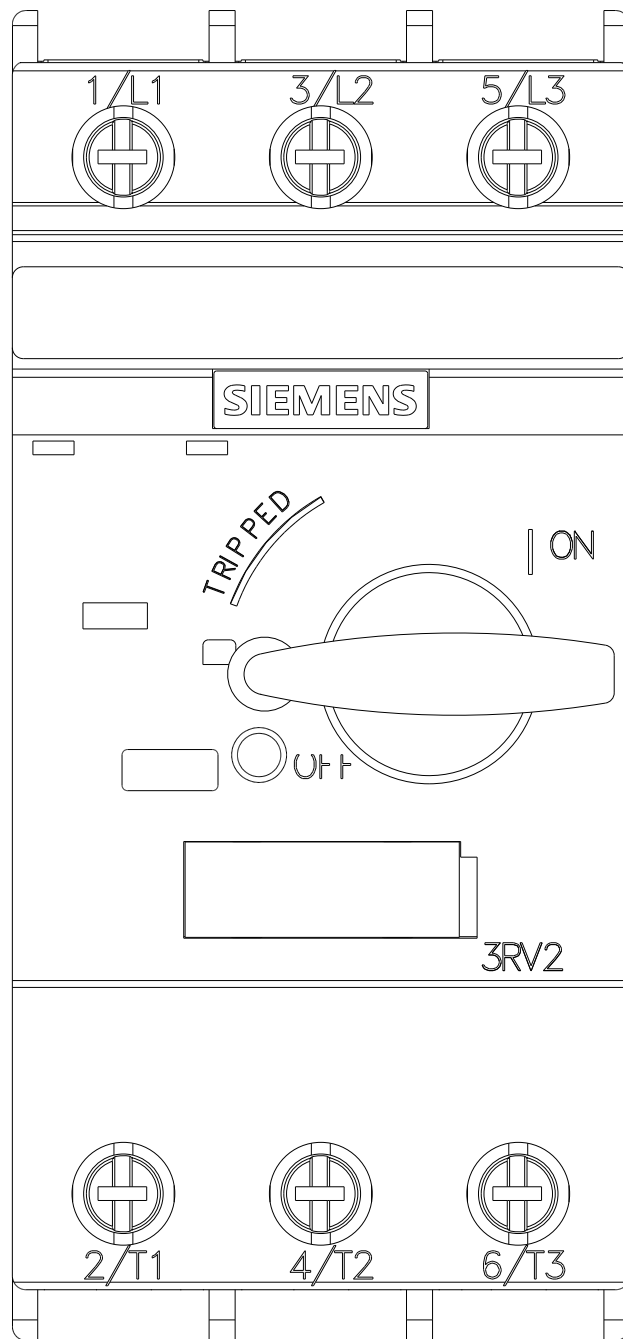

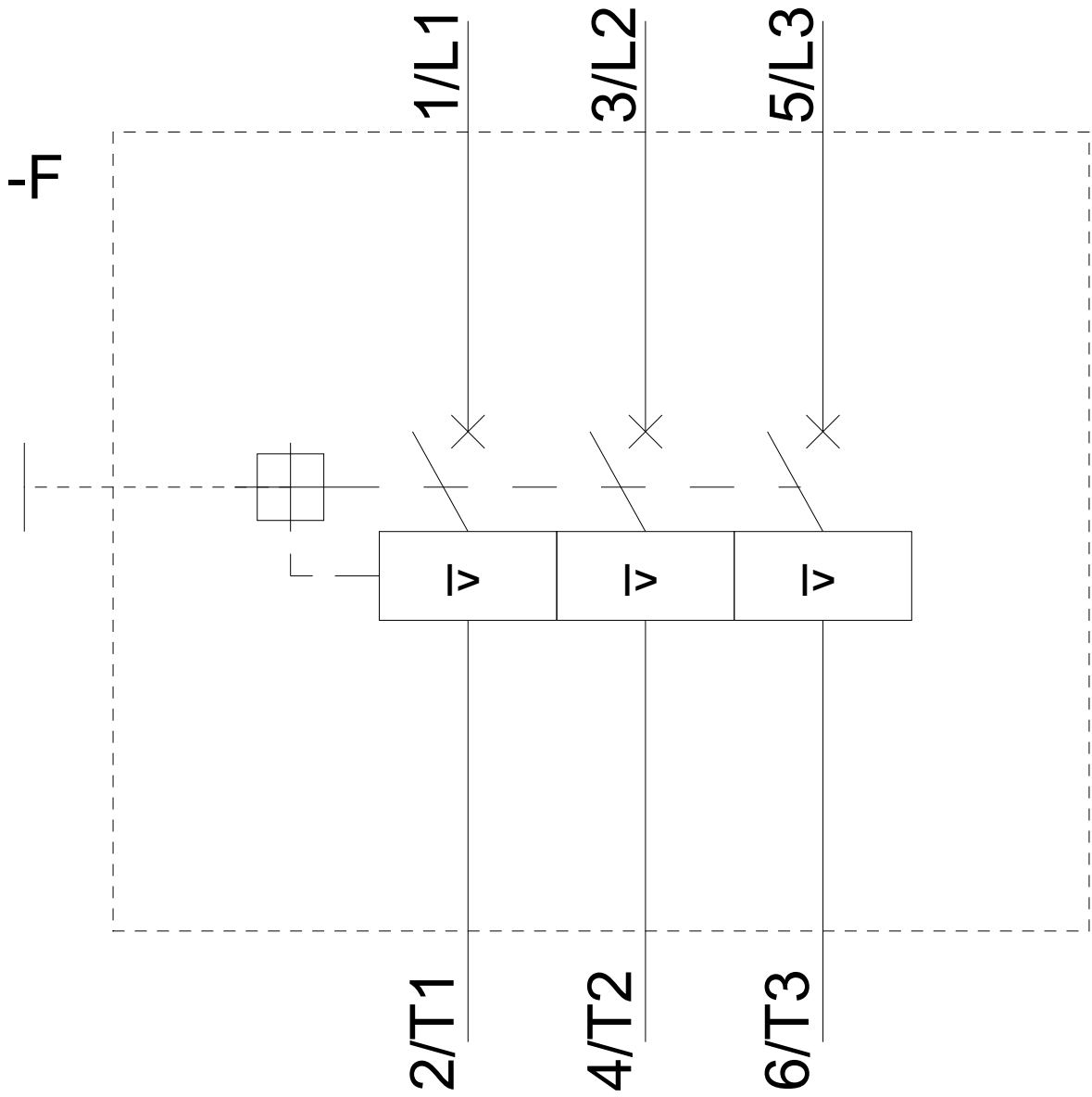

last modified:

08/04/2018