

CIRCUIT-BREAKER SZ S0, FOR STARTER COMBINATION,
 RATED CURRENT 16A, N-RELEASE 208A, SCREW
 CONNECTION, STANDARD SW. CAPACITY



product brandname	SIRIUS
Product designation	Circuit breaker
Design of the product	For starter combinations
Product type designation	3RV2

General technical data	
Size of the circuit-breaker	S0
Size of contactor can be combined company-specific	S00, S0
Product extension	
• Auxiliary switch	Yes
Power loss [W] total typical	7 W
Insulation voltage with degree of pollution 3 rated value	690 V
Surge voltage resistance rated value	6 kV
maximum permissible voltage for safe isolation	
• in networks with grounded star point between main and auxiliary circuit	400 V
• in networks with grounded star point between main and auxiliary circuit	400 V
Protection class IP	

<ul style="list-style-type: none"> • on the front • of the terminal 	IP20 IP20
Shock resistance	
<ul style="list-style-type: none"> • acc. to IEC 60068-2-27 	25g / 11 ms
Mechanical service life (switching cycles)	
<ul style="list-style-type: none"> • of the main contacts typical • of auxiliary contacts typical 	100 000 100 000
Electrical endurance (switching cycles)	
<ul style="list-style-type: none"> • typical 	100 000
Certificate of suitability relating to ATEX	on request
Protection against electrical shock	finger-safe
Equipment marking acc. to DIN EN 81346-2	Q

Ambient conditions

Installation altitude at height above sea level maximum	2 000 m
Ambient temperature	
<ul style="list-style-type: none"> • during operation • during storage • during transport 	-20 ... +60 °C -50 ... +80 °C -50 ... +80 °C
Relative humidity during operation	10 ... 95 %

Main circuit

Number of poles for main current circuit	3
Operating voltage	
<ul style="list-style-type: none"> • rated value • at AC-3 rated value maximum 	690 V 690 V
Operating frequency rated value	50 ... 60 Hz
Operating current rated value	16 A
Operating current	
<ul style="list-style-type: none"> • at AC-3 <ul style="list-style-type: none"> — at 400 V rated value 	16 A
Operating power	
<ul style="list-style-type: none"> • at AC-3 <ul style="list-style-type: none"> — at 230 V rated value — at 400 V rated value — at 500 V rated value — at 690 V rated value 	4 000 W 7 500 W 7 500 W 11 000 W
Operating frequency	
<ul style="list-style-type: none"> • at AC-3 maximum 	15 1/h

Auxiliary circuit

Number of NC contacts	
<ul style="list-style-type: none"> • for auxiliary contacts 	0

Number of NO contacts	
• for auxiliary contacts	0
Number of CO contacts	
• for auxiliary contacts	0

Protective and monitoring functions

Operational short-circuit current breaking capacity (Ics) at AC	
• at 240 V rated value	100 kA
• at 400 V rated value	25 kA
• at 500 V rated value	5 kA
• at 690 V rated value	2 kA
Maximum short-circuit current breaking capacity (Icu)	
• at AC at 240 V rated value	100 kA
• at AC at 400 V rated value	55 kA
• at AC at 500 V rated value	10 kA
• at AC at 690 V rated value	4 kA
Breaking capacity short-circuit current (Icn)	
• at 1 current path at DC at 150 V rated value	10 kA
• with 2 current paths in series at DC at 300 V rated value	10 kA
• with 3 current paths in series at DC at 450 V rated value	10 kA

UL/CSA ratings

Full-load current (FLA) for three-phase AC motor	
• at 480 V rated value	16 A
• at 600 V rated value	16 A
Yielded mechanical performance [hp]	
• for single-phase AC motor	
— at 110/120 V rated value	1 hp
— at 230 V rated value	2 hp
• for three-phase AC motor	
— at 200/208 V rated value	3 hp
— at 220/230 V rated value	5 hp
— at 460/480 V rated value	10 hp

Short-circuit protection

Design of the short-circuit trip	magnetic
Design of the fuse link for IT network for short-circuit protection of the main circuit	
• at 400 V	gL/gG 63 A
• at 500 V	gL/gG 50 A
• at 690 V	gL/gG 40 A

Installation/ mounting/ dimensions







Mounting position	any
Mounting type	screw and snap-on mounting onto 35 mm standard mounting rail according to DIN EN 60715
Height	97 mm
Width	45 mm
Depth	96 mm
Required spacing	
<ul style="list-style-type: none"> • with side-by-side mounting <ul style="list-style-type: none"> — forwards — Backwards — upwards — downwards — at the side • for grounded parts <ul style="list-style-type: none"> — forwards — Backwards — upwards — at the side — downwards • for live parts <ul style="list-style-type: none"> — forwards — Backwards — upwards — downwards — at the side 	<ul style="list-style-type: none"> 0 mm 0 mm 50 mm 50 mm 0 mm 0 mm 0 mm 50 mm 30 mm 50 mm 0 mm 0 mm 50 mm 50 mm 30 mm





Connections/Terminals



Product function	
<ul style="list-style-type: none"> • removable terminal for auxiliary and control circuit 	No
Type of electrical connection	
<ul style="list-style-type: none"> • for main current circuit 	screw-type terminals
Arrangement of electrical connectors for main current circuit	Top and bottom
Type of connectable conductor cross-sections	
<ul style="list-style-type: none"> • for main contacts <ul style="list-style-type: none"> — single or multi-stranded — finely stranded with core end processing • at AWG conductors for main contacts 	<ul style="list-style-type: none"> 2x (1 ... 2,5 mm²), 2x (2,5 ... 10 mm²) 2x (1 ... 2.5 mm²), 2x (2.5 ... 6 mm²), 1x 10 mm² 2x (16 ... 12), 2x (14 ... 8)
Tightening torque	
<ul style="list-style-type: none"> • for main contacts with screw-type terminals 	2 ... 2.5 N·m
Design of screwdriver shaft	Diameter 5 to 6 mm

Design of the thread of the connection screw • for main contacts	M4
Safety related data	
B10 value • with high demand rate acc. to SN 31920	5 000
Proportion of dangerous failures • with low demand rate acc. to SN 31920 • with high demand rate acc. to SN 31920	50 % 50 %
Failure rate [FIT] • with low demand rate acc. to SN 31920	50 FIT
T1 value for proof test interval or service life acc. to IEC 61508	10 y
Display version • for switching status	Handle

Certificates/approvals

General Product Approval	Declaration of Conformity
 CCC	
 CSA	
 UL	 EG-Konf.

Test Certificates	Shipping Approval
Typprüfbescheinigung/Werkszeugnis spezielle Prüfbescheinigung n	 ABS
	 BUREAU VERITAS
	 LRS
	 PRS

Shipping Approval	other
 RINA	Bestätigungen
 RMRS	Umweltbestätigung
	 VDE
	sonstig

Railway
Schwingen/Schocke n

Further information

Information- and Downloadcenter (Catalogs, Brochures,...)

<http://www.siemens.com/industrial-controls/catalogs>

Industry Mall (Online ordering system)

<https://mall.industry.siemens.com/mall/en/en/Catalog/product?mfb=3RV2321-4AC10>

Cax online generator

<http://support.automation.siemens.com/WW/CAXorder/default.aspx?lang=en&mfb=3RV2321-4AC10>

Service&Support (Manuals, Certificates, Characteristics, FAQs,...)

<https://support.industry.siemens.com/cs/ww/en/ps/3RV2321-4AC10>

Image database (product images, 2D dimension drawings, 3D models, device circuit diagrams, EPLAN macros, ...)

http://www.automation.siemens.com/bilddb/cax_de.aspx?mfb=3RV2321-4AC10&lang=en

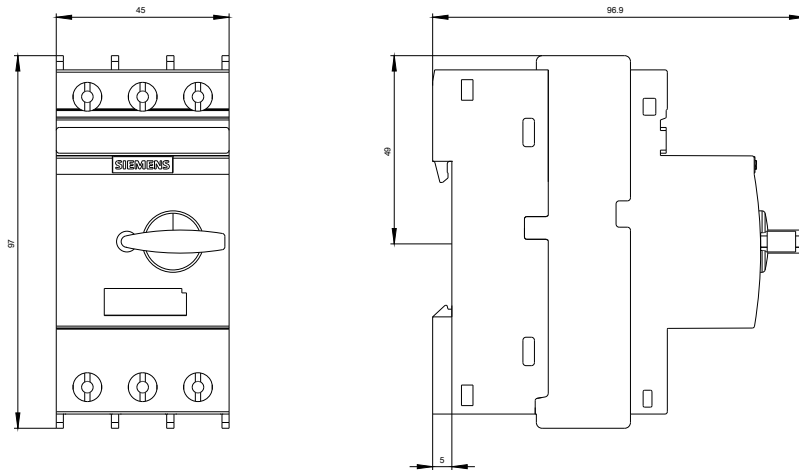

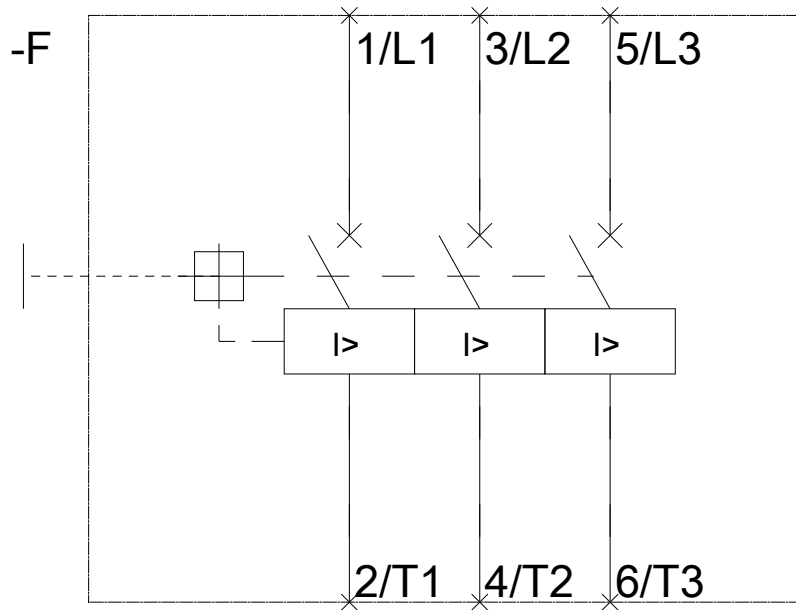
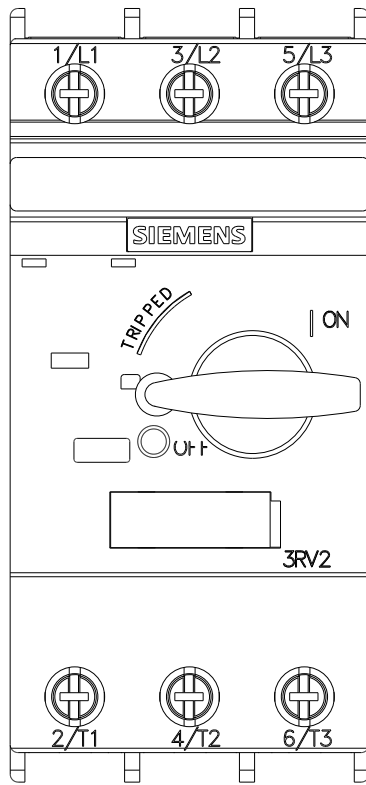

last modified:

11/24/2016