

CIRCUIT-BREAKER SZ S0, FOR STARTER COMBINATION, RATED CURRENT 32A, N-RELEASE 400A, SCREW CONNECTION, STANDARD SW. CAPACITY



product brandname	SIRIUS
Product designation	Circuit breaker
Design of the product	For starter combinations
Product type designation	3RV2

General technical data	
Size of the circuit-breaker	S0
Size of contactor can be combined company-specific	S00, S0
Product extension	
• Auxiliary switch	Yes
Power loss [W] total typical	11 W
Insulation voltage with degree of pollution 3 rated value	690 V
Surge voltage resistance rated value	6 kV
maximum permissible voltage for safe isolation	
• in networks with grounded star point between main and auxiliary circuit	400 V
• in networks with grounded star point between main and auxiliary circuit	400 V
Protection class IP	

<ul style="list-style-type: none"> • on the front • of the terminal 	<p>IP20</p> <p>IP20</p>
Shock resistance	
<ul style="list-style-type: none"> • acc. to IEC 60068-2-27 	25g / 11 ms
Mechanical service life (switching cycles)	
<ul style="list-style-type: none"> • of the main contacts typical • of auxiliary contacts typical 	<p>100 000</p> <p>100 000</p>
Electrical endurance (switching cycles)	
<ul style="list-style-type: none"> • typical 	100 000
Certificate of suitability relating to ATEX	on request
Protection against electrical shock	finger-safe
Equipment marking acc. to DIN EN 81346-2	Q

Ambient conditions

Installation altitude at height above sea level maximum	2 000 m
Ambient temperature	
<ul style="list-style-type: none"> • during operation • during storage • during transport 	<p>-20 ... +60 °C</p> <p>-50 ... +80 °C</p> <p>-50 ... +80 °C</p>
Relative humidity during operation	10 ... 95 %

Main circuit

Number of poles for main current circuit	3
Operating voltage	
<ul style="list-style-type: none"> • rated value • at AC-3 rated value maximum 	<p>690 V</p> <p>690 V</p>
Operating frequency rated value	50 ... 60 Hz
Operating current rated value	32 A
Operating current	
<ul style="list-style-type: none"> • at AC-3 <ul style="list-style-type: none"> — at 400 V rated value 	32 A
Operating power	
<ul style="list-style-type: none"> • at AC-3 <ul style="list-style-type: none"> — at 230 V rated value — at 400 V rated value — at 500 V rated value — at 690 V rated value 	<p>7 500 W</p> <p>15 000 W</p> <p>18 500 W</p> <p>30 000 W</p>
Operating frequency	
<ul style="list-style-type: none"> • at AC-3 maximum 	15 1/h

Auxiliary circuit

Number of NC contacts	
<ul style="list-style-type: none"> • for auxiliary contacts 	0

Number of NO contacts	
• for auxiliary contacts	0
Number of CO contacts	
• for auxiliary contacts	0

Protective and monitoring functions

Operational short-circuit current breaking capacity (Ics) at AC	
• at 240 V rated value	100 kA
• at 400 V rated value	25 kA
• at 500 V rated value	5 kA
• at 690 V rated value	2 kA
Maximum short-circuit current breaking capacity (Icu)	
• at AC at 240 V rated value	100 kA
• at AC at 400 V rated value	55 kA
• at AC at 500 V rated value	10 kA
• at AC at 690 V rated value	4 kA
Breaking capacity short-circuit current (Icn)	
• at 1 current path at DC at 150 V rated value	10 kA
• with 2 current paths in series at DC at 300 V rated value	10 kA
• with 3 current paths in series at DC at 450 V rated value	10 kA

UL/CSA ratings

Full-load current (FLA) for three-phase AC motor	
• at 480 V rated value	32 A
• at 600 V rated value	32 A
Yielded mechanical performance [hp]	
• for single-phase AC motor	
— at 110/120 V rated value	2 hp
— at 230 V rated value	5 hp
• for three-phase AC motor	
— at 200/208 V rated value	7.5 hp
— at 220/230 V rated value	10 hp
— at 460/480 V rated value	20 hp

Short-circuit protection

Design of the short-circuit trip	magnetic
Design of the fuse link for IT network for short-circuit protection of the main circuit	
• at 400 V	gL/gG 63 A
• at 500 V	gL/gG 63 A
• at 690 V	gL/gG 63 A

Installation/ mounting/ dimensions





Mounting position	any
Mounting type	screw and snap-on mounting onto 35 mm standard mounting rail according to DIN EN 60715
Height	97 mm
Width	45 mm
Depth	96 mm
Required spacing	
<ul style="list-style-type: none"> • with side-by-side mounting <ul style="list-style-type: none"> — forwards 0 mm — Backwards 0 mm — upwards 50 mm — downwards 50 mm — at the side 0 mm • for grounded parts <ul style="list-style-type: none"> — forwards 0 mm — Backwards 0 mm — upwards 50 mm — at the side 30 mm — downwards 50 mm • for live parts <ul style="list-style-type: none"> — forwards 0 mm — Backwards 0 mm — upwards 50 mm — downwards 50 mm — at the side 30 mm 	





Connections/Terminals

Product function	
<ul style="list-style-type: none"> • removable terminal for auxiliary and control circuit 	No
Type of electrical connection	
<ul style="list-style-type: none"> • for main current circuit 	screw-type terminals
Arrangement of electrical connectors for main current circuit	Top and bottom
Type of connectable conductor cross-sections	
<ul style="list-style-type: none"> • for main contacts <ul style="list-style-type: none"> — single or multi-stranded 2x (1 ... 2,5 mm²), 2x (2,5 ... 10 mm²) — finely stranded with core end processing 2x (1 ... 2.5 mm²), 2x (2.5 ... 6 mm²), 1x 10 mm² • at AWG conductors for main contacts 2x (16 ... 12), 2x (14 ... 8) 	
Tightening torque	
<ul style="list-style-type: none"> • for main contacts with screw-type terminals 	2 ... 2.5 N·m
Design of screwdriver shaft	Diameter 5 to 6 mm

Design of the thread of the connection screw • for main contacts	M4
Safety related data	
B10 value • with high demand rate acc. to SN 31920	5 000
Proportion of dangerous failures • with low demand rate acc. to SN 31920 • with high demand rate acc. to SN 31920	50 % 50 %
Failure rate [FIT] • with low demand rate acc. to SN 31920	50 FIT
T1 value for proof test interval or service life acc. to IEC 61508	10 y
Display version • for switching status	Handle

Certificates/approvals

General Product Approval	Declaration of Conformity
 CCC  CSA  UL KTL	 EAC  CE EG-Konf.

Test Certificates spezielle Prüfbescheinigung n	Shipping Approval Typprüfbescheinigung/Werkszeugnis  ABS  BUREAU VERITAS  LRS  PRS
--	--

Shipping Approval  RINA  RMRS	other Umweltbestätigung Bestätigungen  VDE sonstig
--	--

Railway Schwingen/Schocke n
--

Further information

Information- and Downloadcenter (Catalogs, Brochures,...)

<http://www.siemens.com/industrial-controls/catalogs>

Industry Mall (Online ordering system)

<https://mall.industry.siemens.com/mall/en/en/Catalog/product?mfb=3RV2321-4EC10>

Cax online generator

<http://support.automation.siemens.com/WW/CAXorder/default.aspx?lang=en&mfb=3RV2321-4EC10>

Service&Support (Manuals, Certificates, Characteristics, FAQs,...)

<https://support.industry.siemens.com/cs/ww/en/ps/3RV2321-4EC10>

Image database (product images, 2D dimension drawings, 3D models, device circuit diagrams, EPLAN macros, ...)

http://www.automation.siemens.com/bilddb/cax_de.aspx?mfb=3RV2321-4EC10&lang=en

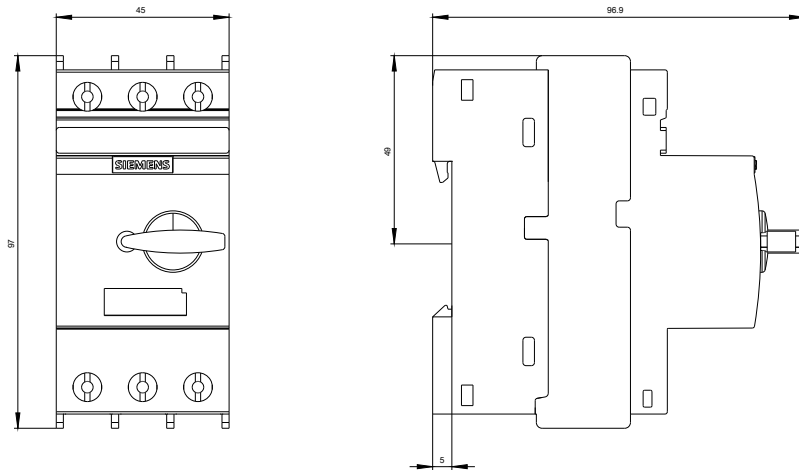

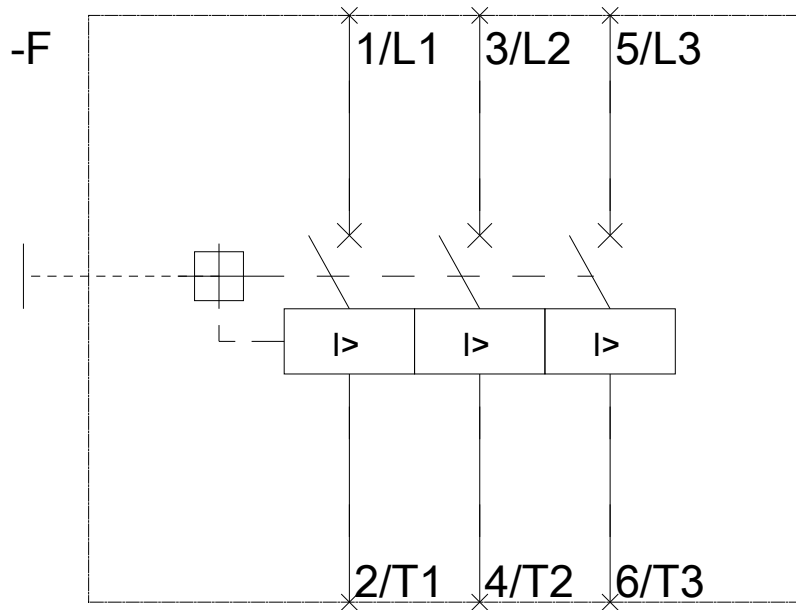
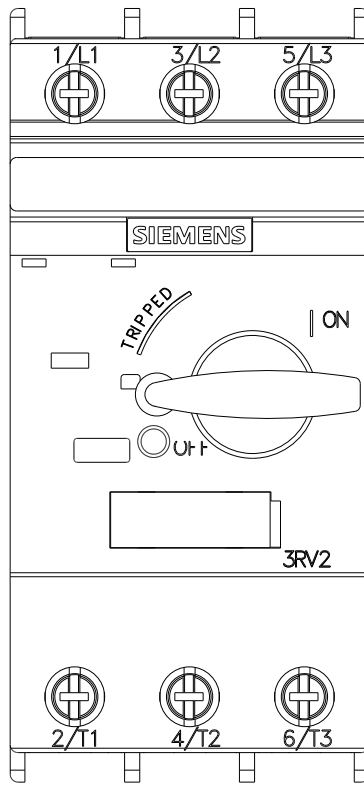

last modified:

11/22/2016