

CIRCUIT-BREAKER SZ S0, FOR STARTER COMBINATION,  
RATED CURRENT 40A, N-RELEASE 480A, SCREW  
CONNECTION, STANDARD SW. CAPACITY



product brandname	SIRIUS
Product designation	Circuit breaker
Design of the product	For starter combinations
Product type designation	3RV2

General technical data	
Size of the circuit-breaker	S0
Size of contactor can be combined company-specific	S00, S0
Product extension	
• Auxiliary switch	Yes
Power loss [W] total typical	14 W
Insulation voltage with degree of pollution 3 rated value	690 V
Surge voltage resistance rated value	6 kV
maximum permissible voltage for safe isolation	
• in networks with grounded star point between main and auxiliary circuit	400 V
• in networks with grounded star point between main and auxiliary circuit	400 V
Protection class IP	

<ul style="list-style-type: none"> <li>• on the front</li> <li>• of the terminal</li> </ul>	IP20 IP20
<b>Shock resistance</b>	
<ul style="list-style-type: none"> <li>• acc. to IEC 60068-2-27</li> </ul>	25g / 11 ms
<b>Mechanical service life (switching cycles)</b>	
<ul style="list-style-type: none"> <li>• of the main contacts typical</li> <li>• of auxiliary contacts typical</li> </ul>	100 000 100 000
<b>Electrical endurance (switching cycles)</b>	
<ul style="list-style-type: none"> <li>• typical</li> </ul>	100 000
<b>Certificate of suitability relating to ATEX</b>	on request
<b>Protection against electrical shock</b>	finger-safe
Equipment marking acc. to DIN EN 81346-2	Q

#### Ambient conditions

<b>Installation altitude at height above sea level maximum</b>	2 000 m
<b>Ambient temperature</b>	
<ul style="list-style-type: none"> <li>• during operation</li> <li>• during storage</li> <li>• during transport</li> </ul>	-20 ... +60 °C -50 ... +80 °C -50 ... +80 °C
<b>Relative humidity during operation</b>	10 ... 95 %

#### Main circuit

<b>Number of poles for main current circuit</b>	3
<b>Operating voltage</b>	
<ul style="list-style-type: none"> <li>• rated value</li> <li>• at AC-3 rated value maximum</li> </ul>	690 V 690 V
<b>Operating frequency rated value</b>	50 ... 60 Hz
<b>Operating current rated value</b>	40 A
<b>Operating current</b>	
<ul style="list-style-type: none"> <li>• at AC-3 <ul style="list-style-type: none"> <li>— at 400 V rated value</li> </ul> </li> </ul>	40 A
<b>Operating power</b>	
<ul style="list-style-type: none"> <li>• at AC-3 <ul style="list-style-type: none"> <li>— at 230 V rated value</li> <li>— at 400 V rated value</li> <li>— at 500 V rated value</li> <li>— at 690 V rated value</li> </ul> </li> </ul>	11 000 W 18 500 W 22 000 W 39 000 W
<b>Operating frequency</b>	
<ul style="list-style-type: none"> <li>• at AC-3 maximum</li> </ul>	15 1/h

#### Auxiliary circuit

<b>Number of NC contacts</b>	
<ul style="list-style-type: none"> <li>• for auxiliary contacts</li> </ul>	0

<b>Number of NO contacts</b>	
• for auxiliary contacts	0
<b>Number of CO contacts</b>	
• for auxiliary contacts	0

### Protective and monitoring functions

<b>Operational short-circuit current breaking capacity (Ics) at AC</b>	
• at 240 V rated value	100 kA
• at 400 V rated value	10 kA
• at 500 V rated value	3 kA
• at 690 V rated value	2 kA
<b>Maximum short-circuit current breaking capacity (Icu)</b>	
• at AC at 240 V rated value	100 kA
• at AC at 400 V rated value	20 kA
• at AC at 500 V rated value	6 kA
• at AC at 690 V rated value	3 kA
<b>Breaking capacity short-circuit current (Icn)</b>	
• at 1 current path at DC at 150 V rated value	10 kA
• with 2 current paths in series at DC at 300 V rated value	10 kA
• with 3 current paths in series at DC at 450 V rated value	10 kA

### UL/CSA ratings

<b>Full-load current (FLA) for three-phase AC motor</b>	
• at 480 V rated value	40 A
• at 600 V rated value	40 A
<b>Yielded mechanical performance [hp]</b>	
• for single-phase AC motor	
— at 110/120 V rated value	3 hp
— at 230 V rated value	7.5 hp
• for three-phase AC motor	
— at 200/208 V rated value	10 hp
— at 220/230 V rated value	10 hp
— at 460/480 V rated value	30 hp

### Short-circuit protection

<b>Design of the short-circuit trip</b>	magnetic
<b>Design of the fuse link for IT network for short-circuit protection of the main circuit</b>	
• at 400 V	gL/gG 63 A
• at 500 V	gL/gG 63 A
• at 690 V	gL/gG 63 A

## Installation/ mounting/ dimensions







<b>Mounting position</b>	any
<b>Mounting type</b>	screw and snap-on mounting onto 35 mm standard mounting rail according to DIN EN 60715
<b>Height</b>	97 mm
<b>Width</b>	45 mm
<b>Depth</b>	96 mm
<b>Required spacing</b>	
<ul style="list-style-type: none"> <li>• with side-by-side mounting           <ul style="list-style-type: none"> <li>— forwards 0 mm</li> <li>— Backwards 0 mm</li> <li>— upwards 50 mm</li> <li>— downwards 50 mm</li> <li>— at the side 0 mm</li> </ul> </li> <li>• for grounded parts           <ul style="list-style-type: none"> <li>— forwards 0 mm</li> <li>— Backwards 0 mm</li> <li>— upwards 50 mm</li> <li>— at the side 30 mm</li> <li>— downwards 50 mm</li> </ul> </li> <li>• for live parts           <ul style="list-style-type: none"> <li>— forwards 0 mm</li> <li>— Backwards 0 mm</li> <li>— upwards 50 mm</li> <li>— downwards 50 mm</li> <li>— at the side 30 mm</li> </ul> </li> </ul>	





## Connections/Terminals



<b>Product function</b>	
<ul style="list-style-type: none"> <li>• removable terminal for auxiliary and control circuit</li> </ul>	No
<b>Type of electrical connection</b>	
<ul style="list-style-type: none"> <li>• for main current circuit</li> </ul>	screw-type terminals
<b>Arrangement of electrical connectors for main current circuit</b>	Top and bottom
<b>Type of connectable conductor cross-sections</b>	
<ul style="list-style-type: none"> <li>• for main contacts           <ul style="list-style-type: none"> <li>— single or multi-stranded 2x (1 ... 2,5 mm<sup>2</sup>), 2x (2,5 ... 10 mm<sup>2</sup>)</li> <li>— finely stranded with core end processing 2x (1 ... 2.5 mm<sup>2</sup>), 2x (2.5 ... 6 mm<sup>2</sup>), 1x 10 mm<sup>2</sup></li> </ul> </li> <li>• at AWG conductors for main contacts 2x (16 ... 12), 2x (14 ... 8)</li> </ul>	
<b>Tightening torque</b>	
<ul style="list-style-type: none"> <li>• for main contacts with screw-type terminals</li> </ul>	2 ... 2.5 N·m
<b>Design of screwdriver shaft</b>	Diameter 5 to 6 mm

<b>Design of the thread of the connection screw</b> • for main contacts	M4
<b>Safety related data</b>	
<b>B10 value</b> • with high demand rate acc. to SN 31920	5 000
<b>Proportion of dangerous failures</b> • with low demand rate acc. to SN 31920 • with high demand rate acc. to SN 31920	50 % 50 %
<b>T1 value for proof test interval or service life acc. to IEC 61508</b>	10 y
<b>Display version</b> • for switching status	Handle

### Certificates/approvals

<b>General Product Approval</b>	<b>Declaration of Conformity</b>
 CCC	 CSA
 UL	 EAC
 KTL	 EG-Konf.

<b>Test Certificates</b>	<b>Shipping Approval</b>
<a href="#">Typprüfbescheinigung/Werkszeugnis</a> <a href="#">spezielle Prüfbescheinigung</a> <a href="#">n</a>	 ABS
	 BUREAU VERITAS
	 LRS
	 PRS

<b>Shipping Approval</b>	<b>other</b>
 RINA	<a href="#">Bestätigungen</a>
 RMRS	<a href="#">Umweltbestätigung</a>
	 VDE
	<a href="#">sonstig</a>

<b>Railway</b>
<a href="#">Schwingen/Schocke</a> <a href="#">n</a>

### Further information

**Information- and Downloadcenter (Catalogs, Brochures,...)**  
<http://www.siemens.com/industrial-controls/catalogs>

**Industry Mall (Online ordering system)**

<https://mall.industry.siemens.com/mall/en/en/Catalog/product?mlfb=3RV2321-4FC10>

**Cax online generator**

<http://support.automation.siemens.com/WW/CAXorder/default.aspx?lang=en&mlfb=3RV2321-4FC10>

**Service&Support (Manuals, Certificates, Characteristics, FAQs,...)**

<https://support.industry.siemens.com/cs/ww/en/ps/3RV2321-4FC10>

**Image database (product images, 2D dimension drawings, 3D models, device circuit diagrams, EPLAN macros, ...)**

[http://www.automation.siemens.com/bilddb/cax\\_de.aspx?mlfb=3RV2321-4FC10&lang=en](http://www.automation.siemens.com/bilddb/cax_de.aspx?mlfb=3RV2321-4FC10&lang=en)

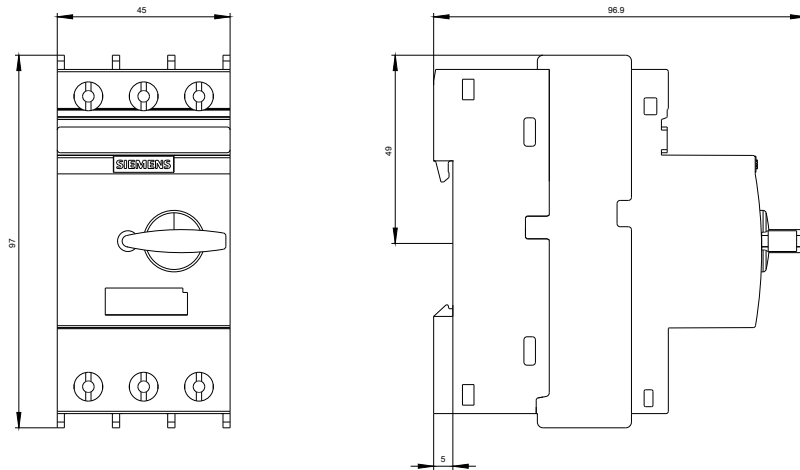

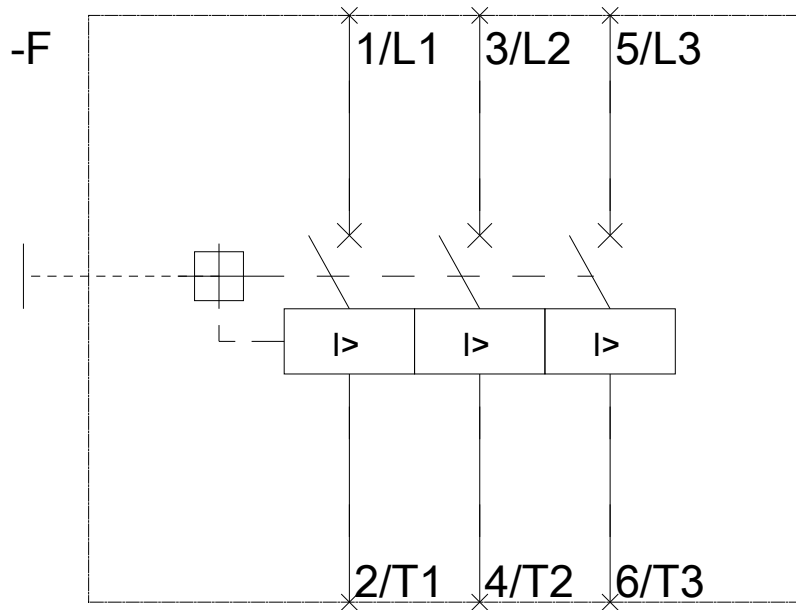
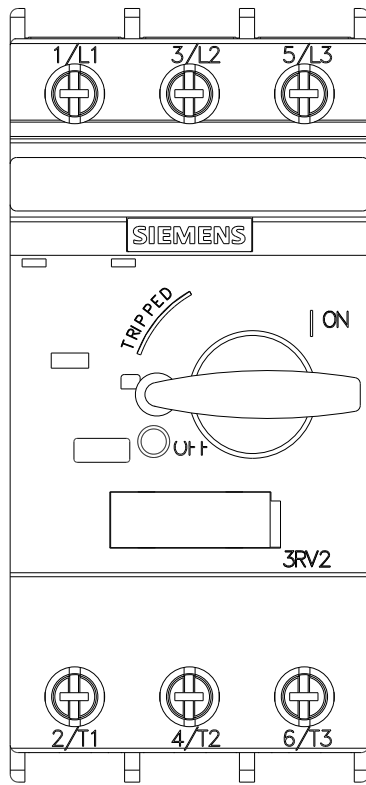

last modified:

11/24/2016