

Operator panel titanium gray, installation in control cabinet door or front plate, can be plugged onto basic unit or extension modules, 10 LEDs for status display and 5 freely assignable keys for manual control



Figure similar

<b>Product brand name</b>	SIRIUS
<b>Product designation</b>	operator panels
<b>General technical data</b>	
<b>Insulation voltage</b>	
• rated value	300 V
<b>Surge voltage resistance rated value</b>	4 000 V
<b>Protection class IP</b>	
• on the front	IP54
<b>Vibration resistance</b>	1-6 Hz / 15 mm; 6-500 Hz / 2 g
<b>Electromagnetic compatibility</b>	
<b>EMC emitted interference</b>	
• acc. to IEC 60947-1	class A
<b>EMI immunity acc. to IEC 60947-1</b>	corresponds to degree of severity 3
<b>Conducted interference</b>	
• due to burst acc. to IEC 61000-4-4	1 kV
• due to conductor-earth surge acc. to IEC 61000-4-5	2 kV

<ul style="list-style-type: none"> <li>• due to conductor-conductor surge acc. to IEC 61000-4-5</li> </ul>	1 kV
<b>Field-bound parasitic coupling acc. to IEC 61000-4-3</b>	10 V/m





### Installation/ mounting/ dimensions





<b>Mounting position</b>	any
<b>Mounting type</b>	front mounting
<b>Height</b>	36 mm
<b>Width</b>	96 mm
<b>Depth</b>	44 mm

### Ambient conditions

<b>Installation altitude at height above sea level</b>	
<ul style="list-style-type: none"> <li>• maximum</li> </ul>	4 000 m
<ul style="list-style-type: none"> <li>• 1 maximum</li> </ul>	2 000 m
<ul style="list-style-type: none"> <li>• 2 maximum</li> </ul>	3 000 m; No protective separation at 50 °C
<ul style="list-style-type: none"> <li>• 3 maximum</li> </ul>	4 000 m; No protective separation at 40 °C
<b>Ambient temperature</b>	
<ul style="list-style-type: none"> <li>• during operation</li> </ul>	-25 ... +60 °C
<ul style="list-style-type: none"> <li>• during storage</li> </ul>	-40 ... +80 °C
<ul style="list-style-type: none"> <li>• during transport</li> </ul>	-40 ... +80 °C
<b>Environmental category</b>	
<ul style="list-style-type: none"> <li>• during operation acc. to IEC 60721</li> </ul>	3K6 (no formation of ice, no condensation, relative humidity 10 ... 95%), 3C3 (no salt mist), 3S2 (sand must not get into the devices), 3M6
<ul style="list-style-type: none"> <li>• during storage acc. to IEC 60721</li> </ul>	1K6 (no condensation, relative humidity 10 ... 95%), 1C2 (no salt mist), 1S2 (sand must not get into the devices), 1M4
<ul style="list-style-type: none"> <li>• during transport acc. to IEC 60721</li> </ul>	2K2, 2C1, 2S1, 2M2

### Certificates/approvals

General Product Approval		EMC	Declaration of Conformity	Test Certificates
 CSA	 UL		 C-Tick	 EG-Konf.
				<a href="#">Special Test Certificate</a>

Test Certificates	Marine / Shipping			other
<a href="#">Type Test Certificates/Test Report</a>	 ABS	 GL	 RMRS	 DNV-GL DNVGL.COM/AF
				<a href="#">Confirmation</a>

other	
<a href="#">PROFIsafe-Certification</a>	<a href="#">PROFINET-Certification</a>
 Profibus	

### Further information

**Information- and Downloadcenter (Catalogs, Brochures,...)**

<http://www.siemens.com/industrial-controls/catalogs>

**Industry Mall (Online ordering system)**

<https://mall.industry.siemens.com/mall/en/en/Catalog/product?mlfb=3UF7200-1AA01-0>

**Cax online generator**

<http://support.automation.siemens.com/WW/CAXorder/default.aspx?lang=en&mlfb=3UF7200-1AA01-0>

**Service&Support (Manuals, Certificates, Characteristics, FAQs,...)**

<https://support.industry.siemens.com/cs/ww/en/ps/3UF7200-1AA01-0>

**Image database (product images, 2D dimension drawings, 3D models, device circuit diagrams, EPLAN macros, ...)**

[http://www.automation.siemens.com/bilddb/cax\\_de.aspx?mlfb=3UF7200-1AA01-0&lang=en](http://www.automation.siemens.com/bilddb/cax_de.aspx?mlfb=3UF7200-1AA01-0&lang=en)

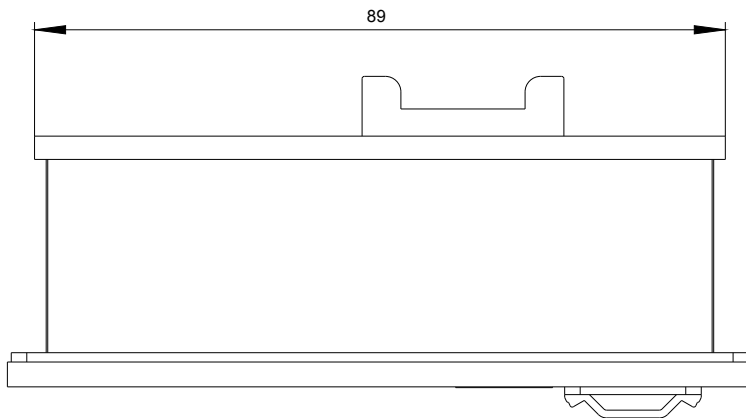
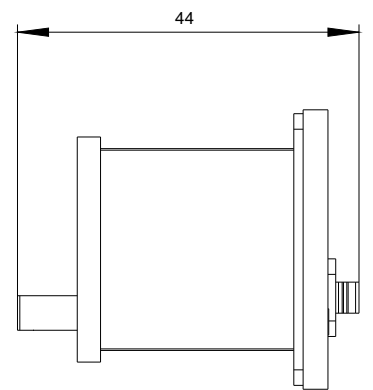
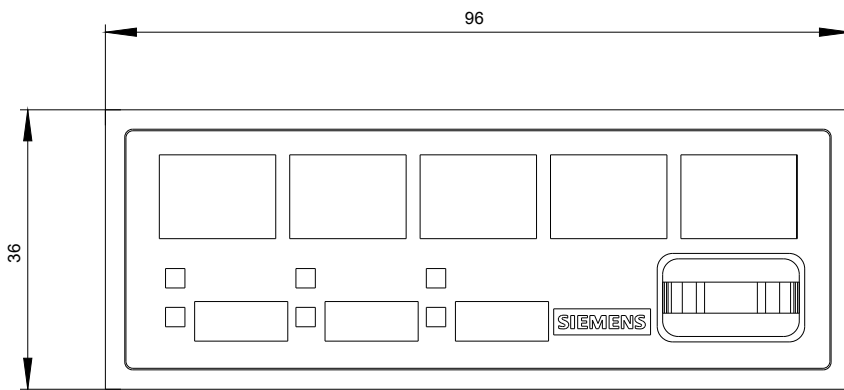

-K

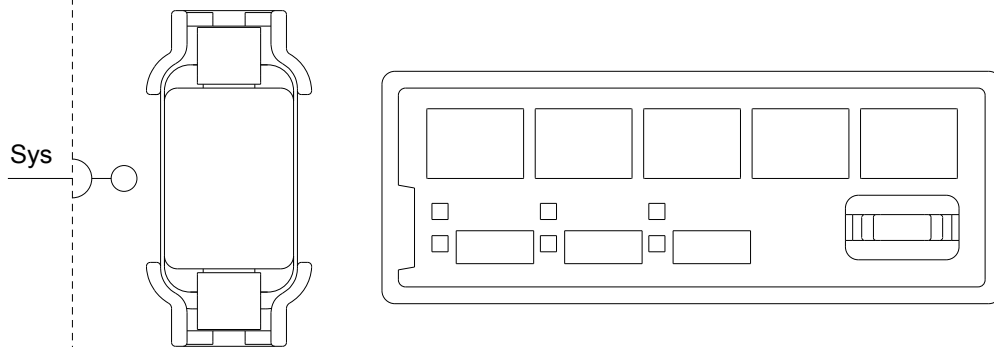

## SIMOCODE PRO

last modified:

08/28/2018