

Safety and security

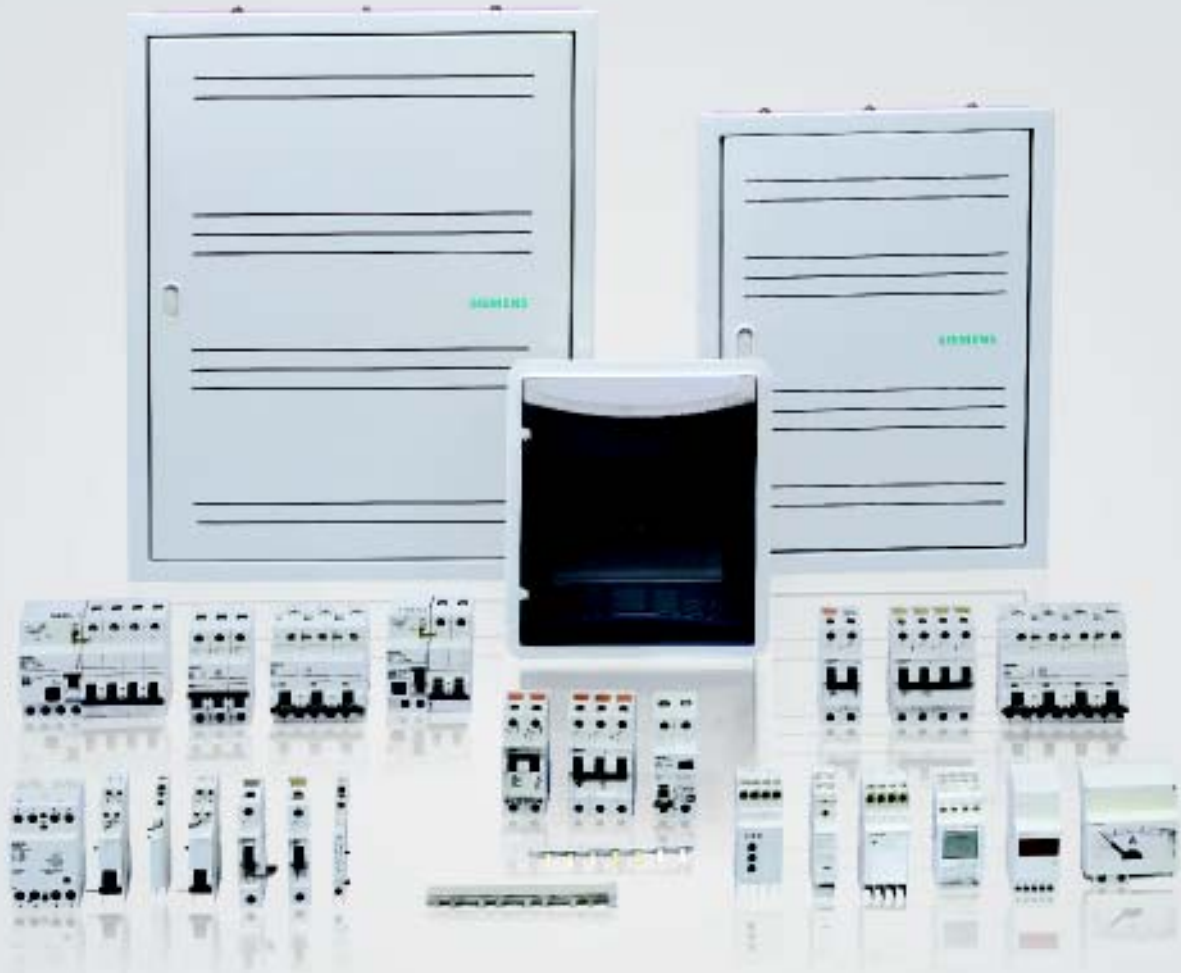

Betagard

www.siemens.com/industry

SIEMENS

1	Betagard Miniature Circuit Breakers & Betagard DC Circuit Breakers
1/2	Overview
1/6	Technical data
1/9	Selection & ordering data
1/13	Additional components
1/16	Dimensions
2	Betagard Residual Current Breaker Operator
2/2	Overview
2/3	Technical specifications
2/4	Product overview
2/6	Additional components
2/8	Dimensions

3	Betagard Distributions Boards
3/2	Design, construction and features
3/4	Selection and ordering data
3/7	Dimensions
3/16	Wiring instructions
4	Automatic Transfer Switching Equipment - ATSE
4/2	Overview
4/3	Selection & ordering
4/4	Technical specifications
4/5	ATSE types
4/6	Dimensional details
4/7	Schematics
4/8	ATSE in a power distribution

Betagard Miniature Circuit Breakers & Betagard DC Circuit Breakers



Small on size, big on protection



1/2	Overview
1/6	Technical data
1/9	Selection & ordering data
1/13	Additional components
1/16	Dimensions



Overview

Miniature Circuit Breakers (MCBs) : Type 5SX4

General

Betagard 5SX4 range of MCBs have rated breaking capacity of 10kA. They comply to the latest national and international standards, with current ratings from 0.5A to 63A.

For applications in industry and in system and plant engineering, add-on accessories are available, such as auxiliary contacts (AC), fault-signal contacts (FC) and shunt trips (ST).

Short circuit operation

At high values of overcurrent (i.e. short circuit current) a plunger in the solenoid is moved with sufficient force to physically separate the contacts. The greater the short circuit current, the greater the force with which the plunger is moved and faster the circuit is disconnected. A secondary action will ensure that the circuit breaker mechanism is tripped and prevents the contacts from reclosing. It is the rapid speed with which the contacts are forced apart coupled with other features of MCBs, which provides the Current limiting capability and safe interruption up to 10,000A.

The rapid speed at which the contacts are parted prevents the fault current from reaching its prospective value. The arc drawn between the contacts is moved by magnetic forces into the multiple plate arc chamber where the arc is split, rapidly cooled and extinguished. The total operating time of the MCB is between 3 to 5 milliseconds. The energy let through (I^2t) of the device is kept to a minimum thus offering a very high degree of protection.

Current limiting class 3

5SX4 type MCBs significantly limit the let-through current (when a fault occurs) due to the ultra – fast contact separation and the quick quenching of the emergency arc in the chamber. Thus, generally, they fall below the permissible limiting I^2t values of the energy limiting class 3, specified in DIN VDE 0641 Part II by 50%. This guarantees excellent discrimination with the upstream protective devices and reduces the thermal stress on the downstream connected equipments.

Chart indicates the let through energy values of 10kA, 16A MCB according to EN 60898.

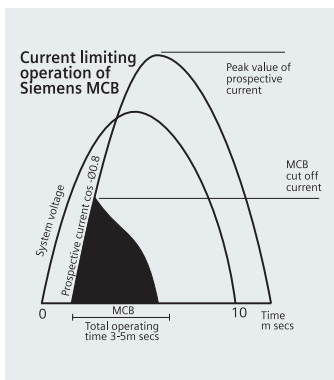

This MCB (16Amps) will allow only 50% of 84,000 (A²S) let-through energy thereby reducing thermal stress to bare minimum value on the downstream equipment.

As these MCBs meet the requirements of current limiting class 3, according



to EN 60898 without difficulty, they are therefore marked with symbol $\frac{10000}{3}$

Standards

According to IS 8828 (1996), IEC 60898 (1995), VDE 0641/ 6.78.

Features at a glance

- Current limiting class 3 type breakers.
- “C” / “D” tripping characteristics.
- Service life : Average 20,000 operations at rated load.
- Suitable for AC and DC circuits.
- Wide range of Add on accessories.
- Trip Free mechanism.
- Better selectivity.
- Finger Touch Proof Terminals, provide installation safety.
- Totally safe and dependable - computer calibrated testing.
- Recessed ON – OFF lever ensuring no accidental operation.
- Combined terminals allow busbar and feeder cable to be simultaneously connected.
- ON-OFF Lever sealable in ON and OFF position.
- Can be mounted in any position.

Rated Current	Current Limiting Class according to EN 60898		
	1	2	3
16 A	Permissible let-through I^2t (A ² S)		
	No limit	2,90,000	84,000

Rated Breaking Capacity :

		As per IEC 60898 / IS 8828	As per IEC 60947-2			As per UL 489
Rated Current I_n (A)		1P, 2P, 3P, 4P 230V AC, 415V I_{cn} (kA)	1P 230V AC I_{cn} (kA)	2P, 3P, 4P 230V AC, I_{cn} (kA)	1P, 2P, 3P, 4P 415 AC, I_{cn} (kA)	1P, 2P, 3P, 4P 415 AC, I_{cn} (kA)
5SX4	0.5 - 6	10	50	50	50	50
	10 - 20	10	25	30	25	50
	25 - 32	10	20	25	20	50
	40 - 63	10	10	15	10	–

'C' Characteristics

'C' characteristics MCBs are used for protection of electrical circuits in general and are most widely used because of its suitability for practically all electrical circuits, cable and line protection. They are capable of supplying the majority of inductive and capacitive loads including most motor and fluorescent lighting loads.

This characteristic allows applying loads having high peak currents without requiring the MCB to be oversized. In fact, thanks to this characteristic, it is possible to apply loads with peak currents up to 5 times I_n , (rated current) and can

hence be used to best advantage for handling higher inrush currents e.g. lamps, motors, etc. Under 'C' characteristics, the magnetic operating limits (for short-circuit operations) are between 5 and 10 times the rated current (I_n) of MCB. For example the instantaneous mechanism of a 10A MCB will operate between 50A and 100A in an overcurrent situation. The thermal operating limits (for overload operation) are between 1.13 and 1.45 of the rated current (I_n) of the MCB.

Number	1	2 ... 3	4 ... 6	> 7
Correction factor K	1.00	0.90	0.88	0.85

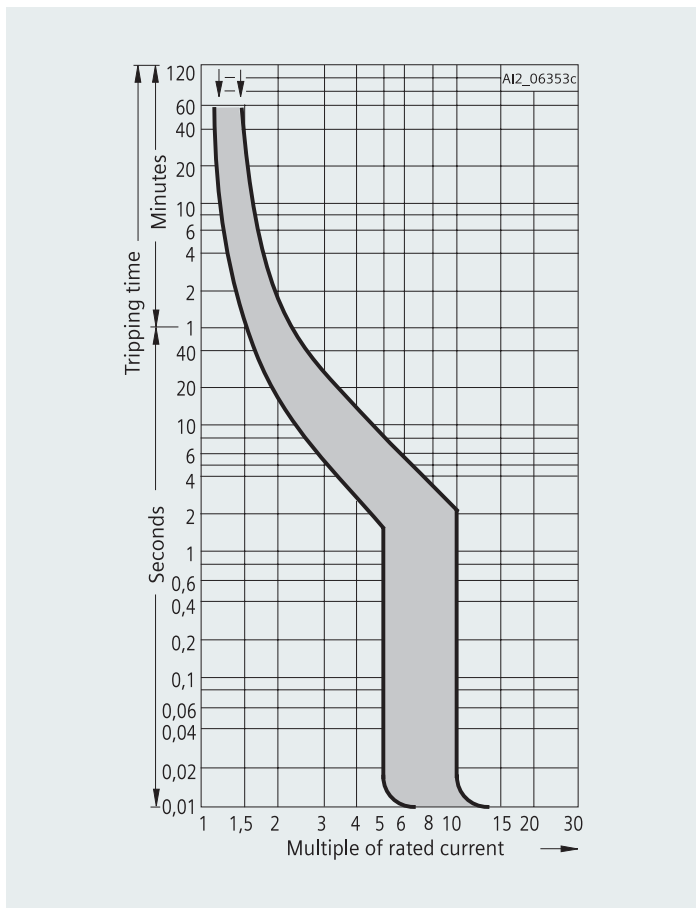

Tripping Characteristics : C

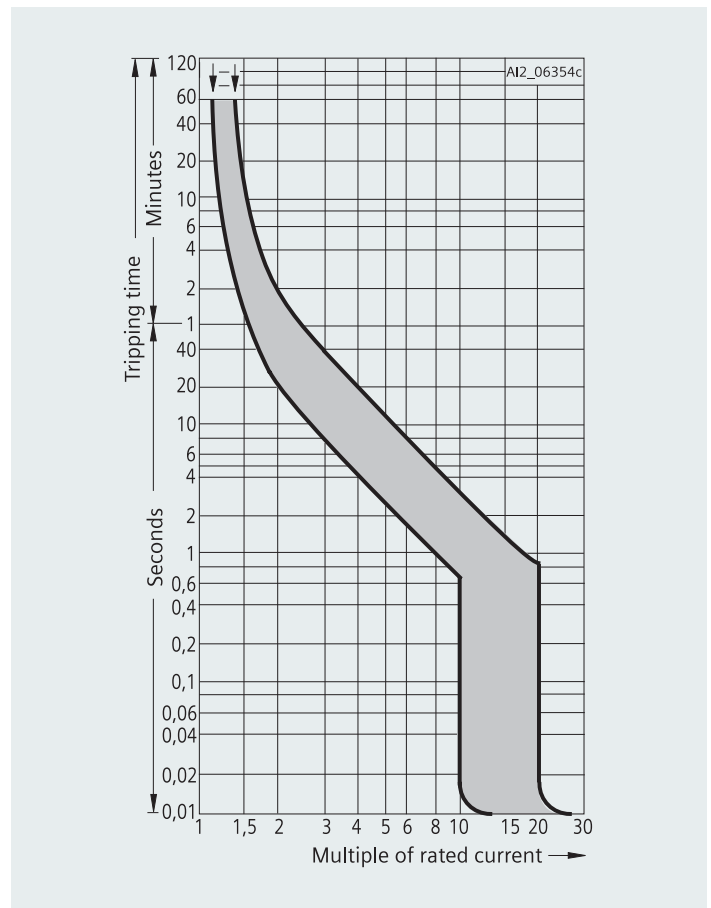

Tripping Characteristics : D

Betagard Miniature Circuit Breakers & Betagard DC Circuit Breakers

Overview

Effect of Higher Operating Voltages

Betagard MCB is designed to operate at 240/415V, 50Hz. However the device can operate at 480V, 50Hz with a reduction in breaking capacity of 50%.

DC Operation

Single pole MCBs can be used up to 60V DC and double pole up to 110V DC.

However, they should not be used below 18V DC. Though the thermal operation is delayed but this is negligible. The instantaneous tripping characteristic must be increased by 40% (e.g. a Type 'C' MCB has a magnetic tripping characteristic between 5 and 10 times the rated current. This magnetic tripping characteristic would therefore become between 7 and 14 times the rated current.

Frequency Variation

MCBs may be used up to their normal voltage rating on 400Hz supplies; however the magnetic tripping characteristic must be increased by 30% (e.g. Type 'C' MCB with magnetic characteristics between 5 and 10 times the rated current would become between 6.5 and 13 times rated current.

Effect of temperature on tripping characteristics :

Betagard MCBs are designed to meet the requirements of IS 8828 / IEC 60898 for tripping performance at ambient temperature 30°C. At other operating temperature the overload tripping band is modified by approximately 5% per 10° kelvin temperature difference, which increases for lower and decreases for higher temperatures than 30°C.

"D" Characteristics

D characteristics MCBs are used for protection of electrical circuits involving significant inrush currents like solenoid valves, capacitor banks, transformers, etc.

The main use of D characteristics MCBs is to ensure correct sizing of the device wherein high inrush currents are prevailing.

This characteristics allows to use in a high inrush current circuits without requiring the MCB to be oversized.

D characteristics MCB shall take the inrush current with peak up to 10 times I_n , (Rated current) and can be used best advantage for handling much higher inrush currents eg: Switching solenoids/capacitor banks/transformers etc.

Under D characteristics, the magnetic operating limits (for short circuit operations) are between 10 to 20 times the rated current of MCB.

For example the instantaneous mechanism of 10A MCB will operate between 100A and 200A in an over current situation.

Selectivity of miniature circuit-breakers/fuses

Generally, distribution networks are configured as radial

networks. An overcurrent device must be provided at each reduction of the conductor cross section. This results in a cascade graded according to the rated current, which should, where possible, provide selectivity.

Selectivity means, that in the event of a fault, only the protective device in the vicinity of the fault trips. Thus, parallel current paths can continue to provide the necessary power.

For MCBs with upstream fuses, the selectivity limit essentially depends on the current limits and tripping characteristics of the MCB as well as on the pre-arcing I^2t value of the fuse. Therefore, MCBs with different characteristics and rated breaking capacities also have different selectivity limits. The subsequent tables show the currents up to which selectivity is provided between MCBs and upstream fuses according to DIN VDE 0636 Part 21. The values specified in kA are limit values which have been determined under unfavourable test conditions. In practice, better values can be obtained, depending on the type of the upstream fuse.

In the event of a short circuit, when using the 5SX4, MCBs and fuses according to DIN VDE 0636 Part 21, Selectivity is provided up to the indicated values in kA.

Miniature Circuit Breakers (MCBs) : Type 5SP4

General

Siemens Betagard range of MCBs type 5SP4 offer high short circuit breaking capacity equal to 10kA as per IEC 60898 / IS 8828. These MCBs have excellent current limiting and selectivity characteristics. MCBs are available with C as well D tripping characteristics with current range of 80A - 125A and 80A - 100A respectively.

Features at a glance

- Current limiting class 3 MCBs
- Finger touch proof terminals (FTPT)
- Trip free mechanism
- Suitable for AC/DC circuits
- DIN rail and screw mounting possible
- Accessories like auxiliary contact, shunt trip, undervoltage release, fault signal contact

Applications

- Mainly as an incomer MCB in residential, industrial and commercial applications
- C characteristics MCBs suitable for general line protection especially with higher starting current lamps, motors etc.
- D characteristics MCBs suitable for high inrush current applications line transformers generating significant pulses, solenoid valves etc.

Betagard DC Circuit Breakers : Type 5SX5, 5SJ5

In alternating current circuits, arc quenching is assisted by the fact that current passes through zero, and that the current can only continue to flow if the arc is re-stuck across the open contacts during the following half wave. Direct current does not provide such assistance. In this case, a high arc voltage must be developed in order to stop the flow of the DC current.

Therefore, the DC switching capacity depends on the arc quenching method employed by the switching device, on the network voltage & on the inductive reactance of the circuit.

In order to address DC network protection, Siemens offers 5SX5 / 5SJ5 series DC circuit breakers from 0.5A to 63A in Single pole & Double pole version.

When using DC CBs in DC networks, care must be taken to ensure the contact polarity of the connections.

In trains fed by a DC voltages (metros & railways) there is a wide range of L/R (Time Constants) values and over current levels. Consequently such special application requires fully enclosed operations.

For such application 5SX5 / 5SJ5 is the right choice for load up to 63 Amps to ensure people safety

Features

- Compact in size and hence reduction in panel size.
- Total recessed dial avoids accidental switching due to human negligence.
- Suitable for breaking capacity up to 10 kA
- Accessories like Aux block, fault signal contacts can be retro fitted at site.
- Finger touch proof (FTPT) ensures total safety for operator.

CBs for DC and AC/DC Applications

In DC networks up to 110 V , existing 5SX4 MCBs are suitable for single-pole and double-pole application.

For higher voltages, the versions 5SX5/5SJ5 are required. Contrary to the other product range, the arcing chamber area of 5SX5 / 5SJ5 is equipped with an additional permanent magnet to support the positive quenching of the arc.

For this reason, the polarity of the DC circuit breaker is clearly marked and must be observed when connecting the cables and conductors.

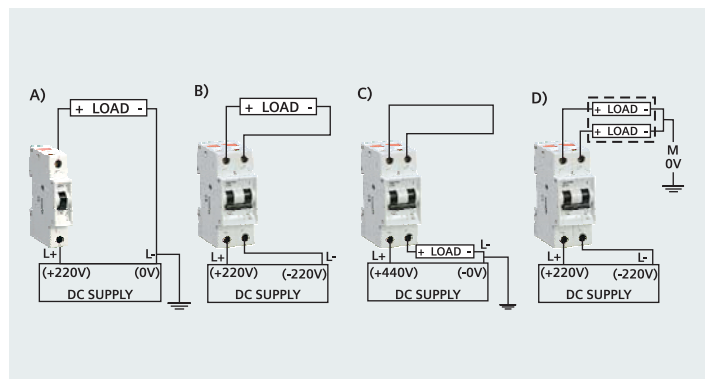
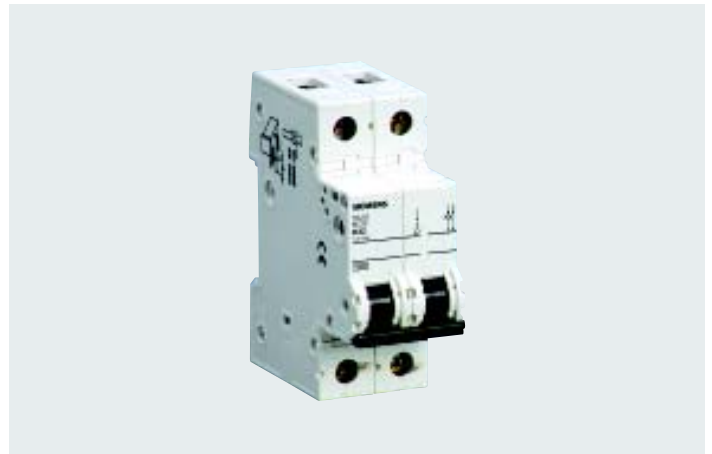

Betagard Miniature Circuit Breakers & Betagard DC Circuit Breakers

Technical data

Technical Data – 5SX4 MCBs

Standards	IS 60898 Part I : 2002		
Series	5SX4 / 5SJ4		
Tripping characteristics	'C' / 'D'		
No. of poles	SP, DP, TP, FP		
Rated voltage	Volts	240 / 415 V AC, 50/60 Hz	
		SP – 60V DC, DP – 110V DC	
Current Range	Amps	0.5 – 63	
Operational voltage	min. AC/DC V	24	
	max. DC V/Pole	60	
	max. AC V	440	
Rated Breaking Capacity			
acc. to IS 8828 / IEC 60898, DIN VDE 0641	AC	kA	10
Insulation coordination			
Rated insulation voltage	250/440 V AC		
Degree of pollution for overvoltage category III	2		
Mounting	on a 35 mm mounting rail (EN 50 022)		
Conductor cross sections			
Solid and stranded, max.			
Upper terminal	mm ²	16	
Lower terminal	mm ²	25	
Finely stranded with end sleeves, max.			
Upper terminal	mm ²	16	
Lower terminal	mm ²	25	
Terminal tightening torque			
(power driver setting)	Nm	2.5 - 3	
Supply connection	As required, top or bottom.		
Mounting position	As required in any position.		
Endurance	On an average 20,000 operations at rated load		
Ambient temperature	°C	-25 to +45, occasionally +55 max. 95% humidity, Storage temperature : -40 to +75	
Resistance to climate	According to IEC 68-2-30, 6 cycles		
Resistance to vibration	m/s ²	60 at 10 to 150 Hz according to IEC 68-2-6	

Technical Data – 5SP4 MCBs

Standards	IS 60898 Part I : 2002	
Series	5SP4	
Tripping characteristics	C	D
Current range	80A, 100A and 125A	80A and 100A
Rated voltage	240/415V AC and 60V DC/pole	
Operational voltage (max)	250/440V AC and 60V DC/pole	
Poles	SP, DP, TP, FP	
Rated breaking capacity	AC 10kA (as per IS 8828 / IEC 60898)	
	AC 20kA* (as per IS 13947 / IEC 60947)	
Depth	70mm	
Terminal tightening torque	3 to 3.5Nm	
Conductor cross sections	Solid and stranded	
	Fine stranded with end sleeves	
Supply connection	As required, top or bottom Polarity to be observed for DC applications	
Ambient temperature	-25°C to +45°C occasionally +55°C, max. 95% humidity, storage temp. -40°C to +75°C	
Service life	Average 20,000 operation at rated load	

* 15kA for 80A, 100A in 'D' characteristics

Tripping characteristics

Tripping characteristic	Thermal releases Test currents:			Electromagnetic releases Test currents:		
	limiting no-damage current I_1	minimum no-damage current I_2	tripping time $I_n > 63 A$	hold I_4	latest tripping instant I_5	tripping time t
C	$1.13 \times I_n$	$1.45 \times I_n$	> 2 h < 2 h	$5 \times I_n$	$10 \times I_n$	$\geq 0.1 s$ < 0.1 s
D	$1.13 \times I_n$	$1.45 \times I_n$	> 2 h < 2 h	$10 \times I_n$	$20 \times I_n$	$\geq 0.1 s$ < 0.1 s

Betagard Miniature Circuit Breakers & Betagard DC Circuit Breakers

Technical data

Technical Data – 5SX5, 5SJ5 DCCBs

Series	5SX5, 5SJ5
Current Range	0.5 ... 63 A
Rated voltage	220 V DC, 1P and 440 V DC, 2P
Poles	1P, 2P
Rated breaking capacity	10 kA (as per IS 60947 / IEC 60947)
Terminal lighting torque	3 to 3.5 Nm
Conductor cross-sections	
Solid and stranded	0.75 - 50 mm ²
Fine stranded with end sleeves	0.75 - 35 mm ²
Supply connection	Polarity to be observed (Refer connection diagram)
Ambient temperature	-25°C to +45°C occasionally +55°C, max. 95% humidity, storage temp. -40°C to +75°C

Betagard Miniature Circuit Breakers - 5SX4, 10kA with C characteristics

Un: 240/415V, 50...60Hz can be used in systems upto 60Vdc, 1P and 110Vdc, 2P





Breaking capacity: 10kA as per IS 60898 part I : 2002; Icu=15kA as per IS 60947-2 upto 32A

With ISI marking: CM/L No. 2255548

IS 60898



CM/L No. 2255548

		Rated current I_n (A)	MW [#]	Reference No.	Std. Pkg. (Nos.)
	1-pole	0.5	1	5SX41057RC	1/20
		1		5SX41017RC	1/20
		2		5SX41027RC	1/20
		4		5SX41047RC	1/20
		6		■ 5SX41067RC	1/20
		10		■ 5SX41107RC	1/20
		16		■ 5SX41167RC	1/20
		20		■ 5SX41207RC	1/20
		25		■ 5SX41257RC	1/20
		32		■ 5SX41327RC	1/20
		40		5SX41407RC	1/20
		50		5SX41507RC	1/20
		63		5SX41637RC	1/20
	2-pole	0.5	2	5SX42057RC	1/10
		1		5SX42017RC	1/10
		2		5SX42027RC	1/10
		4		5SX42047RC	1/10
		6		5SX42067RC	1/10
		10		5SX42107RC	1/10
		16		5SX42167RC	1/10
		20		5SX42207RC	1/10
		25		5SX42257RC	1/10
		32		■ 5SX42327RC	1/10
		40		5SX42407RC	1/10
		50		5SX42507RC	1/10
		63		■ 5SX42637RC	1/10
	3-pole	0.5	3	5SX43057RC	1/10
		1		5SX43017RC	1/10
		2		5SX43027RC	1/10
		4		5SX43047RC	1/10
		6		5SX43067RC	1/10
		10		5SX43107RC	1/10
		16		5SX43167RC	1/10
		20		5SX43207RC	1/10
		25		5SX43257RC	1/10
		32		■ 5SX43327RC	1/10
		40		■ 5SX43407RC	1/10
		50		5SX43507RC	1/10
		63		■ 5SX43637RC	1/10
	4-pole	0.5	4	5SX44057RC	1/10
		1		5SX44017RC	1/10
		2		5SX44027RC	1/10
		4		5SX44047RC	1/10
		6		5SX44067RC	1/10
		10		5SX44107RC	1/10
		16		5SX44167RC	1/10
		20		5SX44207RC	1/10
		25		5SX44257RC	1/10
		32		■ 5SX44327RC	1/10
		40		■ 5SX44407RC	1/10
		50		5SX44507RC	1/10
		63		5SX44637RC	1/10

Note: ■ Stock Items • # 1MW (Module Width) = 18mm

Betagard Miniature Circuit Breakers & Betagard DC Circuit Breakers

Selection & ordering data

Betagard Miniature Circuit Breakers - 5SX4/5SJ4, 10kA with D characteristics

Un: 240/415V, 50...60Hz can be used in systems upto 60Vdc, 1P and 110Vdc, 2P

Standards: IS 60898, IEC 60898





Breaking capacity: 10kA as per IS 60898 part I : 2002

With ISI marking: CM/L No. 2255548

IS 60898



CM/L No. 2255548

		Rated current I_n (A)	MW#	Reference No.	Std. Pkg. (Nos.)
	1-pole	0.5	1	5SX41058RC	1/20
		1		5SX41018RC	1/20
		2		5SX41028RC	1/20
		4		5SX41048RC	1/20
		6		■ 5SX41068RC	1/20
		10		■ 5SX41108RC	1/20
		16		■ 5SX41168RC	1/20
		20		5SX41208RC	1/20
		25		5SX41258RC	1/20
		32		5SX41328RC	1/20
		40		5SJ41408RC	1/20
		50		5SJ41508RC	1/20
		63		5SJ41638RC	1/20
				2-pole	0.5
1	5SX42018RC		1/10		
2	5SX42028RC		1/10		
4	5SX42048RC		1/10		
6	5SX42068RC		1/10		
10	5SX42108RC		1/10		
16	5SX42168RC		1/10		
20	5SX42208RC		1/10		
25	5SX42258RC		1/10		
32	■ 5SX42328RC		1/10		
40	5SJ42408RC		1/10		
50	5SJ42508RC		1/10		
63	■ 5SJ42638RC		1/10		
	3-pole		0.5		3
		1	5SX43018RC	1/10	
		2	5SX43028RC	1/10	
		4	5SX43048RC	1/10	
		6	5SX43068RC	1/10	
		10	5SX43108RC	1/10	
		16	5SX43168RC	1/10	
		20	5SX43208RC	1/10	
		25	5SX43258RC	1/10	
		32	■ 5SX43328RC	1/10	
		40	■ 5SJ43408RC	1/10	
		50	5SJ43508RC	1/10	
		63	■ 5SJ43638RC	1/10	
			4 pole	0.5	
1	5SX44018RC			1/10	
2	5SX44028RC			1/10	
4	5SX44048RC			1/10	
6	5SX44068RC			1/10	
10	5SX44108RC			1/10	
16	5SX44168RC			1/10	
20	5SX44208RC			1/10	
25	5SX44258RC			1/10	
32	■ 5SX44328RC			1/10	
40	■ 5SJ44408RC			1/10	
50	5SJ44508RC			1/10	
63	■ 5SJ44638RC			1/10	

Note:

■ Stock Items

1MW (Module Width) = 18mm

Betagard Miniature Circuit Breakers, LS125 - 5SP4, 10kA MCBs with C/D characteristics

Un: 240/415V, 50...60Hz can be used in systems upto 60Vdc, 1P and 110Vdc, 2P

Standards: IS 60898, IEC 60898

Breaking capacity: 10kA as per IS 60898; Icu=20kA as per IS 60947-2





With ISI marking : CM/L No. 2255548

IS 60898







CM/L No. 2255548

C characteristic

		Rated current I_n (A)	MW#	Reference No.	Std. Pkg. (Nos.)
	1-pole	80	1.5	5SP41807RC 5SP41917RC 5SP41927RC	1/10
		100			1/10
		125			1/10
	2-pole	80	3	■ 5SP42807RC ■ 5SP42917RC 5SP42927RC	1/5
		100			1/5
		125			1/5
	3-pole	80	4.5	5SP43807RC ■ 5SP43917RC ■ 5SP43927RC	1
		100			1
		125			1
	4-pole	80	6	5SP44807RC ■ 5SP44917RC ■ 5SP44927RC	1
		100			1
		125			1

D characteristic

	1-pole	80	1.5	5SP41808RC 5SP41918RC	1/10
		100			1/10
	2-pole	80	3	5SP42808RC 5SP42918RC	1/5
		100			1/5
	3-pole	80	4.5	5SP43808RC 5SP43918RC	1
		100			1
	4-pole	80	6	5SP44808RC 5SP44918RC	1
		100			1

Note:

■ Stock Items

1MW (Module Width) = 18mm

Betagard Miniature Circuit Breakers & Betagard DC Circuit Breakers



Selection & ordering data

Betagard DC Circuit Breakers - 5SX5/5SJ5, 10kA DC Circuit Breakers

Un: 220Vdc/1P & 440Vdc/2P

Standards: IS 13947-2, IEC 60947-2

Breaking capacity: 10kA as per IS 13947-2

		Rated current I_n (A)	MW#	Reference No.	Std. Pkg. (Nos.)
	1-pole	0.5	1	5SX51057RC	1/20
		1		5SX51017RC	1/20
		2		5SX51027RC	1/20
		4		5SX51047RC	1/20
		6		5SX51067RC	1/20
		10		5SX51107RC	1/20
		16		5SX51167RC	1/20
		20		5SX51207RC	1/20
		25		5SX51257RC	1/20
		32		5SX51327RC	1/20
		40		5SJ51407RC	1/20
		50		5SJ51507RC	1/20
		63		5SJ51637RC	1/20
				2-pole	0.5
1	5SX52017RC		1/10		
2	5SX52027RC		1/10		
4	5SX52047RC		1/10		
6	5SX52067RC		1/10		
10	5SX52107RC		1/10		
16	5SX52167RC		1/10		
20	5SX52207RC		1/10		
25	5SX52257RC		1/10		
32	5SX52327RC		1/10		
40	5SJ52407RC		1/10		
50	5SJ52507RC		1/10		
63	5SJ52637RC		1/10		

Note:
1MW (Module Width) = 18mm



Additional components

Betagard MCBs 5SX4 & DC circuit breakers 5SX5

For applications in industry and in system and plant engineering, add-on accessories are available, such as auxiliary contacts (AC), fault-signal contacts (FC), shunt trips (ST). ST is mounted left of MCB. AC/FC are mounted on right side. These modules can be used as inputs/outputs to a PLC, building-automation system etc. for signalling and control.

Auxiliary contacts (AC)

Each block consists of two electrically independent contacts (separated electrical circuits); one of these contacts is normally open and the other normally closed. The mechanically stable position of the contacts does not change unless the circuit-breaker is manually actuated or is tripped due to an overload or a short circuit. The terminals are characterised by a degree of protection IP 2X; they allow connecting conductors with a maximum cross-

section of 2.5 mm² and are delivered with combined slotted and podzidrive head screws.

Fault signal contacts (FC)

The fault signal contact block has a structure and dimensions identical to those of the auxiliary contact block (AC). The fault signal contact block remotely indicates the tripping of device due to an overload or a short-circuit. The block's contact remain in position when the circuit-breaker's handle is manually actuated.

Shunt trip (ST)

The shunt trip coil allows the circuit breaker to be remotely tripped. The coil and circuit breaker are coupled together not only by using the control handle, but also with the internal trigger.

Auxiliary contact (AC)

AC	Type Ref (5SX4)	Type Ref (5SJ4)
1NO+1NC	5SX9100	5ST3010
2NO	5SX9101	–



Applications : Remotely indicating the switching condition of the MCB ON/OFF

- Can be subsequently mounted to the MCB.
- Mounted using factory installed clips.
- Max. contact load :
6A, 230 V AC, AC-15
1 A, 220 V DC, DC-13
- Cable size upto
1 x 2.5 sq mm to be used.

Fault signal contact

FC	Type Ref (5SX4)	Type Ref (5SJ4)
1NO+1NC	5SX9200	5ST3020



Applications : Remotely indicating the tripping condition of the MCB

- Can be subsequently mounted to the MCB.
- Mounted using factory installed clips.
- Max. contact load :
6A, 230 V AC, AC-15
1 A, 220 V DC, DC-13
- Cable size upto
1 x 2.5 sq mm to be used.

Shunt trip (ST)

Shunt Release	Type Ref (5SX4)	Type Ref (5SJ4)
110...415VAC	5SX9300	5ST3030
24...48VDC	–	5ST3031



Applications : Remotely tripping the MCB. 100% switch-on duration.

- Mounted using attached screws.
- Can be used for voltages 110 to 415 V AC, Short-circuit protection using MCB.

Maximum possible configurations for accessories

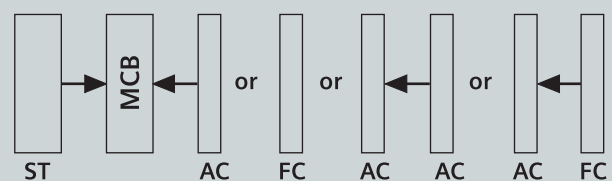

Additional components

Auxiliary circuit switch/fault signal contact for 5SJ and 5SP4

Benefits

- Can be retrofitted individually (for mounting concept, refer to page 2/7)
- Can be connected to *instabus* KNX EIB and AS-Interface bus over binary inputs

Application



Indication of the miniature circuit-breaker's switching state:

- AS: ON/OFF
- FC: tripped

Design

- Min contact load: 50 mA, 24 V

Selection and ordering data

	Version	MW	Order No.	Weights 1 item kg	PS*/ P unit Items	
	Auxiliary circuit switches (AS)  for small output	1 NO + 1 NC	0.5	5ST3 010	0.050	10
	Fault signal contacts (FC) 	1NO + 1 NC	0.5	5ST3 020	0.050	10

Remote controlled mechanism (RC)

Function / Applications:

- ON/OFF remote control switch of MCB
- Remote switching ON is possible following acknowledgment of fault occurrence
- Manual switching on-site possible
- Remote display of switching status of remote controlled mechanism and MCB



Rated voltage U_n	MW [#]	Type ref. no.
230V AC	3.5	5ST3 050

Mounting concept (possible configurations)

Mounting concept

Using this mounting concept, all additional 5ST3 components can be combined with miniature circuit-breaker of 5SP4 series:

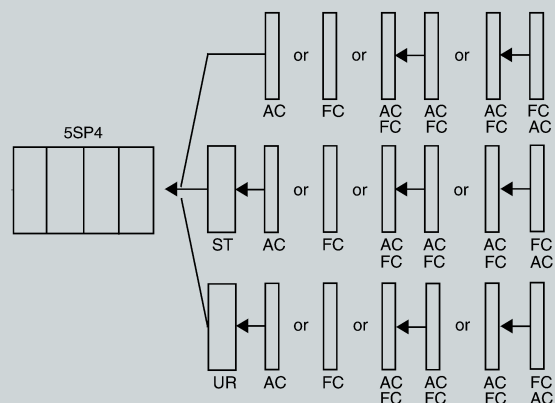

1 Module Width (MW) = 18mm

Additional components

Shunt trip/undervoltage release for 5SJ and 5SP4

Benefits

Shunt release

- Can be retrofitted individually (for mounting concept, refer to page 2/7)
- Suitable for voltages: 110 to 415 V AC, 110 V AC
24 to 48 V AC/DC
- Can be connected to *instabus* KNX EIB and AS-Interface bus through binary outputs

Undervoltage releases

- Can be retrofitted individually (for mounting concept, refer to page 2/7)
- Suitable for voltages: 230 V AC
110 V DC
24 V DC

- Can be connected to *instabus* KNX EIB and AS-Interface bus through binary outputs

Application



Shunt release

- Remove tripping of the miniature circuit-breaker

Undervoltage releases

- Applicable as remote trip in an EMERGENCY-OFF loop
- Ensures disconnection of the control circuit acc. to EN 60204
- In cases of interrupted or insufficient voltage, the undervoltage release trips the miniature circuit-breaker or prevents it from switching on.

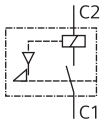
Selection and ordering data

	Rated voltage U_n	MW	Order No.	Weight 1 item kg	PS*/ P unit Items
	Shunt trips (ST)				
		110 ... 415 V AC 24 ... 48 V AC/DC	1 1	5ST3 030 5ST3 031	0.098 0.098
	Undervoltage releases (UR)				
		230 V AC 24 V DC	1	5ST3 043 5ST3 045	0.115 0.115

Rotary Handle Assembly for MCB s (ROH)

Benefits

- 5SJ, 5SY, 5SL, 5SP and 5TE8 series of MCBs/ Isolators can be fitted with Betagard Rotary Handle Assembly (ROH) for installation in Switchgear Cubicles and Distribution Panels
- The ROH gives operating uniformity and improves the aesthetics of the panel.
- The ROH can be padlocked in OFF position with the help of suitable padlocks thereby ensuring complete safety to operating personal during maintenance.
- Door interlock and defeat facility is available as a standard feature.

Applications

- Panel Boards / Switch Boards

Technical Details:

Product	Order No	Weight 1 item Kg	PS*/ P unit Items
 Rotary Handle Assembly for MCB	5ST38140RC	0.584	1

Betagard Miniature Circuit Breakers & Betagard DC Circuit Breakers

Dimensions

Betagard MCBs 5SX4 & DC circuit breakers 5SX5

SP

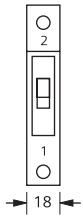

MW = 1

1MW = 18mm

DP

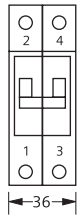

MW = 2

TP

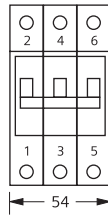

MW = 3

FP

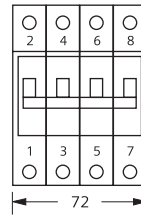

MW = 4

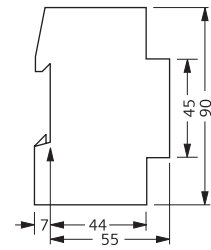

Betagard MCBs 5SJ4 & DC circuit breakers 5SJ5

SP

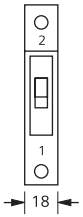

MW = 1

1MW = 18mm

DP

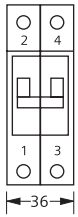

MW = 2

TP

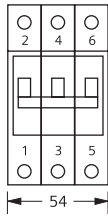

MW = 3

FP

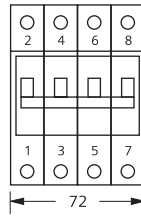

MW = 4

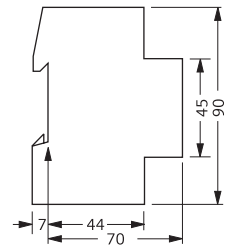

Betagard MCBs 5SP4

SP

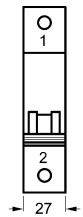

MW = 1

1MW = 18mm

DP

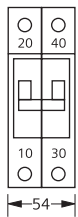

MW = 2

TP

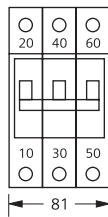

MW = 3

FP

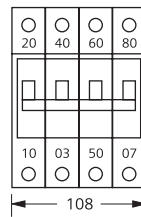

MW = 4

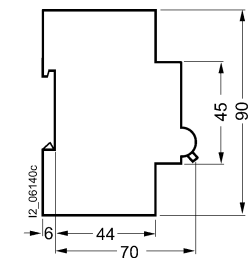

All dimensions in mm

Betagard Residual Current Breaker Operator

2



**Assured safety for
your loved ones**

2/2	Overview
2/3	Technical specifications
2/4	Product overview
2/6	Additional components
2/8	Dimensions



Overview

The resistance of a human body to current depends on the current path. Measurements have shown that, a current path of hand/hand or hand/foot has a resistance of approx. 1000Ω , taking into account a fault voltage of 230V AC, this produces a current of 230mA for the current path hand/hand.

Three function groups largely determine the setup of residual current protective devices:

- a. Summation current transformers for fault current detection
- b. Releases to convert the electrical measured quantities into a mechanical tripping operation
- c. Breaker mechanism with contacts

The summation current transformer covers all conductors required to conduct the current, i.e. also the neutral conductor where applicable.

In a fault free system, the magnetizing effects of the conductors through which current is flowing cancel each other out for the summation current transformer, as the sum of all currents is zero. There is no residual magnetic field left that could induce a voltage in the secondary winding. However, by contrast, if a residual current is flowing due to an isolation fault, this destroys the equilibrium and a residual magnetic field is left in the core of the converter. This generates a voltage in the secondary winding, which then uses the release and the breaker mechanism to switch off the electrical circuit afflicted with the isolation fault. This tripping principle operates independently of the system voltage or an auxiliary power supply. This way it can be ensured that the full protective action of the residual current protective device is maintained even in the event of a system fault.

Due to the use of electronic components in household appliances and industrial plants, insulation faults can also cause residual currents that are not AC residual currents to flow through residual current protective devices, even in the case of devices with ground terminals.

The basic prerequisite for use of a residual current protective device is the running of a grounded PE conductor to the components and equipment to be protected. A current flow can then pass through a human body only when two faults occur (1) Interruption of the PE conductor in addition to the insulation fault or (2) When there is unintentional contact with live parts.

Residual current protective devices offer protection against

1. Direct contact – Direct contact is considered as direct contact of a human body with a live part.
2. Indirect contact (fault protection) – Indirect contact is considered as the contact of a human body with a de-energized, electrically conductive part. In these cases,

the demand is for automatic interruption of the power supply when a fault can pose a risk due to the intensity and duration of the touch voltage.

3. Fire protection – For locations exposed to fire hazards, residual current protective devices should offer earth leakage protection for the prevention of fires, which may originate from insulation faults.

Types of residual current protective devices

1. Type AC – Residual current protective devices of type AC are suitable only for detecting sinusoidal AC residual currents.
2. Type A – In addition to AC sinusoidal currents, residual current protective devices of type A also measure pulsating DC residual currents. e.g. applications like ECGs, washing machines, fax machines etc. having electronic components.

Betagard RCBOs have the unique distinction of combining the earth leakage protection function of an RCCB with the overload and short circuit function of MCB.

Betagard RCBO (2P, 2M) is available from 6 to 40A in 1Pole+Neutral version. The device has a breaking capacity of 10kA as per IEC60898 and is available in 2 Module width size.

This RCBO can be used for personnel as well as fire protection:

- $I\Delta n \leq 30\text{mA}$: Additional protection in the case of direct contact
- $I\Delta n \leq 300\text{mA}$: Preventive fire protection in the case of ground fault currents

Betagard RCBOs are also offered combination devices, which offer overcurrent protection for overload and short circuit protection in addition to protection against residual currents. A version in this device group is a residual current block (RC unit) combined to a miniature circuit breaker (selected on the basis of characteristic & rated current) to form a RCBO. These devices are factory assembled and offer the same functions as RCBO. The RC unit has no contacts of its own; in the event of a fault, it trips the circuit breaker, which opens the contacts and interrupts the circuit.

Betagard RCBOs are available in 4 standard versions from 32A to 63A. They offer 10kA-breaking capacity as per IS8828 in 2P and 4P versions.

1. MCB C characteristics with RC unit Type AC
2. MCB C characteristics with RC unit Type A
3. MCB D characteristics with RC unit Type AC
4. MCB D characteristics with RC unit Type A

Technical specifications (5SU1 RCBOs)

Standards	IS 12640-2 (2008), IEC 61009, VDE 0664 Part 20/Part 30, IEC 61543
Poles	1Pole + N, 2P, 4P
Rated voltages, U_n (V)	125...240V AC, 50...60Hz; 240V / 415 V AC 50...60Hz
Rated currents, I_n (A)	6, 10, 16, 20, 25, 32, 40, 63
Rated residual currents (mA)	30, 100, 300
Rated short circuit capacity (kA)	10
Tripping characteristics	C, D
Energy limiting class	3
Enclosure	Gray molded plastic (RAL 7035)
Mounting depth (mm)	70
Terminals	
1. Conductor cross section (sqmm)	1... 25
2. Terminal tightening torque (Nm)	2.5.... 3
Supply connection	Either top or bottom
Mounting position	Any
Mounting technique	Can be snapped on to a 35mm DIN rail
Degree of protection	IP20 acc to EN60529 (VDE 0470 Part 1) IP40/IP42 for installation in distribution boards
Minimum operating voltage for test function operation (V)	195V AC
Device service life	> 10,000 operations (electrical and mechanical)
Storage temperature (°C)	-40.... +75
Ambient temperature (°C)	-25.... +45
CFC and silicon free	Yes

Betagard Residual Current Breaker Operator

Product overview

Betagard Residual Current Breaker Operators - 5SU1, 10kA

Un 240Vac, 50...60Hz

Product Standards: IS 12640, Part 2/IEC 61009-1

With ISI marking : CM/L No. 7676193

IS 12640 Part 2



CM/L No. 7676193



Type AC, applicable in networks for AC residual currents

	Rated residual current I_n (mA)	Rated current I_n (A)	MW [#]	Reference No.	Std. Pkg. (Nos.)	
	1 pole + N	30	6	2	5SU13541RC06	1/10
		30	10		5SU13541RC10	1/10
		30	16		5SU13541RC16	1/10
		30	20		5SU13541RC20	1/10
		30	25		■ 5SU13541RC25	1/10
		30	32		■ 5SU13541RC32	1/10
		30	40		■ 5SU13541RC40	1/10
		300	6		5SU16541RC06	1/10
		300	10		5SU16541RC10	1/10
		300	16		5SU16541RC16	1/10
		300	20		5SU16541RC20	1/10
		300	25		5SU16541RC25	1/10
		300	32		5SU16541RC32	1/10
		300	40		5SU16541RC40	1/10

Type A, applicable in networks with AC residual currents and/or pulsating DC currents

	1 pole + N	30	6	2	5SU13547RC06	1/10
		30	10		5SU13547RC10	1/10
		30	16		5SU13547RC16	1/10
		30	20		5SU13547RC20	1/10
		30	25		5SU13547RC25	1/10
		30	32		5SU13547RC32	1/10
		30	40		5SU13547RC40	1/10
		300	6		5SU16547RC06	1/10
		300	10		5SU16547RC10	1/10
		300	16		5SU16547RC16	1/10
		300	20		5SU16547RC20	1/10
		300	25		5SU16547RC25	1/10
		300	32		5SU16547RC32	1/10
		300	40		5SU16547RC40	1/10

Type AC with C characteristic

	Rated Residual Current $I_{\Delta n}$ (mA)	Rated Current I_n (A)	Module Width [#]	Reference No.	Std. Pkg. (Nos.)	
	240Vac; 50...60Hz; 2 pole	30	4	32	5SU13241RC32	1/10
				40	5SU13241RC40	1/10
				63	5SU13241RC63	1/10
		100	4	32	5SU14241RC32	1/10
				40	5SU14241RC40	1/10
				63	5SU14241RC63	1/10
		300	4	32	5SU16241RC32	1/10
				40	5SU16241RC40	1/10
				63	5SU16241RC63	1/10
	415Vac; 50...60Hz; 4 pole	30	7	32	5SU13441RC32	1/5
				40	5SU13441RC40	1/5
				63	5SU13441RC63	1/5
		100	7	32	5SU14441RC32	1/5
				40	5SU14441RC40	1/5
				63	5SU14441RC63	1/5
		300	7	32	5SU16441RC32	1/5
				40	5SU16441RC40	1/5
				63	5SU16441RC63	1/5



Note:

■ Stock Items



1MW (Module Width) = 18mm

Product overview



Type AC with D characteristic

	Rated Residual Current I _{Δn} (mA)	Rated Current I _n (A)	Module Width#	Reference No.	Std. Pkg. (Nos.)
	240Vac; 50...60Hz; 2 pole				
	30	32	4	5SU13242RC32	1/10
		40		5SU13242RC40	1/10
		63		5SU13242RC63	1/10
	100	32	4	5SU14242RC32	1/10
		40		5SU14242RC40	1/10
		63		5SU14242RC63	1/10
	300	32	4	5SU16242RC32	1/10
		40		5SU16242RC40	1/10
63		5SU16242RC63		1/10	
	415Vac; 50...60Hz; 4 pole				
	30	32	7	5SU13442RC32	1/5
		40		5SU13442RC40	1/5
		63		5SU13442RC63	1/5
	100	32	7	5SU14442RC32	1/5
		40		5SU14442RC40	1/5
		63		5SU14442RC63	1/5
	300	32	7	5SU16442RC32	1/5
		40		5SU16442RC40	1/5
		63		5SU16442RC63	1/5

Type A with C characteristic

	240Vac; 50...60Hz; 2 pole				
	30	32	4	5SU13247RC32	1/10
		40		5SU13247RC40	1/10
		63		5SU13247RC63	1/10
	100	32	4	5SU14247RC32	1/10
		40		5SU14247RC40	1/10
		63		5SU14247RC63	1/10
	300	32	4	5SU16247RC32	1/10
		40		5SU16247RC40	1/10
63		5SU16247RC63		1/10	
	415Vac; 50...60Hz; 4 pole				
	30	32	7	5SU13447RC32	1/5
		40		5SU13447RC40	1/5
		63		5SU13447RC63	1/5
	100	32	7	5SU14447RC32	1/5
		40		5SU14447RC40	1/5
		63		5SU14447RC63	1/5
	300	32	7	5SU16447RC32	1/5
		40		5SU16447RC40	1/5
		63		5SU16447RC63	1/5

Type A with D characteristic

	240Vac; 50...60Hz; 2 pole				
	30	32	4	5SU13248RC32	1/10
		40		5SU13248RC40	1/10
		63		5SU13248RC63	1/10
	100	32	4	5SU14248RC32	1/10
		40		5SU14248RC40	1/10
		63		5SU14248RC63	1/10
	300	32	4	5SU16248RC32	1/10
		40		5SU16248RC40	1/10
63		5SU16248RC63		1/10	
	415Vac; 50...60Hz; 4 pole				
	30	32	7	5SU13448RC32	1/5
		40		5SU13448RC40	1/5
		63		5SU13448RC63	1/5
	100	32	7	5SU14448RC32	1/5
		40		5SU14448RC40	1/5
		63		5SU14448RC63	1/5
	300	32	7	5SU16448RC32	1/5
		40		5SU16448RC40	1/5
		63		5SU16448RC63	1/5

1 module width = 18mm

Additional components

Auxiliary circuit switch/fault signal contact for 5SU1

Benefits

- Can be retrofitted individually (for mounting concept, refer to page 2/7)
- Can be connected to *instabus* KNX EIB and AS-Interface bus over binary inputs

Application



Indication of the miniature circuit-breaker's switching state:

- AS: ON/OFF
- FC: tripped

Design

- Min contact load: 50 mA, 24 V

Selection and ordering data

	Version	MW	Order No.	Weights 1 item kg	PS*/ P unit Items		
	Auxiliary circuit switches (AS) 	for small output	1 NO + 1NC	0.5	5ST3 010	0.050	10
	Fault signal contacts (FC) 		1NO + 1 NC	0.5	5ST3 020	0.050	10

Additional components

Shunt trip/undervoltage release for 5SU1

Benefits

Shunt release

- Can be retrofitted individually (for mounting concept, refer to page 2/7)
- Suitable for voltages:
110 to 415 V AC, 110 V AC
24 to 48 V AC/DC
- Can be connected to *instabus* KNX EIB and AS-Interface bus through binary outputs

Undervoltage releases

- Can be retrofitted individually (for mounting concept, refer to page 2/7)
- Suitable for voltages:
230 V AC
110 V DC
24 V DC

- Can be connected to *instabus* KNX EIB and AS-Interface bus through binary outputs

Application



Shunt release

- Remove tripping of the miniature circuit-breaker

Undervoltage releases

- Applicable as remote trip in an EMERGENCY-OFF loop
- Ensures disconnection of the control circuit acc. to EN 60204
- In cases of interrupted or insufficient voltage, the undervoltage release trips the miniature circuit-breaker or prevents it from switching on.

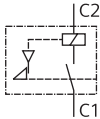
Selection and ordering data

		Rated voltage	MW	Order No.	Weight 1 item kg	PS*/ P unit Items
		U_n				
	<p>Shunt trips (ST)</p> 	110 ... 415 V AC	1	5ST3 030	0.098	1/5
		24 ... 48 V AC/DC	1	5ST3 031	0.098	1/5
	<p>Undervoltage releases (UR)</p> 	230 V AC	1	5ST3 043	0.115	1/5
		24 V DC		5ST3 045	0.115	1/5

Mounting concept

Using this mounting concept, all additional 5ST3 components can be combined with residual current breaker operators of 5SU1 series:

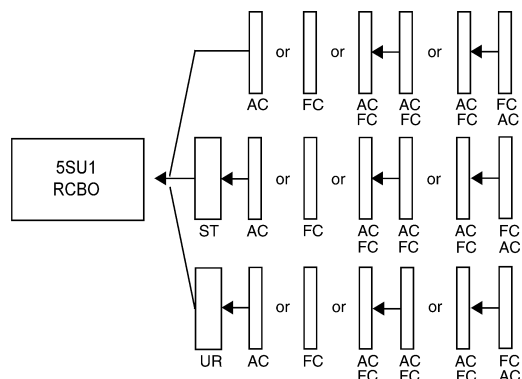

Betagard Residual Current Breaker Operator

Dimensions

2P-2M

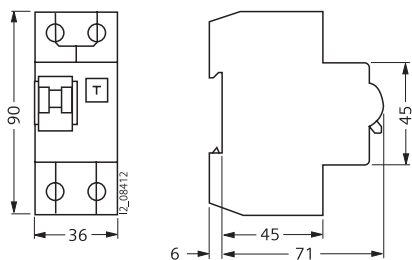

2P-4M

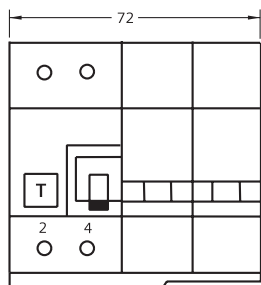

4P-7M

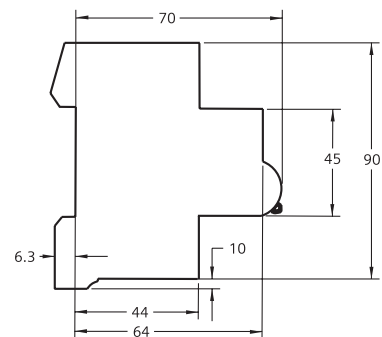
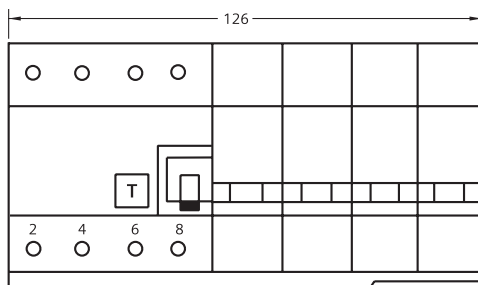

Add-on components

Auxiliary contact / Fault signal contact



Shunt trip / undervoltage release

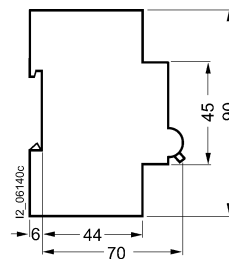
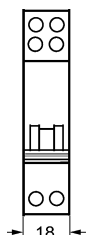

All dimensions in mm

Simply stylish



3/2	Design, construction and features
3/4	Selection and ordering data
3/7	Dimensions
3/17	Wiring instructions



Betagard metallic distribution board

A perfect blend of style and flexibility

Siemens Betagard distribution boards are suitable as sub-distribution boards in all domestic, commercial and industrial applications.

Owing to their small overall depth, they are used in both residential and commercial buildings and are usually installed in the vicinity of respective load centers.

They are connected down stream of the meter cabinet and the main or storey distribution board.

Equipment with a depth of 55 to 70 mm conforming to DIN rails (35mm X 7.5mm) conforming to DIN EN 50022 can be installed in the units.

In order to cater to various complex configuration in modern electric installation, we are glad to introduce following 5 new generation DBs. Flush as well as surface type distribution boards are available from 4 way to 12 ways in double door version.

- **Beta Flex DBs** are offered in row system and are available in 12 & 16 mod/row design. Presently these DBs are being offered in 2 Rows & 4 Rows configuration.
- **Beta Bus DBs** are designed with vertical readymade insulated bus bar and are available with 4W/6W/8W and 12WAY TP/SP configuration
- **Beta Bus Plus DBs** are also having special feature of accommodating siemens 3VT MCCB as I/C up to 160A apart from featured offered in Beta Bus
- **Beta Multi DBs** are having a special feature of accommodating TV socket and tel crone connector apart from LV power distribution.
- **Beta change over DBs** are designed to cater to few specific requirement of regions where-in the consistent availability 3 phase supplies are not reliable.

These DBs have provision of fixing 40/63A change over switch in order to shift the phase in the event of failure of any one phase in 3 phase network.

All above DBs are offered only in double door version with IP 42 protection.

Design:

Siemens Betagard distribution boards in sheet steel have been specially designed, keeping in view the interiors of modern day houses and commercial establishments.

Installation:

Betagard distribution boards are available both in flush as well as surface mounting versions.

These distribution boards are provided with removable top and bottom gland plates with adequate number of knock outs, enabling easy installation and connection of conduits of all sizes for top and bottom entry of cables.

Double door construction of DBs facilitates easy removal of inspection window mounted on intermediate plate.

A 15 deg correction factor is possible if the U plate of distribution boards is wrongly installed.

Construction:

Blending style, flexibility and safety, the betagard distribution boards are manufactured with high precision extra thick and fine quality CRCA steel sheet for long lasting strength.

These DBs undergo a seven tank phosphating process to ensure anti rust conditioning and superior finish.

Double door concept for aesthetic and safety:

To ensure total safety, an intermediate plate has been introduced so that when the door is opened, no live parts are exposed. The door is earthed through a copper braid for total safety.

- 1 Removable intermittent window for easy in maintenance / installation
- 2 Removable intermittent door ivory-white in colour to match any decor
- 3 Magnetic latch for firm door latching and comforts in opening and closing of DB doors
- 4 Vertical insulated busbar total safety and flexibility in mounting TP/SP MCBs

SIMBOX LC - IP 40

The small distribution board with big advantages: (100% Thermoplastic DB)

Residential distribution boards share typical property: They are usually installed at locations near to load and therefore near to people.

Due to the above fact it is obvious that they must offer

- Maximum safety by means of fire and corrosion resistance.
- Mechanical strength and increased shock hazard protection.

Safety requirements, for which our SIMBOX LC have consistently been tested and independently certified in compliance with EN 60439-3; IEC 60439-3

Design, construction and features

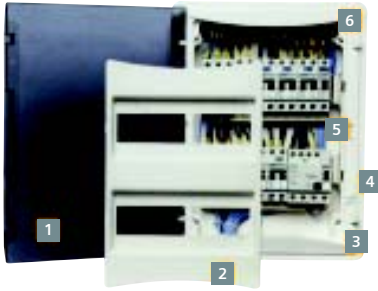

- 1 Transparent and removable DB door
- 2 Intermittent windows
- 3 Removable Intermittent Plate (IP)
- 4 Provision for cylindrical security lock
- 5 DIN Rail arrangements
- 6 Neutral link / Earthing termination

Features:

- A red-hot case for fire protection
In order to avoid fire damage caused by short circuits, we check our SIMBOX LC for their fire-resistant properties in the 'glow-wire test'
- Taking all the knocks
Mechanical strength is a further criterion to which we pay utmost attention. We therefore test our SIMBOX LC DBs for the danger of an electric shock following an impact load.
- Spotless reputation
As soon as live parts start to rust, safe operation can not be guaranteed. Therefore we also test the SIMBOX LC DBs for its resistance to corrosion. To do this, the test item is immersed in a solution of ammonium chloride, then stored for a specified period in a warm, damp atmosphere. The test is only passed if no traces of rust appear.
- We do not like the shocks and we believe in easy handling
The SIMBOX LC conforms to IP 40 degree of protection. This means that reliable level of shock hazard protection is guaranteed.
The unique design of Intermittent window cover enables electrician for easy access to components and wires without opening the IP cover and door while installation and maintenance.

Bring home installation benefits:

- The SIMBOX LC is designed by the top Italian designer Giorgio Giugiaro, who is one of the most celebrated designers of consumer and industrial products.
- The rail spacing of 150mm offers plenty of room for quick and easy wiring of the built in devices.
- The screw terminal offers sufficient clamping points for N and PE conductors.
- The DBs can subsequently be fitted with a lock.
- Facility available to hinge the door on the left or right hand side.
- The set of labels and symbols supplied permits tidy labeling of the respective circuits.

SIMBOX WP

Due to high degree of protection IP65, these small distribution boards can withstand harsh ambient conditions in both indoor and outdoor areas.

Their resistance to dust and splashing water makes them ideal for use in a range of different application areas, such as car washes, farms, joiners' workshops, etc.

Due to their large temperature operating range (-25°C to +60°C) UV radiation resistance and resistance to dust and splashing water, this distribution board range is especially suitable for harsh ambient conditions.

Design

Equipment

The distribution boards can be equipped with modular installation devices, such as MCBs and RCCBs with 63 A and a mounting depth of 55 mm up to 70 mm, by snapping onto the standard mounting rails 35 mm x 7.5 mm to EN 60715.

Depending on the selection, the small distribution boards can be equipped with devices of 12 to 18 modular widths.

Technical specifications

Rated current in A	Up to 63
Rated voltage in V AC	400
Degree of protection	IP65
Safety class	2 (total insulation)
Color	Light gray RAL 7035

Standards

The SIMBOX WP small distribution boards comply with EN 60439-3 and IEC 60439-3.

Versions

Tiers	MW per tier			
	4	8	12	18
1	✓	✓	✓	✓
2	–	–	✓	✓
3	–	–	–	✓
4	–	–	–	✓

Benefits

- The wiring space behind the standard mounting rail is 15 mm and 48 mm, ensuring fast and easy wiring.
- The extremely robust transparent door can also be equipped with a lock, which can be ordered from the range of accessories. The door can be hinged on the right or left without tools; its opening angle is 180°.
- The withdrawable equipment rack ensures easy and fast assembly. The generous wiring space and clearly arranged modular design reduce assembly times by approx. 20%.
- The plastic materials used can be recycled.

Betagard Distributions Boards

Selection and ordering data

Betagard Distribution Boards 8GB3/8GB1

	Item Description	Incoming Slots	Outgoing slots	Total slots	Reference No.	Std Pkg Nos.
Betaflex (Flexi DBs), IP42 :						
	2Row x 12Mod	—	—	24	8GB31424RC	1/5
	2Row x 16Mod	—	—	32	8GB31426RC	1/5
	4Row x 8Mod	—	—	32	■ 8GB31442RC	1/5
	4Row x 12Mod	—	—	48	■ 8GB31444RC	1/5
	4Row x 16Mod	—	—	64	8GB31446RC	1/5
Betabus (Vertical Busbar DBs with MCB as an incomer), IP42 : (Suitable for 5SX/5SJ/5SP MCBs, upto 125A as an incomer)						
	4 way	12	12	24	8GB31471RC	1/5
	6 way	12	18	30	8GB31473RC	1/5
	8 way	12	24	36	8GB31474RC	1/5
	12 way	12	36	48	8GB31477RC	1/5
Betabusplus (Vertical Busbar DBs with MCCB as an incomer), IP42 : (Suitable for 3VT1 MCCBs, upto 160A as an incomer)						
	4 way	12	12	24	■ 8GB31571RC	1/5
	6 way	12	18	30	■ 8GB31572RC	1/5
	8 way	12	24	36	■ 8GB31573RC	1/5
	12 way	12	36	48	8GB31574RC	1/5
BetaMulti (DBs for power & communication), IP42 :						
	12way SPN, provision	2	12	14	8GB31215RC	1/5
	6way TPN, provision	8	18	26	8GB31221RC	1/5
	12way SPN, built-in	2	12	14	8GB31315RC	1/5
	6way TPN, built-in	8	18	26	8GB31321RC	1/5
Beta CO (DBs for phase changeover), IP42 :						
	6 way, with provision	8	18	26	8GB31841RC	1/5
	8 way, with provision	8	24	32	8GB31842RC	1/5
	12 way, with provision	8	36	44	8GB31844RC	1/5

Note:

■ Stock Items

1MW (Module Width) = 18mm

For insulated shorting links for Betagard Distribution Boards, please refer page 8.

Selection and ordering data

Betagard Distribution Boards
8GB3/8GB1

	Item Description	Incoming Slots	Outgoing slots	Total slots	Reference No.	Std Pkg Nos.
Wire Way Boxes (WWB)						
	WWB for Flexi DB,8Mod	—	—	—	8GB9908FWWNT	1/5
	WWB for Flexi DB,12Mod	—	—	—	8GB9912FWWNT	1/5
	WWB for Flexi DB,16Mod	—	—	—	8GB9916FWWNT	1/5
	WWB for Bus DB	—	—	—	8GB99BUSWWNT	1/5
	WWB for Bus Plus DB	—	—	—	8GB99BPLUSWWNT	1/5
Modular Device Boxes (MDB)						
	MDB for Flexi DB, 8Mod/Row	—	—	8	8GB9908FMDTC	1/5
	MDB for Flexi DB,12Mod/Row	—	—	12	8GB9912FMDTC	1/5
	MDB for Flexi DB,16Mod/Row	—	—	16	8GB9916FMDTC	1/5
	MDB for Bus DB	—	—	12	8GB99BUSMBTC	1/5
	MDB for Bus Plus DB	—	—	12	8GB99BPLUSMBTC	1/5

3VT1 MCCB with thermal magnetic trip unit (overload and short circuit protection)
Breaking capacity, Icu = 25kA at 415V AC, 50Hz.
Standards: IS 13947-2 / IEC 60947-2
"with CE marking"

	Rated Current	3P Type Reference	4P Type Reference
	63A	3VT17062DA360AA0	3VT17062EA460AA0
	80A	3VT17082DA360AA0	3VT17082EA460AA0
	100A	3VT17102DA360AA0	3VT17102EA460AA0
	125A	3VT17122DA360AA0	3VT17122EA460AA0
	160A	3VT17162DA360AA0	3VT17162EA460AA0

	Item Description	Incoming slots	Outgoing slots	Total Slots	Reference No.	Std Pkg Nos.
Simbox WP (IP65 DBs)						
	1 Row, 4Mod	—	—	4	8GB13710	1
	1 Row 8Mod	—	—	8	8GB13711	1
	1 Row 12Mod	—	—	12	8GB13712	1
	1 Row 18Mod	—	—	18	8GB13713	1
	2 Row 2 x 12Mod	—	—	24	8GB13722	1
	2 Row, 2 x 18Mod	—	—	36	8GB13723	1
	3 Row, 3 x 18Mod	—	—	54	8GB13733	1
	4 Row 4 x 18Mod	—	—	72	8GB13743	1

Accessories for Simbox WP







	Coupling covers,12M				8GB20510	1
	Coupling covers,18M				8GB20511	1
	Insulated N/PE terminals, 8MW				8GB20520	1
	Insulated N/PE terminals, 12MW				8GB20521	1
	Insulated N/PE terminals, 18MW				8GB20522	1
	Cylindrical security lock				8GB20550	1
Interchangeable flange				8GB20500	1	

Note:
■ Stock Items # 1MW (Module Width) = 18mm

Betagard Distributions Boards

Selection and ordering data

Betagard Distribution Boards 8GB3/8GB1

Item Description	Incoming slots	Outgoing slots	Total Slots	Reference No.	Std Pkg Nos.	
Simbox LC (100% Thermoplastic)						
Transparent Cover (Flush Mounted)						
	1 Row, 4Mod	—	—	4	8GB11212	1/5
	1 Row, 8Mod	—	—	8	8GB11213	1/5
	1 Row, 12Mod	—	—	12	■ 8GB11211	1/5
	2 Row, 2 x 12Mod	—	—	24	■ 8GB11221	1/5
	3 Row, 3 x 12Mod	—	—	36	■ 8GB11231	1/5
Transparent Cover (Surface Mounted)						
	1 Row, 12Mod	—	—	12	8GB13211	1/5
	2 Row, 2 x 12Mod	—	—	24	8GB13221	1/5
	3 Row, 3 x 12Mod	—	—	36	8GB13231	1/5
White Cover (Flush Mounted)						
	1 Row, 4Mod	—	—	4	8GB11112	1/5
	1 Row, 8Mod	—	—	8	8GB11113	1/5
	1 Row, 12Mod	—	—	12	■ 8GB11111	1/5
	2 Row, 2 x 12Mod	—	—	24	■ 8GB11121	1/5
	3 Row, 3 x 12Mod	—	—	36	■ 8GB11131	1/5
White Cover (Surface Mounted)						
	1 Row, 12Mod	—	—	12	8GB13111	1/5
	2 Row, 2 x 12Mod	—	—	24	8GB13121	1/5
	3 Row, 3 x 12Mod	—	—	36	8GB13131	1/5
Accessories for Simbox LC						
	N/PE terminal for 5 terminals				8GB20813	10
	N/PE terminal for 7 terminals				8GB20812	10
	N/PE terminal for 12 terminals				8GB20810	10
	N/PE terminal for 16 terminals				8GB20811	10
	Security Lock, Left				8GB20820	10
	Security Lock, Right				8GB20821	10

Note:

■ Stock Items

1MW (Module Width) = 18mm

Beta Flex DB (8GB31) - 2 rows system

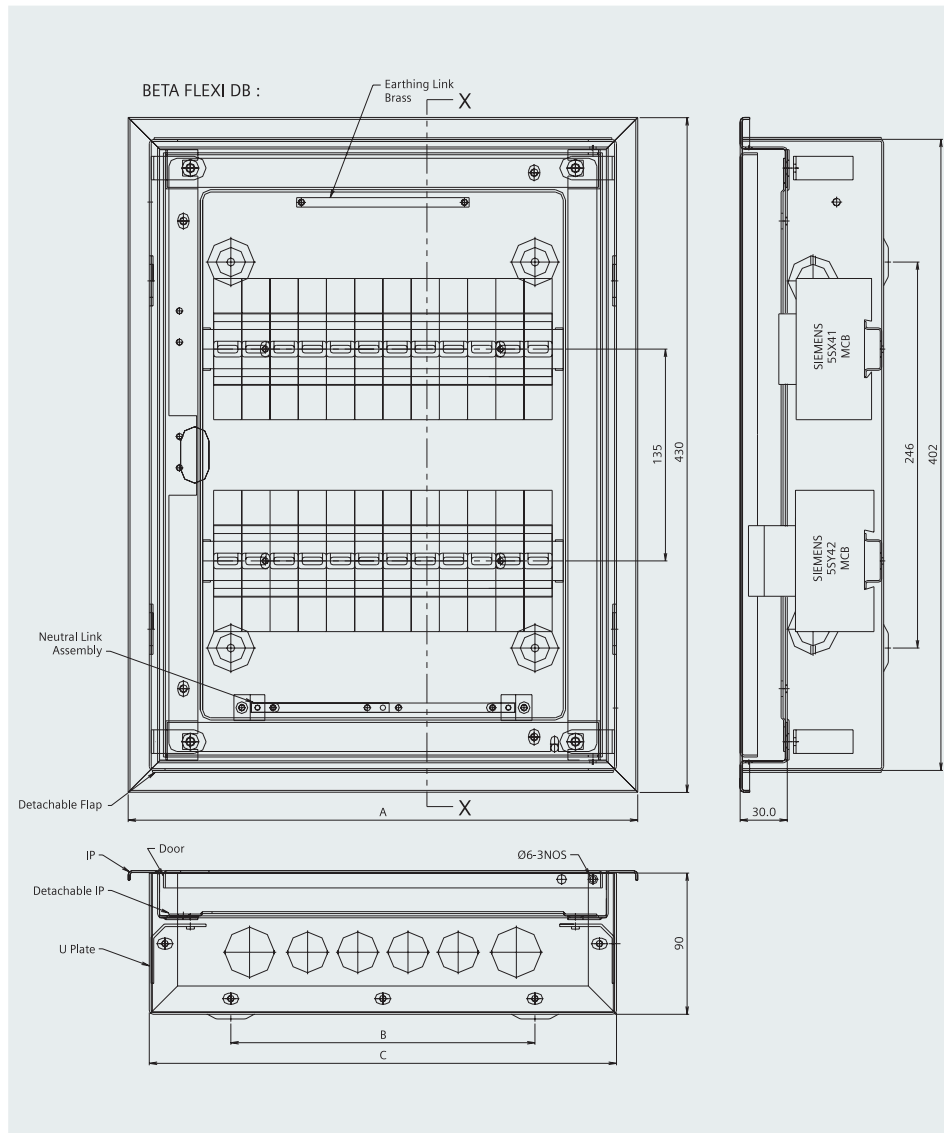

Note:

- 1) Powder coating 100±25µ
- 2) Colour ivory while RAL-9016 shade
- 3) All dimensions are in mm.

Configuration

Type ref	No of slots/row	No of rows	Total
8GB31424RC	12	2	24
8GB31426RC	16	2	32

Dimension (mm)

Model	A	B	C	Knockout		
				Per side (top & bottom)		Per side flap combination Ø32/Ø21 combi
				Combi Ø40/Ø28	Combi Ø32/Ø20	
12 x 2 Rows	345	194	318	2	3	2
16 x 2 Rows	433	282	406	2	5	2

Application: recommended for residential and commercial buildings where-in mounting of modular devices like timers, ammeters, and TP MCBs are to be connected in the outgoing circuits.

Dimensions

Beta Flex DB (8GB31) - 4 rows system

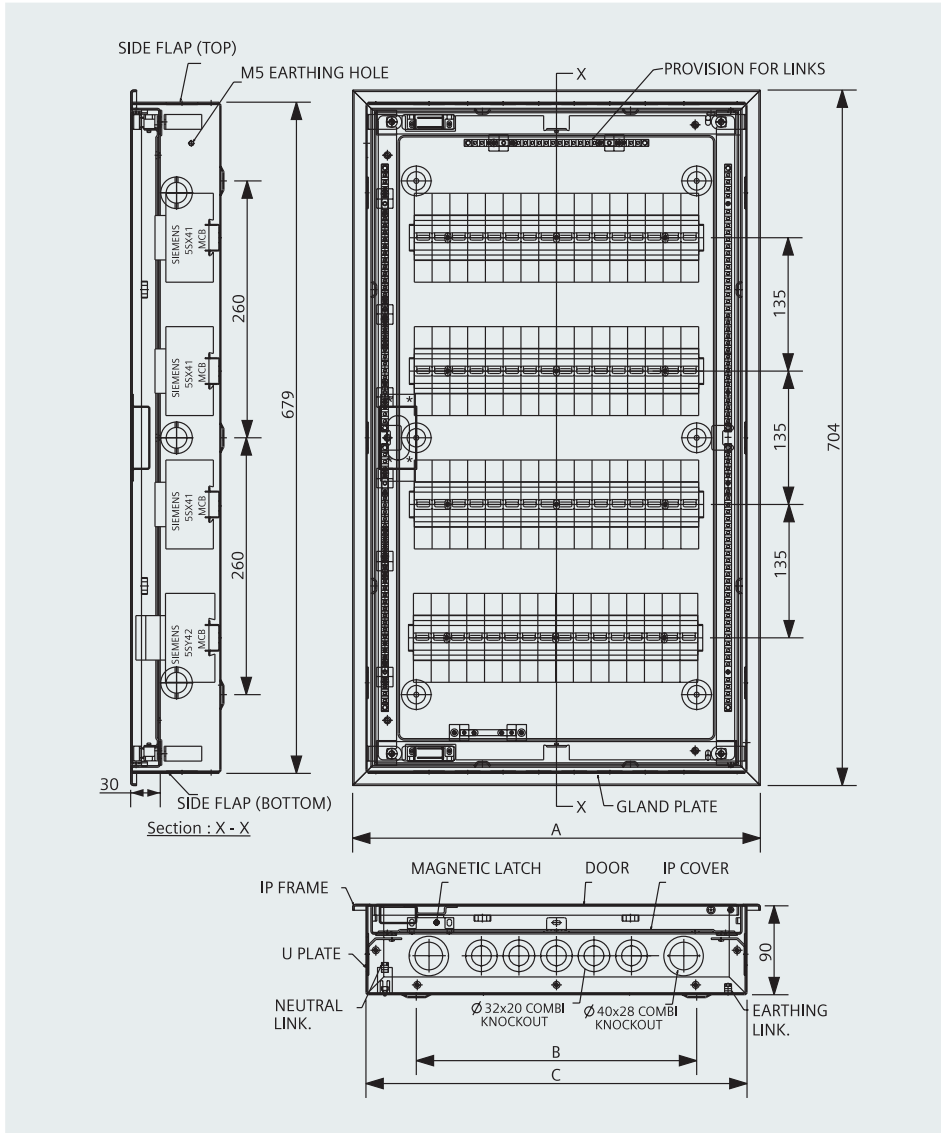

Note:

- 1) Powder coating 100±25µ
- 2) Colour ivory while RAL-9016 shade
- 3) All dimensions are in mm.

Configuration

Type ref	No of slots/row	No of rows	Total
8GB3144 2RC	8	4	32
8GB3144 4RC	12	4	48
8GB3144 6RC	16	4	64

Dimension (mm)

Model	A	B	C	Knockout		
				Per side (top & bottom)		Per side flap Ø32/Ø21 combi
				Combi Ø40/Ø28	Combi Ø32/Ø20	
8 x 4 Rows	273	124	246	2	1	3
12 x 4 Rows	345	196	318	2	3	3
16 x 4 Rows	433	284	406	2	5	3

Application: highly recommended for commercial buildings where-in the total number of circuits are considerably more. Beta flex can offer 16 module X 4 rows design DB which can accommodate 64 modules in total of 55/70mm depth.

Betagard SPN DB (8GB31) with or without TV splitter and krone type telephone socket

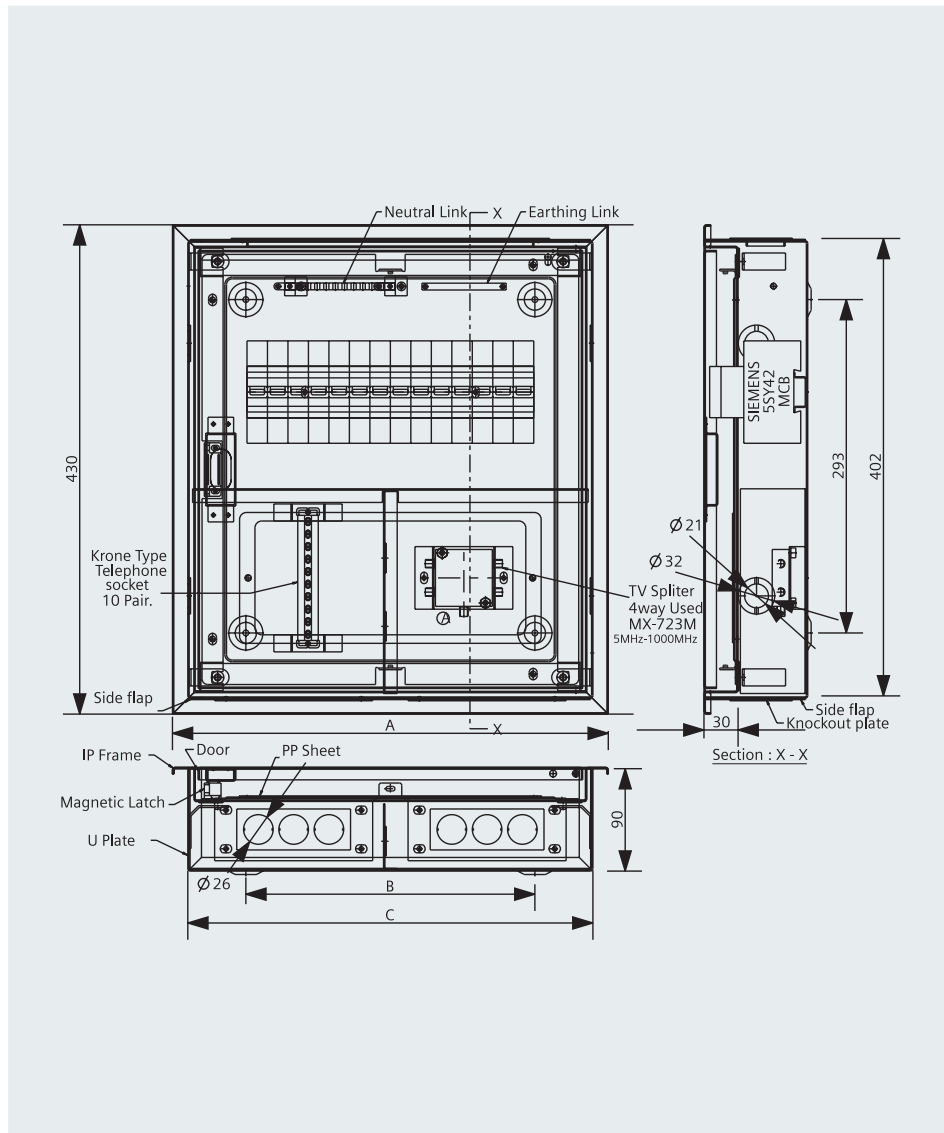

Note:

- 1) Powder coating 100±25µ
- 2) Colour ivory while RAL-9016 shade
- 3) All dimensions are in mm.

Configuration

Type ref	No of slots/row	No of rows	Total
8GB31215RC	14	1	14
8GB31315RC	14	1	14

Dimension (mm)

Model	A	B	C	Knockout		
				Total (top & bottom)		Per side flap size Ø32 & Ø21 combination
				Ø32	Ø26	
8GB31215RC	383	254	356	2	11	2
8GB31315RC	383	254	356	2	11	2

Application: Recommended for single phase power distribution network + TV & telephone connection in one location in order to give better aesthetics and neat wiring.

Dimensions

Betagard TPN DB (8GB31) with or without TV splitter and krone type telephone socket

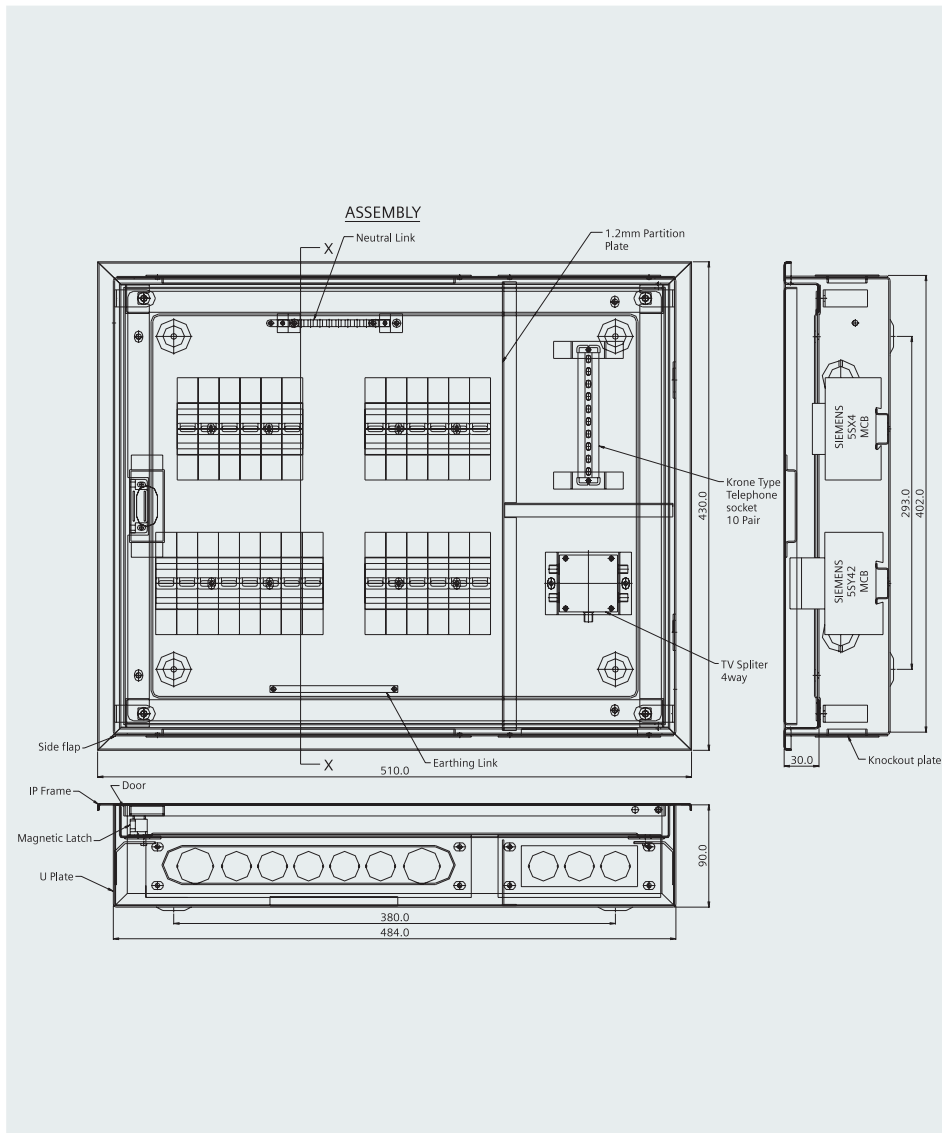

Note:

- 1) Powder coating 100±25µ
- 2) Colour ivory while RAL-9016 shade
- 3) All dimensions are in mm.

Configuration

Type ref	No of slots/row	I/C Slots	O/G Slot	Total
8GB31221RC	6	8	3X 6	26
8GB31321RC	6	8	3X6	26

Dimension (mm)

Model	A	B	C	Knockout		
				Per side (top & bottom)		Per side flap size Ø32 & Ø21 combination
				Ø32	Ø26	
8GB31221RC	510	380	484	2	8	2
8GB31321RC	510	380	484	2	8	2

Application: Recommended for three phase power distribution network + TV & telephone connection in one location in order to give better aesthetics and neat wiring.

Beta Bus DB (8GB31)

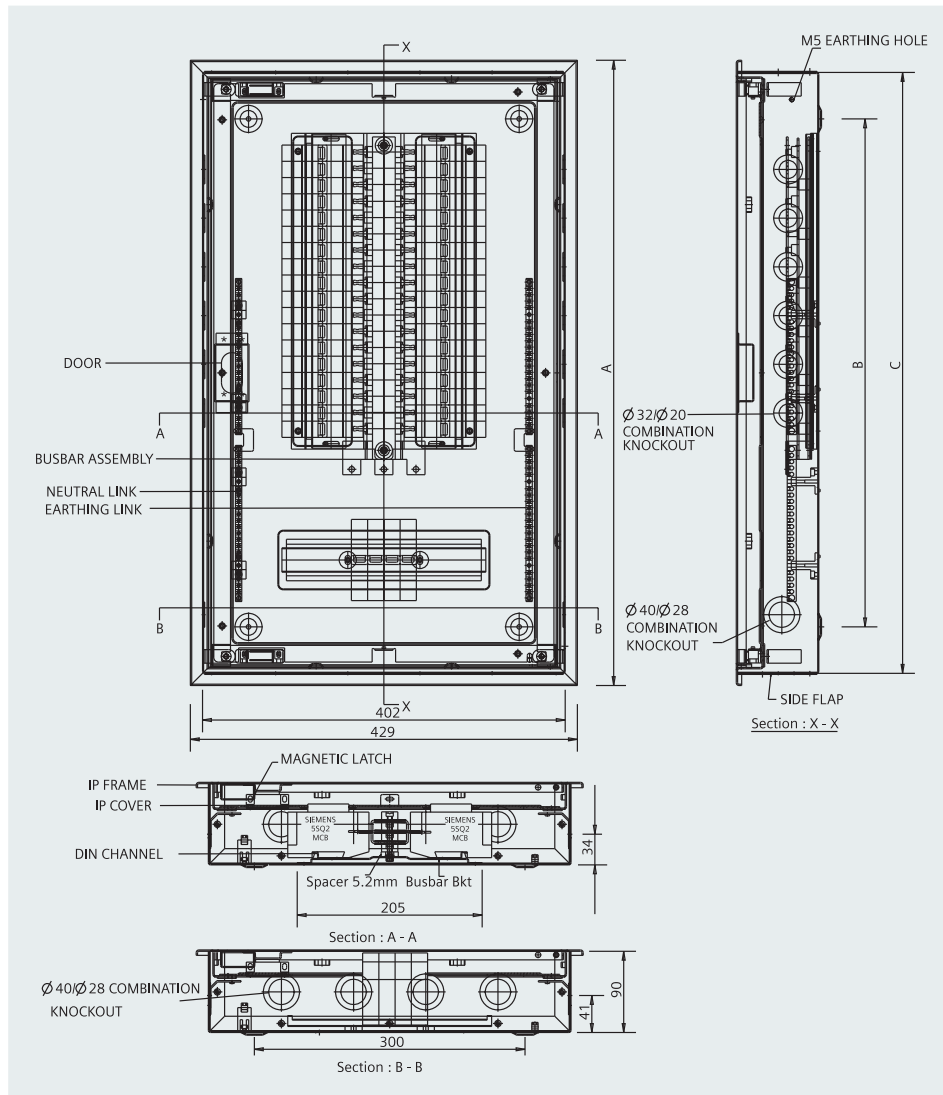

Note:

- 1) Powder coating 100±25µ
- 2) Colour ivory while RAL-9016 shade
- 3) All dimensions are in mm.

Configuration

Type ref	No of ways	I/C slots (MCB+RCCB)	O/G slots TP/SP (V.Bus Bar)
8GB3147 1RC	4	12	4/12
8GB3147 3RC	6	12	6/18
8GB3147 4RC	8	12	8/24
8GB3147 7RC	12	12	12/36

Dimension (mm)

Model	A	B	C	Knockout			
				Top & bottom combination Ø42 & Ø35	Bottom slit	Per side flap combination Ø32 & Ø20	Per side flap combination Ø40 & Ø28
4 Way	477	347	450	4	72 X 46	2	1
6 Way	531	401	504	4	72 X 46	3	1
8 Way	585	455	558	4	72 X 46	4	1
12 Way	693	563	666	4	72 X 46	6	1

Application: Recommended where ever TP/SP MCBS are to be mounted in the outgoing circuits. The ready made insulated vertical bus bar will simplify the wiring job apart from giving total safety.

Dimensions

Beta Bus plus DB with vertical Bus Bar (8GB31)

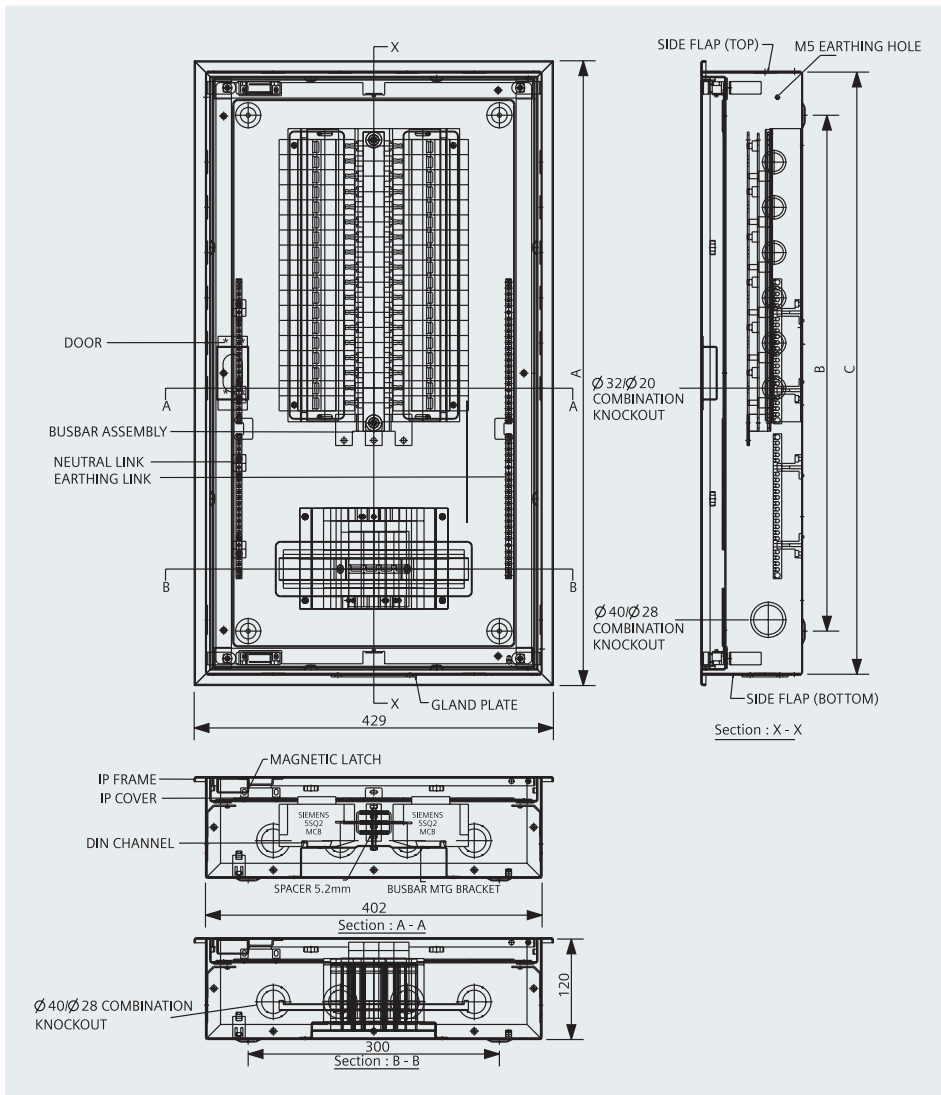

Note:

- 1) Powder coating $100 \pm 25 \mu$
- 2) Colour ivory white RAL-9016 shade
- 3) All dimensions are in mm.

Configuration

Type ref	No of ways	I/C slots (MCB+RCCB)	O/G slots TP/SP (V.Bus Bar)
8GB3157 1RC	4	12	4/12
8GB3157 2RC	6	12	6/18
8GB3157 3RC	8	12	8/24
8GB3157 4RC	12	12	12/36

Dimension (mm)

Model	A	B	C	Knockout			
				Top & bottom combination Ø40/Ø28 (with gland plate)	Bottom slit	Per side flap combination Ø32/Ø20	Per side flap combination Ø40/Ø28
4 Way	530	400	503	4 / 2	72 X 46	2	1
6 Way	584	454	557	4 / 2	72 X 46	3	1
8 Way	638	508	611	4 / 2	72 X 46	4	1
12 Way	746	616	719	4 / 2	72 X 46	6	1

Application: highly Recommended where ever MCCB as incomer up to 160A and TP/SP MCBS are to be mounted in the outgoing circuits. The ready made insulated vertical bus bar will simplify the wiring job apart from giving total safety.

Beta phase change over DB (8GB31)

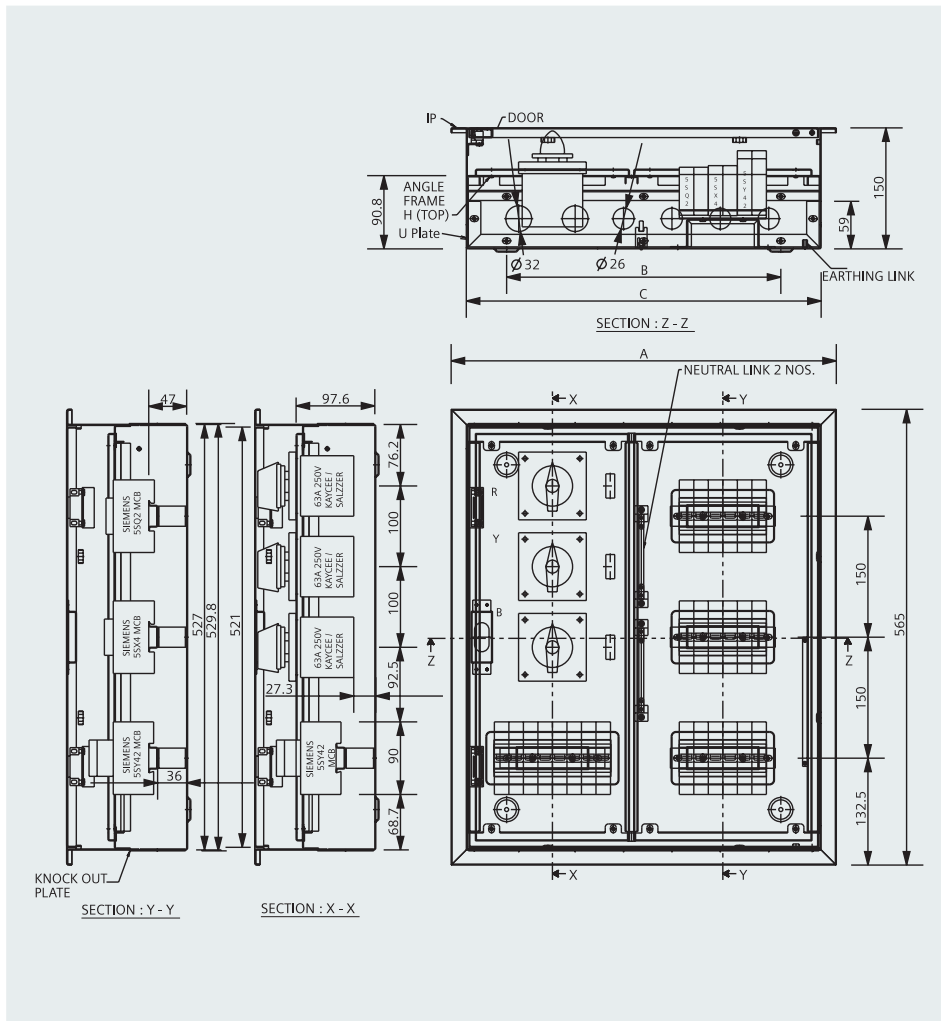

Note:

- 1) Powder coating 100±25µ
- 2) Colour ivory while RAL-9016 shade
- 3) All dimensions are in mm.

Configuration (without 3 Nos. 40A change over switch & LED indication)

Type ref	No of ways (MCB + RCCB)	I/C slots	O/G slot	Total
8GB3184 ORC	4	8	3 X 4	20
8GB3184 1RC	6	8	3 X 6	26
8GB3184 2RC	8	8	3 X 8	32
8GB3184 4RC	12	8	3 X 12	44

MLFB	Type	A	B	C
8GB3184 ORC	4 way	442	313	415
8GB3184 1RC	6 way	477	348	450
8GB3184 2RC	8 way	512	383	485
8GB3184 4RC	12 way	587	458	560

Application: recommended where ever the reliability of 3 phase supplies are not dependable. Beta change over DB will have a feature to shift the load connected to the dead phase to a live one whenever there is a failure of any one phase.

Betagard Distributions Boards

Dimensions

Betagard wire way boxes

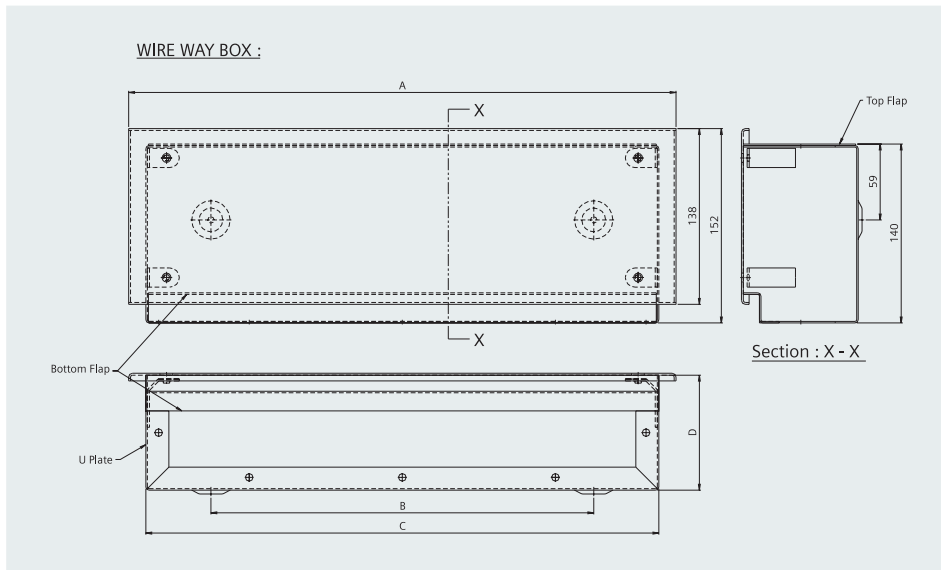

Note:

- 1) Powder coating $100\pm 25\mu$
- 2) Colour ivory white RAL-9016 shade
- 3) All dimensions are in mm.

Suitable for	Config.	Type	A	B	C	D	Nos of MCB Slot
Flexi DB	12 X 2R & 12 X 4R	8GB9912FWWNT	325	226	298	90	12
	8 X 4R	8GB9908FWWNT	253	154	226	90	08
	16 X 2R & 16 X 4R	8GB9916FWWNT	413	314	386	90	16
Beta Bus DB	-	8GB99BUSWWNT	430	300	402	90	12
Beta Bus Plus DB	-	8GB99PLUSWWNT	430	300	402	120	12

Betagard modular device boxes

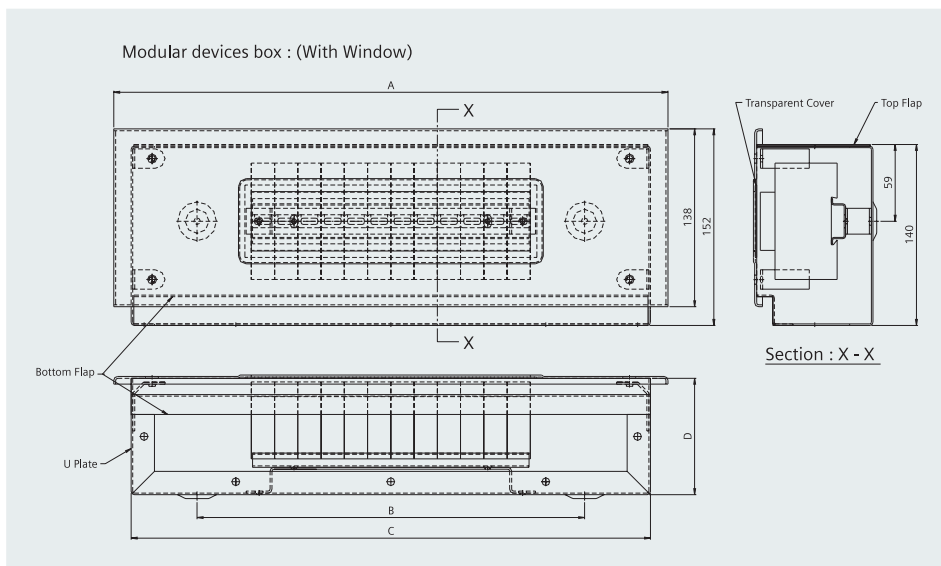

Note:

- 1) Powder coating $100\pm 25\mu$
- 2) Colour ivory white RAL-9016 shade
- 3) All dimensions are in mm.

Suitable for	Config.	Type	A	B	C	D	Nos of MCB slot
Flexi DB	12 X 2R & 12 X 4R	8GB9912FMDTC	325	226	298	90	12
	8 X 4R	8GB9908FMDTC	253	154	226	90	08
	16 X 2R & 16 X 4R	8GB9916FMDTC	413	314	386	90	16
Beta Bus DB	-	8GB99BUSMBTC	430	300	402	90	12
Beta Bus Plus DB	-	8GB99PLUSMBTC	430	300	402	120	12

Simbox LC

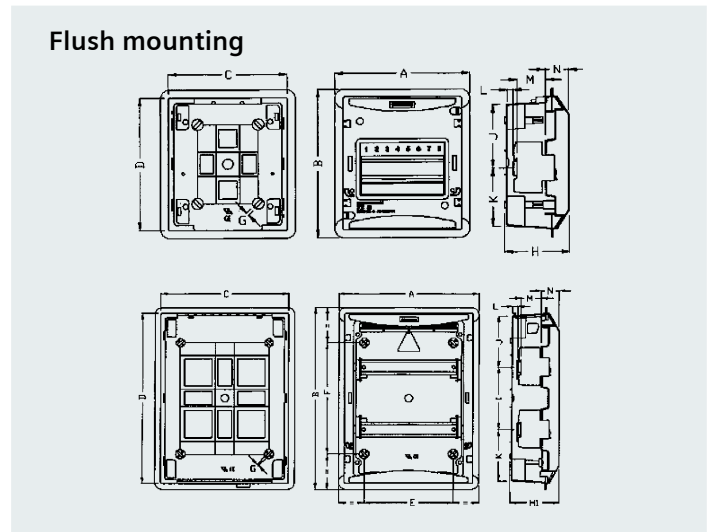
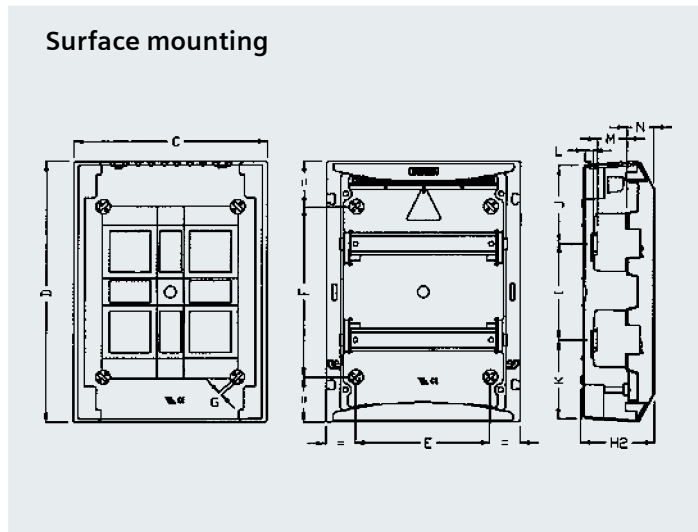

MW	Version	A mm	B mm	H mm	H1 min. mm	H2 mm	C mm	D mm	E mm	F mm	G mm	I mm	J mm	K mm	L mm	L min. mm	L max. mm	M mm	N mm
4	UP	164	264	114	-	-	136	236	65	140	5	-	110	100	12	-	-	48	35
8	UP	236	264	114	-	-	136	236	116	140	5	-	110	100	12	-	-	48	35
12	UP	328	264	-	115	-	300	236	48	130	5	-	120	100	-	12	27	48	35
	AP	-	-	-	-	113	300	236	48	130	5	-	120	100	-	12	25	48	35
24	UP	328	434	-	115	-	300	405	208	266	5	150	120	120	-	12	27	48	35
	AP	-	-	-	-	113	300	405	208	266	5	150	120	120	-	10	25	48	35
36	UP	328	599	-	115	-	300	570	208	430	5	150 x 2	175	120	-	12	27	48	35
	AP	-	-	-	-	113	300	570	208	430	5	150 x 2	175	120	-	10	25	48	35

UP = Flush mounting AP = Surface mounting

Simbox WP

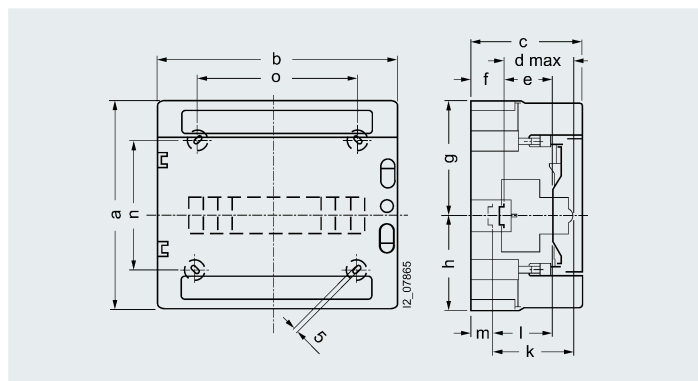

1-tier 8GB1 371-0, 8GB1 371-1, 8GB1 371-2, 8GB1 371-3

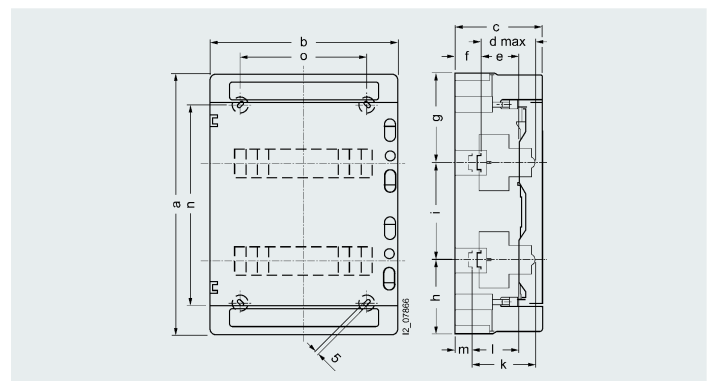

2-tier 8GB1 372-2, 8GB 372-3 (3- and 4-tier versions not shown)

MW	Type	Dimensions													
		a	b	c	d _{max}	e	f	g	h	i	k	l	m	n	o
1 x 4	8GB1 371-0	210	148	100	75	48	15	105	105	-	-	-	-	156	87
1 x 8	8GB1 371-1	210	215	100	75	48	15	105	105	-	-	-	-	110	87
1 x 12	8GB1 371-2	260	298	140	75	48	48	117.5	142.5	-	102	75	21	161	200
1 x 18	8GB1 371-3	285	410	140	75	48	48	117.5	142.5	-	102	75	21	185	310
2 x 12	8GB1 372-2	420	298	140	75	48	48	147.5	122.5	150	102	75	21	320	200
2 x 18	8GB1 372-3	463	410	140	75	48	48	155.5	131.5	150	102	75	21	210	293
3 x 18	8GB1 373-3	655	410	140	75	48	48	162.5	142.5	175	102	75	21	363	319
4 x 18	8GB1 374-3	878	410	160	75	48	48	175	155.5	175	102	75	21	394	319

a = Distribution board height b = Distribution board width c = Distribution board depth
 g = Device mounting depth h = Wiring space behind the standard mounting rail

Wiring instructions

Three Phase Incoming & TP/SP outgoing with vertical busbar system

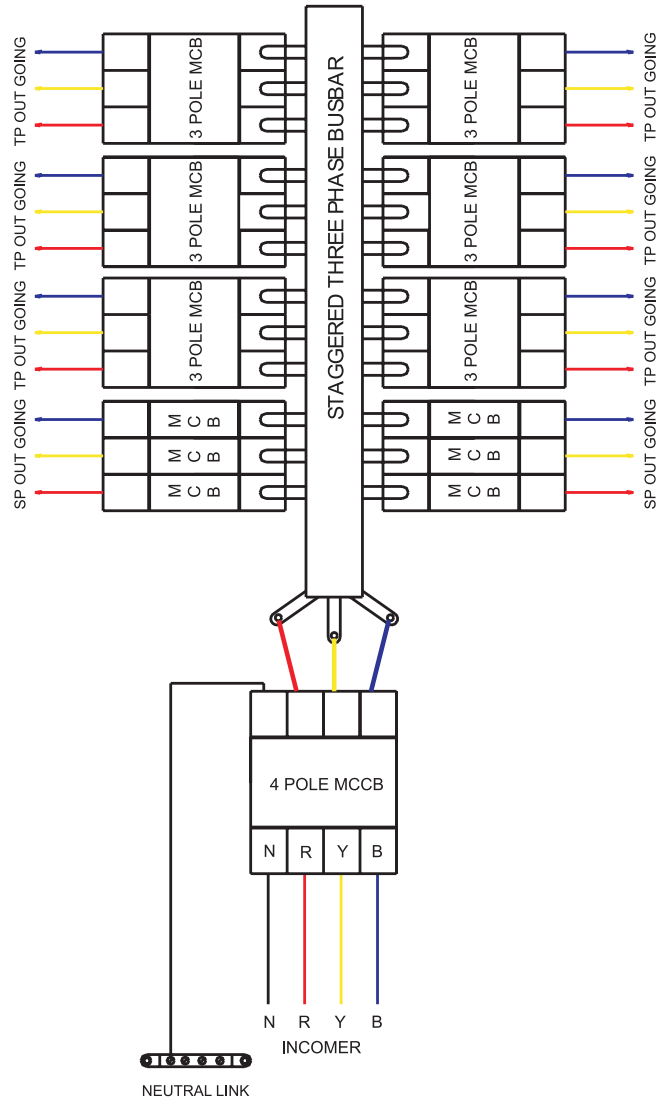

Beta Bus: 125A 5SP4, 63A 5SX4, 5SJ4 and 5SQ2 as an incomer and SP/TP MCB upto 63A 5SX4 as an outgoing

Beta Bus Plus: 160A 3VT1 MCCB as an incomer and SP/TP MCB upto 63A 5SX4 as an outgoing

Automatic Transfer Switching Equipment - ATSE

4

Power... When it matters the most!

4/2	Overview
4/3	Selection & ordering
4/4	Technical specifications
4/5	ATSE types
4/6	Dimensional details
4/7	Schematics
4/8	ATSE in a power distribution



Overview

Background:

Back up power source has become an integral part of almost every commercial, residential & industrial installation. Many of the residential or commercial project developers provide to their occupants availability of continuous power especially for critical applications such as lifts, lobby lighting, operation of water pumps etc. To provide power at all times for above applications a backup power source is used. It could be DG or from other utility as a stand by power source.

This would typically necessitate use of switching and changeover devices. Betagard 5TR ATSE is a solution for the above applications for DG sets upto 82.5kVA or a power source from which load can draw maximum 125A.

Betagard ATSE has two separate MCBs one for Normal power and the other for backup power. Electronic controller mechanically operates these MCBs and performs

automatic and safe changeover of power supply. It conforms to latest standard IS/IEC 60947-6.

In event of power failure or under voltage condition Betagard 5TR ATSE automatically shifts the load from normal power supply to back up power supply. This changeover is initiated once backup power source is available at incoming of backup MCB.

Once normal power supply restores, it waits for a user defined delay time and then it shifts back from backup power supply to normal power supply.

Betagard 5TR ATSE is available in two versions i.e. Basic & Advance. One of the key visible differences in Advance version is a LED display on the controller for settings apart from some more features and operational differences.



Selection & ordering



Benefits:

- Prewired solution provides ease in installation
- Prewired and ready to install product. (Controller + 2 no of MCBs upto 125A)
- Simple Switching device which also protects.
- Available for single phase and three phase applications.
- Front panel LED indications as well as contacts for external indications.
- Protection against under voltage (Fixed at 70% Un in Basic Type & Adjustable from 70-85% Un in Advance type) and phase failure.
- Mechanical Interlock using two position lever.
- Shrouded outgoing terminals
- Automatic as well as manual operation.
- Adjustable transfer time from 1.5secs to 60secs
- MCB Trip / Contact weld indication with Alarm function.
- Emergency shut down signal input (From fire system or some other external source in Advance type)

Applications:

- Common Area Lighting in residential Complexes and commercial Installations.
- Lift Back up Supply in the event of power failure in Residential Apartments and Societies.
- Small Commercial Establishments e.g. Shopping Complex etc
- Data Centre and Server room back up.
- Change over for Back up supply for individual Residences in Apartments and Bungalows.

Selection & ordering data

	No. of MCB Poles	Rated current I_n (A)	Reference No.	Std. Pkg. (Nos.)
Basic Version (without display)				
	2-Pole	40	5TR13328RC40	1
		63	5TR13328RC63	1
		100	5TR13327RC81	1
		125	5TR13327RC82	1
	4-Pole	40	5TR13348RC40	1
		63	5TR13348RC63	1
		100	5TR13347RC81	1
		125	5TR13347RC82	1
Advanced Version (with display)				
	2-Pole	40	5TR23328RC40	1
		63	5TR23328RC63	1
		100	5TR23327RC81	1
		125	5TR23327RC82	1
	4-Pole	40	5TR23348RC40	1
		63	5TR23348RC63	1
		100	5TR23347RC81	1
		125	5TR23347RC82	1

Automatic Transfer Switching Equipment - ATSE

Technical specifications

Technical Specifications

		5TR1	5TR2
Standards		IS/IEC 60947-6	
Rated Control Supply voltage	Vac	AC240V (Sourced from Power & backup supply MCB incoming terminals)	
Rated operational Voltage	Ue	240/415 Vac	
Rated Frequency	Hz	50	
Rated Current	A	40, 63, 80, 125A*	
Utilisation Category		AC 33B [#]	
Rated breaking capacity according to 60898-1 (Icn)	KA	10KA	
Rated breaking capacity according to 60947-2 (Icu)	KA	15KA for 40 & 63A, 20KA for 100 & 125A	
Controller			
Transfer delay Adjustment		Analog (Using Pot)	Digital (Switch)
Minimum transfer Time	Sec	1.5~2.5s	
Operating transfer time	Sec	instantaneous~60s	
Return Transfer Time	Sec	instantaneous~60s	
Under voltage setting	%	70~Ue (fixed)	70~85~Ue (settable)
MCB Trip / Contact Weld alarm indication		Yes	
External Indication Contacts		AC240V, <40W	
Remote controlled Emergency Shut Down (24V DC)		No	Yes
Outgoing Terminals			
Connection type		Nut-Bolt terminal for ring / fork type lug	
Conductor Cross Section	Sq mm	16-50 Sqmm for 40 & 63A, 16-95 Sqmm for 100& 125A	
Terminal Tightening torque	Nm	3 Nm for 40 & 63A, 10 Nm for 100& 125A	
Stripping length / Bolt Size		18 mm / M6 for 40 & 63A, 18mm / M8 for 100& 125A	
Functions			
Auto Transfer on Phase failure / Undervoltage		Yes	
Auto throw Auto return ¹		Yes	
Auto throw without auto return ²		Yes	
Manual Operation using Push Button		No	Yes
Manual operation using external handle		Yes	
Third state ³		Yes	
Net –Net mode ⁴		Yes	
Net-generator mode ⁵		No	Yes

[#] AC 33B - Motor Loads or Mixed loads including motors, resistive loads and up to 30% Incandescent lamp Loads

¹ In case of normal power supply failure, ATSE will transfer from normal supply to backup supply automatically and once the normal power supply recovers, ATSE returns automatically from backup power supply to normal power supply.

² In case of normal power supply failure, ATSE will transfer from normal supply to backup supply automatically and once the normal power supply recovers, ATSE does not return from backup power supply to normal power supply.

³ Both MCBs in OFF position (Total Shut Down)

⁴ In this mode backup is considered to be available all the time. No signal from will be generated at ATSE for Generator as start command on failure of normal power supply.

⁵ In this mode backup power is a generator power supply and a signal output is generated from ATSE which is used for generator as start command.

* 40A & 63A MCBs are of D Characteristics and 100 & 125A MCBs are of C characteristics

ATSE type

ATSE Operation: 5TR1 Basic Type

10 5TR1 ATSE

60s 60s
30s 30s
0 0
Transfer Delay Return Delay

1 2 3 4

I Un Normal Power II Ub Backup Power

TEST SET

MANUAL
ATWAR
ATAR

5 6 7 8 9

Rated operational voltage: 240V 50Hz
Reference Standard: IS 13947-6-1/IEC60947-6-1 (AC-33B)

SIEMENS

5TR1 ATSE front panel

- Indicator for Normal Power Supply
- Indicator for Back Up Power Supply
- Indicator for Operating State (Refer – Table 2)
- Key for Test / Set / Alarm Acknowledge
- Indicator for Back up supply MCB Trip / Weld condition
- Indicator for Back Up supply MCB status
- Indicator for Normal supply MCB status
- Indicator for Normal supply MCB Trip / Weld condition
- Pot for Operating transfer time adjustment
- Pot for Return Transfer time adjustment

ATSE Operation: 5TR2 Advanced Type

13 5TR2 ATSE

1 2 3 4

I Un Normal Power II Ub Backup Power

Manual AUTO

ION

II ON

OFF +/-

Enter

AXX0	ATAR
AXX1	ATWAR
BXX0	Power Network
BXX1	Generator

5 6 7 8 9 10 11 12

Rated operational voltage: 240V 50Hz
Reference Standard: IS 13947-6-1/IEC60947-6-1 (AC-33B)

SIEMENS

5TR2 front panel

- Indicator for Normal Power Supply
- Indicator for Back Up Power Supply
- Indicator for Operating mode (OFF for manual & ON for Auto)
- Key for Manual / Auto mode setting
- Key for transfer to normal power supply / Alarm Acknowledge
- Key for transfer to backup power supply / Cursor shift to left
- Key to turn both MCBs OFF/ Mode selection
- Key for Function Setting
- Indicator for Back up supply MCB Trip / Weld condition
- Indicator for Back Up supply MCB status
- Indicator for Normal supply MCB status
- Indicator for Normal supply MCB Trip / Weld condition
- 7 Segment Display

Dimensional details

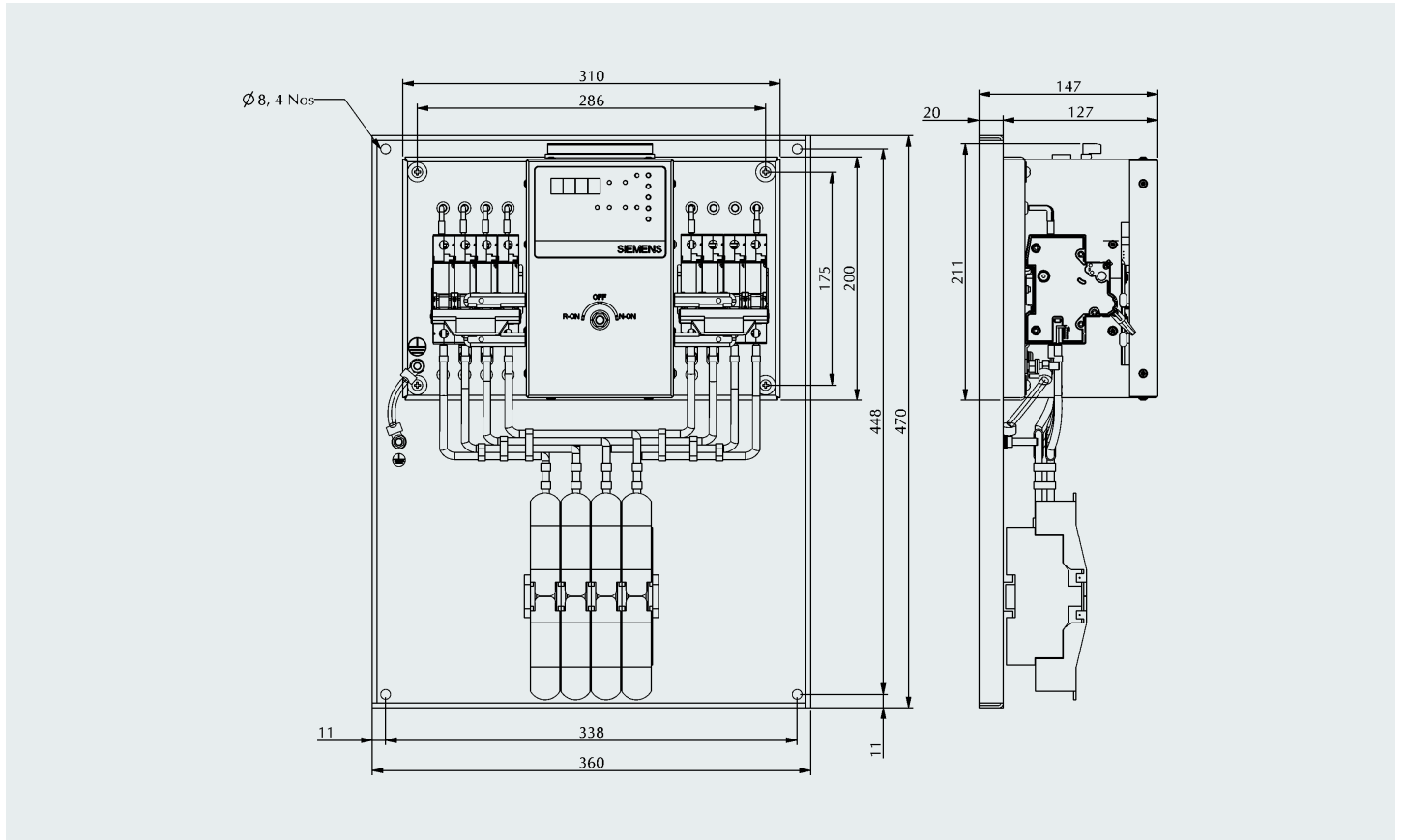

Figure 1: Dimensions (5TR1& 5TR2 with rated current 40 & 63A)

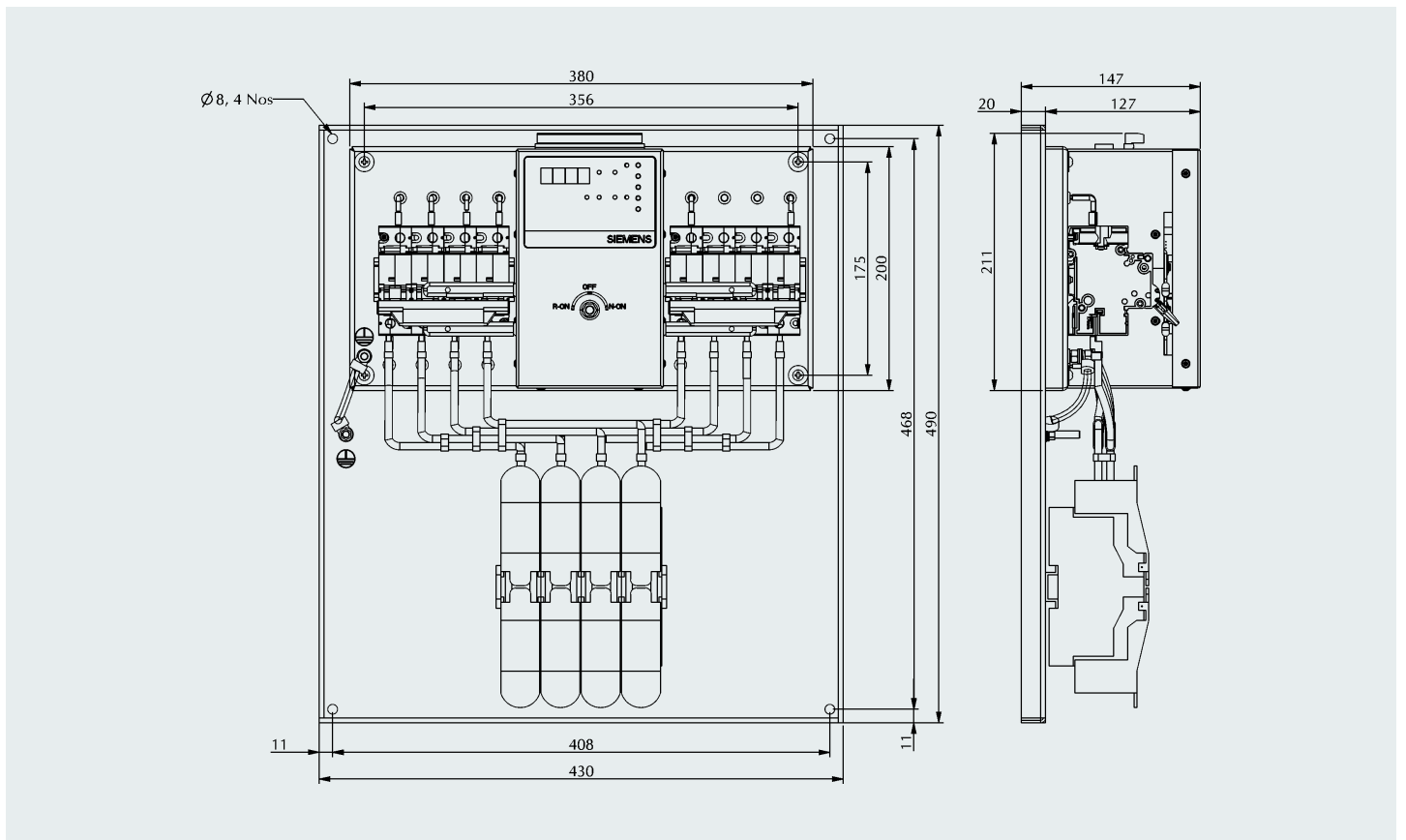

Figure 2: Dimensions (5TR1& 5TR2 with rated current 100A & 125A)

Schematics

Wiring

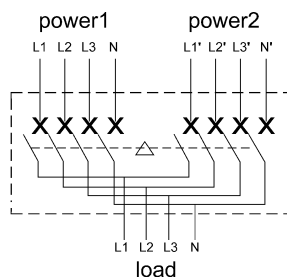

Figure 3: ATSE main system with neutral line

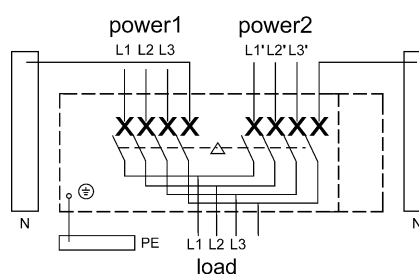

Figure 4: ATSE main system without neutral line

Indication and wiring of control system

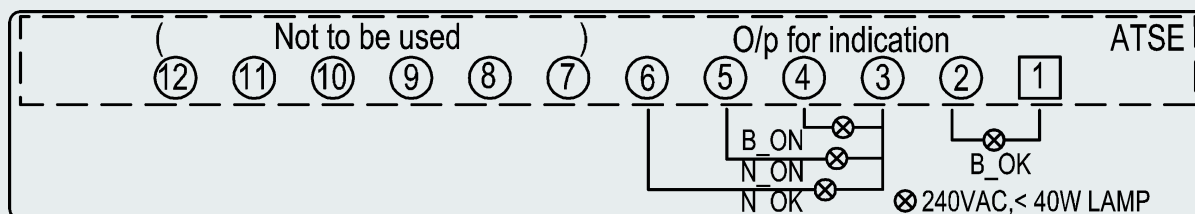

Figure 5: 5TR1 type ATSE output terminal

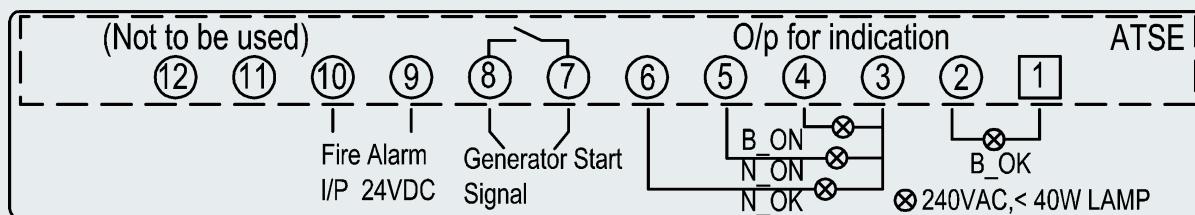

Figure 6: 5TR2 type ATSE out put terminal

Indication:

In 5TR series, 240V AC output voltage is used for indication

- Terminal 1 & 2, 240V AC output point for indication of availability of Back up supply (supplied from Back up power)
- Terminal 3 & 4, 240V AC output point, for indication of the load is on Backup supply (supplied from normal power)
- Terminal 3 & 5, 240V AC output point for indication of the load is on Normal supply (supplied from normal power)
- Terminal 3 & 6, 240V AC output point for indication of availability of normal supply (supplied from normal power)

Generator set start Signal: 5TR2 ATSE has potential free output point for starting the generator set. This contact is Normally Closed when normal power is available and change to Normally Open on mains failure. Works only in net-generator mode

Fire Alarm input: 5TR2 ATSE has fire control signal terminal. In case of emergency, 24V DC input between terminal 10 & 9 will transfer ATSE to third state i.e. complete shutdown of normal and backup power.

Automatic Transfer Switching Equipment - ATSE

ATSE in a power distribution

Use of ATSE in an electrical power supply system

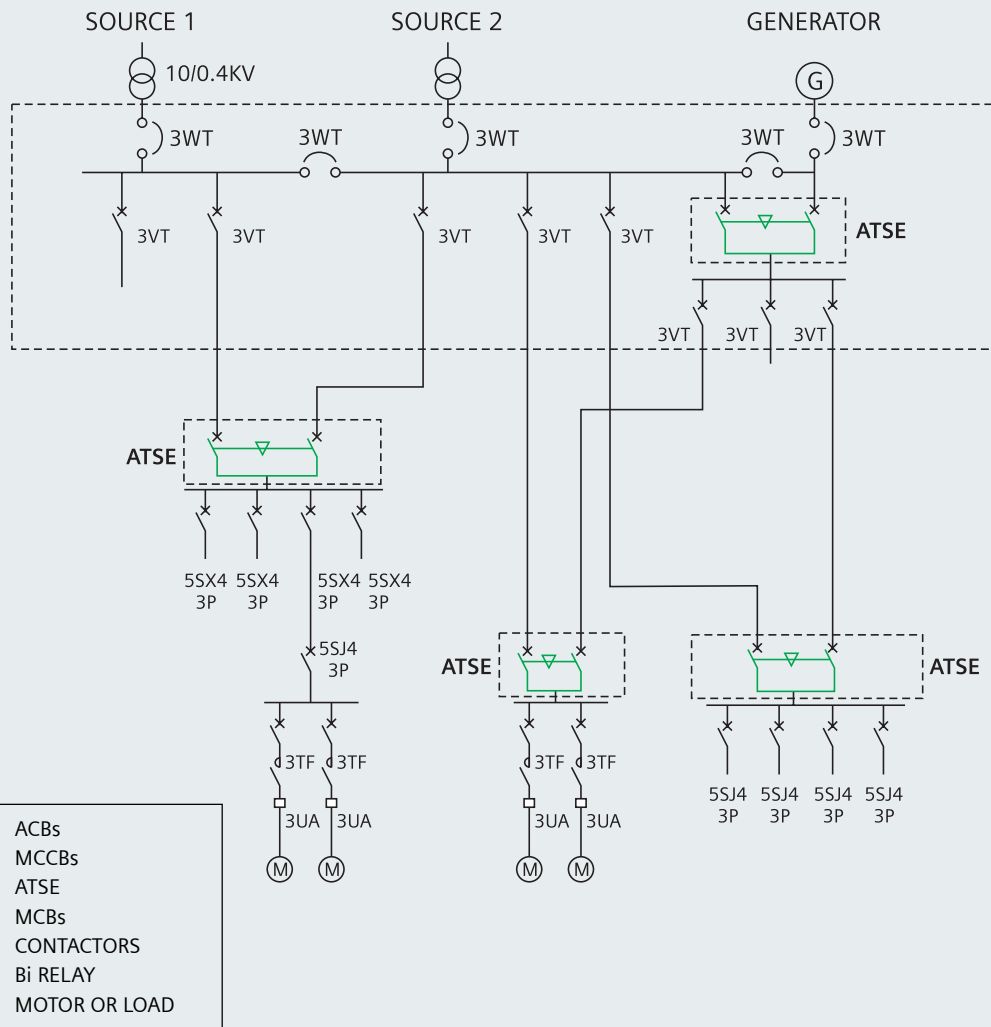

Your partners

Sales offices:

Ahmedabad

3rd Floor, Prerna Arbur
Girish Cold Drinks Cross Roads, Off G.C.Road
Ahmedabad - 380 009
☎ : +91 79 40207600
Fax: +91 79 40207699

Bengaluru

1st Floor, Jyoti Mahal, No. 49, St. Marks Road
Bengaluru - 560 001
☎ : +91 80 22042000
Fax: +91 80 22224131

Chandigarh

SCO 188/191, 3rd Floor, Sector-17 C
Chandigarh - 160 017
☎ : +91 172 4690300
Fax: +91 172 4690399

Territory managers:

Aurangabad

A9, Yogeshwari Vrundavan, Nr. Malhar Chowk
Garkheda Parisar, Prem Nagar
Aurangabad - 431210, Maharashtra
Mobile: +91 9766316446
E-mail: santosh.rajhans@siemens.com

Belgaum

H.No.713, Narvekar Lane, Shahpur
Belgaum - 590003, Karnataka
☎ : +91 831 2495156
Mobile: +91 9740277991
E-mail: anand.gawade@siemens.com

Bhilai

25/2, Nehru Nagar (West), SBI Colony
Bhilai - 490020, Chhattisgarh
Mobile: +91 7869913404
E-mail: Yet to create

Bhopal

Flat No-104, Sagar Home Phase-2
Sarvadhama Society, Nayapura Road
Bhopal - 462042
Mobile: +91 9977228084
E-mail: prajwal.khapekar@siemens.com

Bhuwaneswar

Flat No. 109, Hara Priya Apartment, Vivekanand Marg
Bhuwaneswar - 751002, Orissa
☎ : +91 674 2430734
Mobile: +91 9937009749
E-mail: anirban.aditya@siemens.com
Mobile: +91 9937097504
E-mail: sumit.sengupta@siemens.com
Mobile: +91 9583061766
E-mail: samuel.prasad@siemens.com

Cochin

K.G.Oxford Business Centre
3A, Shreekandath Rd, Ravipuram
Cochin - 682016
☎ : 91 4028611/22
Mobile: +91 9387384848
E-mail: sudheer.ts@siemens.com
Mobile: +91 9744511109
E-mail: sajeen.s@siemens.com
Mobile: +91 9895052944
E-mail: sreekanth.p@siemens.com

Durg

Adarshnagar, Borsi Road, Ward No.43
H.No.843, Nr. Panchsheel School
Durg - 491001, Chattisgarh
Mobile: +91 9425016197
E-mail: jitendra.potdar@siemens.com

Guwahati

G-1, Hill View Apartment
Navagraha Path, Chenikuthi Hill Side
Guwahati - 781003, Assam
Mobile: +91 9864110684
E-mail: biplab.dutta@siemens.com
Mobile: +91 9435346708
E-mail: Sourav.Bhattacharya@siemens.com

Hardwar

6, Nand Puri, Nr. Aya Nagar Chowk, Jwalapur
Hardwar - 249407, Uttarkhand
☎ : +91 1334 251943
Mobile: +91 9897070133
E-mail: ankur.singh@siemens.com

Hubli

24, 2nd Cross Street, Kadashwar colony
Hubli - 580023, Karnataka
☎ : +91 836 2282947
Mobile: +91 9880662047
E-mail: balajim@siemens.com

Chennai

Sathak Centre, No.4., Mahatma Gandhi Road
Chennai - 600034
☎ : +91 44 28334000
Fax: +91 44 28334088

Coimbatore

7th Floor, Global Towers, 1057, Avinash Road
Coimbatore - 641 018
☎ : +91 422 4336300
Fax: +91 422 4336310

Hyderabad

5-9-19, 4th & 5th Floor, Laxmi Narasinh Estate
Opp. Secretariat Road, Saifabad
Hyderabad - 500 004
☎ : +91 40 2348 2500
Fax: +91 40 23243145

Indore

Flat No. 102, Panchavati Apart.
40 Chandralok Colony, Khajrana Road
Indore - 452001, Madhya Pradesh
Mobile: +91 9926939993
E-mail: prashant.joshi@siemens.com

Jaipur

6, Park Street, Opp. Pink City Petrol Pump, M.I.Road
Jaipur - 302006, Rajasthan
☎ : +91 141 2370274, 2377956
E-mail: ravi.dhingra@siemens.com

Jaipur

6, Park Street, Opp. Pink City Petrol Pump, M.I.Road
Jaipur - 302006, Rajasthan
☎ : +91 141 5152108
Mobile: +91 9829244313
E-mail: gupta.arun@siemens.com

Jalandar

H.No.943, Urban Estate, Phase I
Jalandar - 144022, Punjab
☎ : +91 181 4613929
Mobile: +91 9876047929
E-mail: sunil.singla@siemens.com

Jamshedpur

823, Udaigiri Vijaya Heritage, Uliyan, Kadma
Jamshedpur - 831005, Jharkhand
☎ : +91 657 6451637
Mobile: +91 9934311352
E-mail: shaibal.parial@siemens.com

Jodhpur

371, Gauri House, Kamala Nehru Nagar, Nr. SBI Bank
Jodhpur - 342008, Rajasthan
☎ : +91 291 2760371
Mobile: +91 9828327200
E-mail: naveen.sahariya@siemens.com

Kanpur

106, Agarwal Apart.
Nr. Hari Har Dham Mandir, Shyam Nagar
Kanpur - 208013, Uttar Pradesh
☎ : +91 512 2423348
Mobile: +91 9839102434
E-mail: atul.shukla@siemens.com

Kolhapur

Flat No.101, Shrushti Mahabharat Apartment
Mahavir Garden to Mahavir College Road, Nagala Park
Kolhapur - 416003
☎ : +91 231 2663330
Mobile: +91 9881465421
E-mail: sachin.chavan@siemens.com

Ludhiana

H.No.92, Lajpat Nagar, Near Bus Stand
Ludhiana - 141002, Punjab
☎ : +91 161 2770574
Mobile: +91 9815502480
E-mail: rohit.jagga@siemens.com

Ludhiana

H.No.3746, First Floor, Sector-32-A, Chandigarh Road
Ludhiana - 141010, Punjab
☎ : +91 161 5024702
Mobile: +91 9780300771
E-mail: Rajeiv.Kapoor@siemens.com

Ludhiana

H.No.3996, 1st Floor, Sector-32/A, Chandigarh Rd.
Ludhiana
☎ : +91 161 5017742
Mobile: +91 9878098612
E-mail: amitoj.singh@siemens.com

Madurai

8/12, Ground Flr, Sakthi Vellammal Street, SS Colony
Madurai - 625010, Tamil Nadu
Mobile: +91 9894617780
E-mail: mahendriram.murugan@siemens.com

Kolkata

43, Shanti Palli, Rashbihari Bypass Connector
Eastern Metropolitan Bypass
Kolkata - 700 042
☎ : +91 33 2444 9000, 24428641-47
Fax: +91 33 2444 9010/13

Lucknow

28/45, Ashok Marg, Opp. Indira Bhawan
Lucknow - 226001
☎ : +91 522 4031022, 4031000
Fax: +91 522 4031019

Mumbai

8th Floor, R&D Technology Centre
Thane Belapur Road, Airoli Node
Navi Mumbai - 400 708
☎ : +91 22 2764 5005-6
Fax: +91 22 27645867

Nasik

"Aditya Avenue", Flat No.27, 4th Floor
B-Wing, Near Chandak Circle, Tidke Colony
Nasik - 422001, Maharashtra
Mobile: +91 9822193204
E-mail: kiran.kanhurkar@siemens.com

Nasik

A-12, Eshwar Park, Behind Nasik Cambridge School
Opp. Church, Indira Nagar
Nasik - 422009
Mobile: +91 9823477735
E-mail: ramshankar.chaudhari@siemens.com

Pondicherry

SELVAN ILLAM, 2nd Floor, No. 1
Villianoor Road, Nadesan Nagar
Pondicherry - 605005
Mobile: +91 9840143536
E-mail: lakshmanan.s@siemens.com

Raipur

Flat.No.103, First Floor, Block-B, Shilp Enclave
Nr.LAS Colony, Shankar Nagar
Raipur - 492007, Chhattisgarh
Mobile: +91 9425057945
E-mail: brajesh.rathor@siemens.com

Rajkot

"Vrujraj", Chandanpark Society
Opp. Gyanganga Vidhyapith, Nr. Raiya Circle
Rajkot - 360005, Gujarat
Mobile: +91 9825021026
E-mail: hiren.raythatha@siemens.com

Ranchi

H-1/187, Harmu Housing Colony, Harmu
Ranchi - 834002, Jharkhand
Mobile: +91 9234610953
E-mail: sourav.dasgupta@siemens.com

Renukoot

Above ICICI Prudential Office
Patel Nagar, Murdhawa, Dist. Sonbhadra
Renukoot - 231217, Uttar Pradesh
☎ : +91 544 254693
Mobile: +91 9838007897
E-mail: bhav.srivastava@siemens.com

Rourkela

T-15, Civil Town
Rourkela - 769004, Orissa
☎ : +91 661 2400880
Mobile: +91 9437041724
E-mail: sanjoy.ganguly@siemens.com

Salem

3/25, Santosh Nagar, PACB Backside, Chinnathirupathi
Salem - 8
☎ : +91 427 2401981
Mobile: +91 9894617772
E-mail: rubengerald.s@siemens.com

Sambalpur

Pradhan Para, Near Jamkani Mandir
Beside LIC Div. Off, Ainthapalli
Sambalpur - 768004, Orissa
☎ : +91 663 2541258
Mobile: +91 9438529778
E-mail: samir.chintak@siemens.com

Surat

Flat No. 202, D-1, Suryam Residence, Cause Way Road
Opp. Hari Darshan, Shinganpor-Dabholi Road, Katargam
Surat - 395004, Gujarat
Mobile: +91 9925001779
E-mail: chandrakant.keshrani@siemens.com

Surat

32, 33, Dattatrey Society
Mora Bhagal Char Rasta, Rander Road
Surat - 395005, Gujarat
Mobile: +91 9879510191
E-mail: chintan.naik@siemens.com

Nagpur

5th Floor, Land Mark Building
Wardha Road, Ramdas Peth
Nagpur - 440 010
☎ : +91 712 6633000
Fax: +91 712 6633111

New Delhi

4A, Ring Road, I.P.Estate, Box.No.7036
New Delhi - 110 002
☎ : +91 11 2345 5000-09
Fax: +91 11 42995030

Pune

Tower B/701-705, ICC Trade Tower
403A, Senapati Bapat Road
Pune - 411016
☎ : +91 20 2570 6000
Fax: +91 20 2570 6060

Trichy

Door No.106, Grd. Flr., 5th Cross Street
Vidyalalai Road, Ganapathy Nagar, Thiruvanan Koil
Trichy - 5
☎ : +91 431 4345621
Mobile: +91 9840843121
E-mail: k.saravanakumar@siemens.com

Trivandrum

Udayakiran, T.C.No.28/535
Krishnakovil Road, Kalthamukku
Trivandrum - 695024, Kerala
Mobile: +91 9895979604
E-mail: antony.john@siemens.com

Udaipur

303, Oasis Park, PP Singhal Marg, Ambavgarh
Udaipur - 313001, Rajasthan
☎ : +91 294 2430345
Mobile: +91 9829039120
E-mail: ajit.parashar@siemens.com

Rudrapur

13/14, Model Colony, Nr.Gopinath Mandir
Station Road, Distt.Udhamsingh Nagar
Rudrapur - 263153, Uttarkhand
Mobile: +91 9839813707
E-mail: singh.ajay@siemens.com

Vadodara

3rd Floor, Ohm Business Park
Opp. Balaji Hospital, Ellora Park, Subhanpura
Vadodara - 390023
☎ : +91 265 6692121
Mobile: +91 9825506962
E-mail: bhushan.sawant@siemens.com
Mobile: +91 9825069175
E-mail: mukesh.dobariya@siemens.com

Vapi

Flat No.302, Samrajya IV, Royal Residency
Gokul Vihar Township, Charwad Road
Vapi - 396195, Gujarat
☎ : +91 260 6451156
Mobile: +91 9825147957
E-mail: sachin.paradkar@siemens.com

Vapi

Flat No.203, Plot No.55
Kadri Manzil, Godal Nagar, Distt. Valsar
Vapi - 396191
Mobile: +91 9601267911
E-mail: muneer.shaikh@siemens.com

Vijayawada

G-2, Shreya Tower, Moghalrajapuram
Nr. Jammichettu Centre
Vijayawada - 520010, Andhra Pradesh
☎ : +91 866 6629933
Mobile: +91 9866463639
E-mail: santosh.p@siemens.com

Vishakhapatnam

Flat No. 302, 48-3-37
Ratna Towers, Sri Nagar
Vishakhapatnam - 530 016, Andhra Pradesh
☎ : +91 891 6462229
Mobile: +91 9849212555
E-mail: kvs.prasad@siemens.com

Vishakhapatnam

Flat No.84, 10-51-10, Mount Moriah Residency
Beside Latha Hospital, Waltair Uplands
Vishkhapatnam - 530003, Andhra Pradesh
☎ : +91 891-2519762
Mobile: +91 9849071221
E-mail: knreddy@siemens.com

Siemens Ltd.
Industry Sector
Building Technologies Division
Low Voltage Global Components
Thane Belapur Road, Airoli Node
Navi Mumbai 400708
Fax: +91 22 27645627
Email: global.components.in@siemens.com

www.siemens.com/industry

Order No.: 102893444
GC-01-001-004
(This replaces ET-01-014-053, ET-01-014-051,
ET-01-014-046, ET-01-014-055,
ET-01-014-059, ET-01-014-045)

Customer Care Toll free no.
1800 22 0987 / 1800 209 0987
Email: adscs.india@siemens.com

Product upgradation is a continuous process. Hence, data in this catalog is subject to change without prior notice. For the latest information, please get in touch with our Sales Offices.