

Contactor relay, 4 NO, 220 V DC, Size S00, screw terminal



Product brand name	SIRIUS
Product designation	contactor relay
Product type designation	3RH2
General technical data	
Size of contactor	S00
Product extension	Yes
<ul style="list-style-type: none"> Auxiliary switch 	
Insulation voltage	690 V
<ul style="list-style-type: none"> with degree of pollution 3 rated value 	
Degree of pollution	3
Surge voltage resistance rated value	6 kV
Protection class IP	IP20
<ul style="list-style-type: none"> on the front 	
Shock resistance at rectangular impulse	10g / 5 ms, 5g / 10 ms
<ul style="list-style-type: none"> at DC 	
Shock resistance with sine pulse	15g / 5 ms, 8g / 10 ms
<ul style="list-style-type: none"> at DC 	
Mechanical service life (switching cycles)	30 000 000
<ul style="list-style-type: none"> of contactor typical 	

<ul style="list-style-type: none"> • of the contactor with added electronics-compatible auxiliary switch block typical 	5 000 000
<ul style="list-style-type: none"> • of the contactor with added auxiliary switch block typical 	10 000 000
Reference code acc. to DIN EN 81346-2	K
Reference code acc. to DIN EN 61346-2	K

Ambient conditions

Installation altitude at height above sea level	
<ul style="list-style-type: none"> • maximum 	2 000 m
Ambient temperature	
<ul style="list-style-type: none"> • during operation 	-25 ... +60 °C
<ul style="list-style-type: none"> • during storage 	-55 ... +80 °C

Main circuit

No-load switching frequency	
<ul style="list-style-type: none"> • at AC 	10 000 1/h
<ul style="list-style-type: none"> • at DC 	10 000 1/h

Control circuit/ Control

Type of voltage of the control supply voltage	DC
Control supply voltage at DC	
<ul style="list-style-type: none"> • rated value 	220 V
Operating range factor control supply voltage rated value of magnet coil at DC	
<ul style="list-style-type: none"> • initial value 	0.8
<ul style="list-style-type: none"> • Full-scale value 	1.1
Closing power of magnet coil at DC	4 W
Holding power of magnet coil at DC	4 W
Closing delay	
<ul style="list-style-type: none"> • at DC 	30 ... 100 ms
Opening delay	
<ul style="list-style-type: none"> • at DC 	7 ... 13 ms
Arcing time	10 ... 15 ms

Auxiliary circuit

Number of NO contacts for auxiliary contacts	4
<ul style="list-style-type: none"> • instantaneous contact 	4
Identification number and letter for switching elements	40 E
Operating current at AC-12 maximum	10 A
Operating current at AC-15	
<ul style="list-style-type: none"> • at 230 V rated value 	10 A
<ul style="list-style-type: none"> • at 400 V rated value 	3 A
<ul style="list-style-type: none"> • at 500 V rated value 	2 A

<ul style="list-style-type: none"> • at 690 V rated value 	1 A
Operating current at 1 current path at DC-12	
<ul style="list-style-type: none"> • at 24 V rated value 	10 A
<ul style="list-style-type: none"> • at 110 V rated value 	3 A
<ul style="list-style-type: none"> • at 220 V rated value 	1 A
<ul style="list-style-type: none"> • at 440 V rated value 	0.3 A
<ul style="list-style-type: none"> • at 600 V rated value 	0.15 A
Operating current with 2 current paths in series at DC-12	
<ul style="list-style-type: none"> • at 24 V rated value 	10 A
<ul style="list-style-type: none"> • at 60 V rated value 	10 A
<ul style="list-style-type: none"> • at 110 V rated value 	4 A
<ul style="list-style-type: none"> • at 220 V rated value 	2 A
<ul style="list-style-type: none"> • at 440 V rated value 	1.3 A
<ul style="list-style-type: none"> • at 600 V rated value 	0.65 A
Operating current with 3 current paths in series at DC-12	
<ul style="list-style-type: none"> • at 24 V rated value 	10 A
<ul style="list-style-type: none"> • at 60 V rated value 	10 A
<ul style="list-style-type: none"> • at 110 V rated value 	10 A
<ul style="list-style-type: none"> • at 220 V rated value 	3.6 A
<ul style="list-style-type: none"> • at 440 V rated value 	2.5 A
<ul style="list-style-type: none"> • at 600 V rated value 	1.8 A
Operating frequency at DC-12 maximum	1 000 1/h
Operating current at 1 current path at DC-13	
<ul style="list-style-type: none"> • at 24 V rated value 	10 A
<ul style="list-style-type: none"> • at 110 V rated value 	1 A
<ul style="list-style-type: none"> • at 220 V rated value 	0.3 A
<ul style="list-style-type: none"> • at 440 V rated value 	0.14 A
<ul style="list-style-type: none"> • at 600 V rated value 	0.1 A
Operating current with 2 current paths in series at DC-13	
<ul style="list-style-type: none"> • at 24 V rated value 	10 A
<ul style="list-style-type: none"> • at 60 V rated value 	3.5 A
<ul style="list-style-type: none"> • at 110 V rated value 	1.3 A
<ul style="list-style-type: none"> • at 220 V rated value 	0.9 A
<ul style="list-style-type: none"> • at 440 V rated value 	0.2 A
<ul style="list-style-type: none"> • at 600 V rated value 	0.1 A
Operating current with 3 current paths in series at DC-13	
<ul style="list-style-type: none"> • at 24 V rated value 	10 A
<ul style="list-style-type: none"> • at 60 V rated value 	4.7 A

<ul style="list-style-type: none"> • at 110 V rated value • at 220 V rated value • at 440 V rated value • at 600 V rated value 	<p>3 A</p> <p>1.2 A</p> <p>0.5 A</p> <p>0.26 A</p>
Operating frequency at DC-13 maximum	1 000 1/h
Design of the miniature circuit breaker	
<ul style="list-style-type: none"> • for short-circuit protection of the auxiliary circuit up to 230 V 	C characteristic: 6 A; 0.4 kA
Contact reliability of auxiliary contacts	1 faulty switching per 100 million (17 V, 1 mA)

UL/CSA ratings

Contact rating of auxiliary contacts according to UL	A600 / Q600
---	-------------

Short-circuit protection

Design of the fuse link	
<ul style="list-style-type: none"> • for short-circuit protection of the auxiliary switch required 	fuse gL/gG: 10 A

Installation/ mounting/ dimensions

Mounting position	+/-180° rotation possible on vertical mounting surface; can be tilted forward and backward by +/- 22.5° on vertical mounting surface
Mounting type	screw and snap-on mounting onto 35 mm standard mounting rail
Height	57.5 mm
Width	45 mm
Depth	73 mm
Required spacing	
<ul style="list-style-type: none"> • with side-by-side mounting <ul style="list-style-type: none"> — forwards — upwards — downwards — at the side • for grounded parts <ul style="list-style-type: none"> — forwards — upwards — at the side — downwards • for live parts <ul style="list-style-type: none"> — forwards — upwards — downwards — at the side 	<p>10 mm</p> <p>10 mm</p> <p>10 mm</p> <p>0 mm</p> <p>10 mm</p> <p>10 mm</p> <p>6 mm</p> <p>10 mm</p> <p>10 mm</p> <p>10 mm</p> <p>6 mm</p>

Connections/Terminals

Type of electrical connection	
--------------------------------------	--





<ul style="list-style-type: none"> • for auxiliary and control current circuit 	screw-type terminals
Type of connectable conductor cross-sections <ul style="list-style-type: none"> • for auxiliary contacts <ul style="list-style-type: none"> — single or multi-stranded — finely stranded with core end processing • at AWG conductors for auxiliary contacts 	2x (0,5 ... 1,5 mm ²), 2x (0,75 ... 2,5 mm ²), 2x 4 mm ² 2x (0.5 ... 1.5 mm ²), 2x (0.75 ... 2.5 mm ²) 2x (20 ... 16), 2x (18 ... 14), 2x 12





Safety related data

B10 value <ul style="list-style-type: none"> • with high demand rate acc. to SN 31920 	1 000 000; With 0.3 x I _e
Proportion of dangerous failures <ul style="list-style-type: none"> • with low demand rate acc. to SN 31920 • with high demand rate acc. to SN 31920 	40 % 73 %
Failure rate [FIT] <ul style="list-style-type: none"> • with low demand rate acc. to SN 31920 	100 FIT
Product function <ul style="list-style-type: none"> • positively driven operation acc. to IEC 60947-5-1 	Yes
T1 value for proof test interval or service life acc. to IEC 61508	20 y

Certificates/approvals

General Product Approval	Functional Safety/Safety of Machinery	Declaration of Conformity
 CCC  CSA  UL 	Type Examination	 EG-Konf.

Test Certificates	Marine / Shipping
Type Test Certificates/Test Report	 ABS  BUREAU VERITAS  GL  LRS  PRS

Marine / Shipping	other
 RINA  RMRS  TYPE-APPROVED PRODUCT DNV-GL DNVGL.COM/AF	Confirmation  VDE

Further information

Information- and Downloadcenter (Catalogs, Brochures,...)

<http://www.siemens.com/industrial-controls/catalogs>

Industry Mall (Online ordering system)

<https://mall.industry.siemens.com/mall/en/en/Catalog/product?mlfb=3RH2140-1BM40>

Cax online generator

<http://support.automation.siemens.com/WW/CAXorder/default.aspx?lang=en&mlfb=3RH2140-1BM40>

Service&Support (Manuals, Certificates, Characteristics, FAQs,...)

<https://support.industry.siemens.com/cs/ww/en/ps/3RH2140-1BM40>

Image database (product images, 2D dimension drawings, 3D models, device circuit diagrams, EPLAN macros, ...)

http://www.automation.siemens.com/bilddb/cax_de.aspx?mlfb=3RH2140-1BM40&lang=en

Characteristic: Tripping characteristics, I^t, Let-through current

<https://support.industry.siemens.com/cs/ww/en/ps/3RH2140-1BM40/char>

Further characteristics (e.g. electrical endurance, switching frequency)

<http://www.automation.siemens.com/bilddb/index.aspx?view=Search&mlfb=3RH2140-1BM40&objecttype=14&gridview=view1>

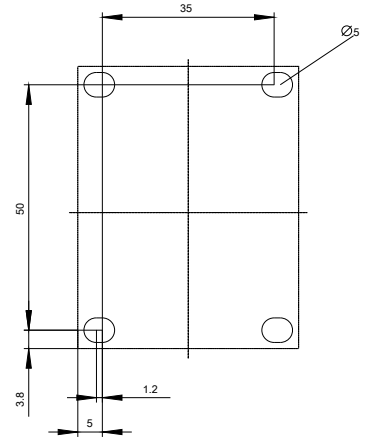
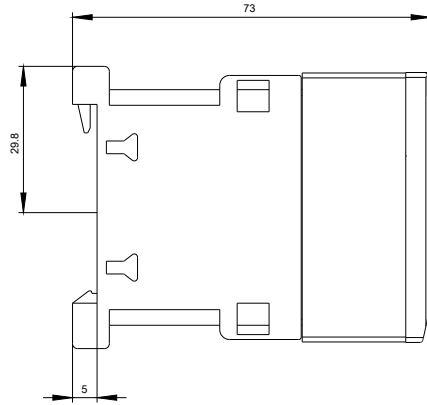
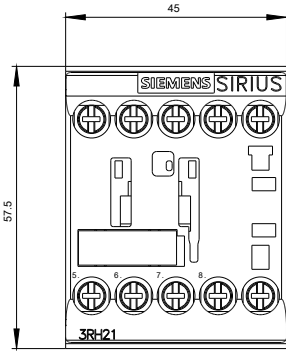

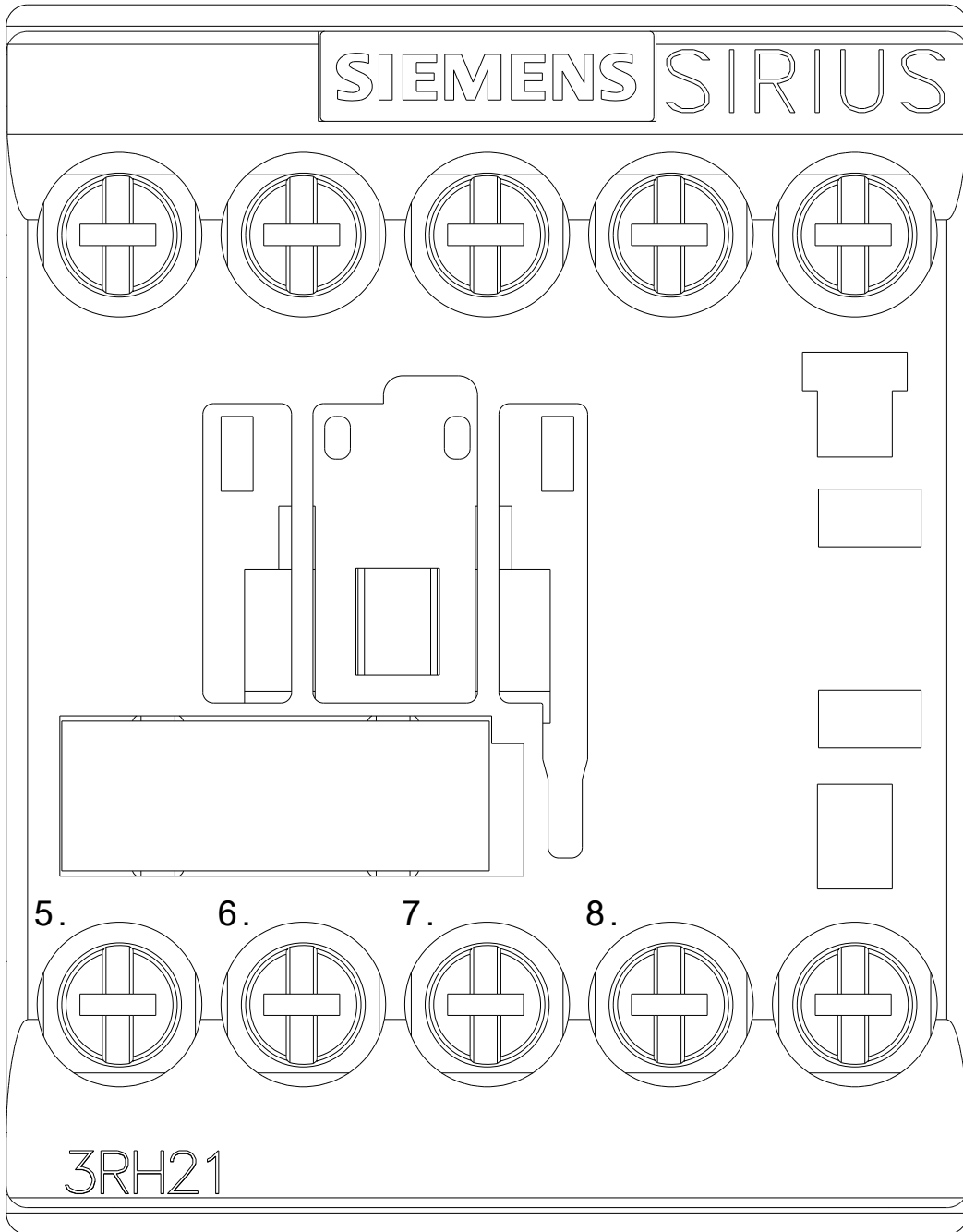

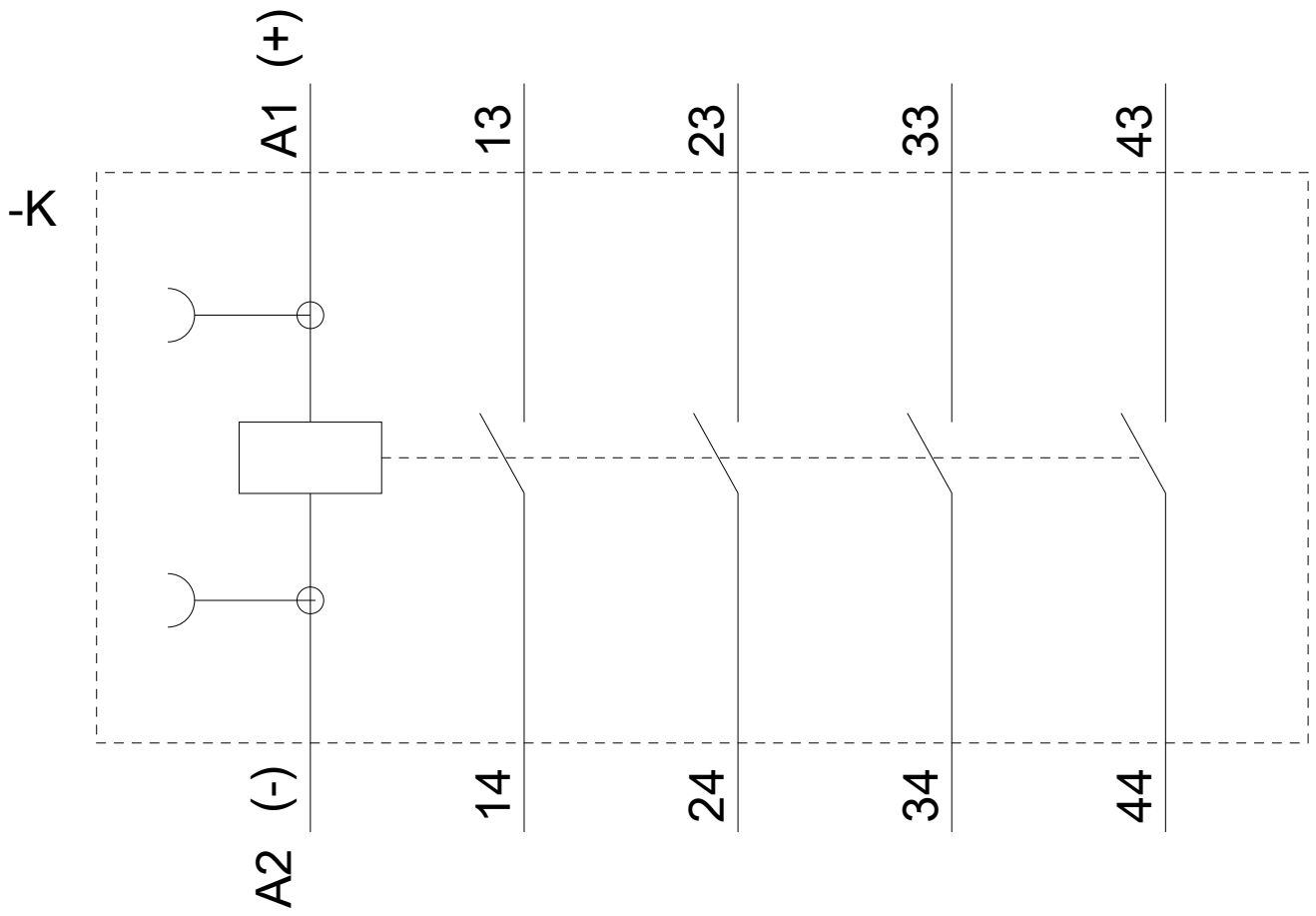

last modified:

07/20/2018